

perfecta

Alarm control panel

PERFECTA 64 M

Firmware version 2.04

EN

CE



INSTALLER MANUAL

perfecta_64_M_i_en 06/25

Satel®

SATEL sp. z o.o. • ul. Budowlanych 66 • 80-298 Gdańsk • POLAND
tel. +48 58 320 94 00
www.satel.pl

IMPORTANT

The security alarm system should be installed by qualified personnel.

Prior to installation, please read carefully this manual in order to avoid mistakes that can lead to malfunction or even damage to the equipment.

Disconnect power before making any electrical connections.

Changes, modifications or repairs not authorized by the manufacturer shall void your rights under the warranty.

The nameplate of the control panel should be stuck to the enclosure. The symbols on the nameplate mean:

 The device meets the requirements of the applicable EU directives.

 The device is designed for indoor installation.

 The device must not be disposed of with other municipal waste. It should be disposed of in accordance with the existing rules for environment protection (the device was placed on the market after 13 August 2005).

 The device meets the technical regulations of the Eurasian Customs Union.

 Alternating current.

 Direct current.

SATEL aims to continually improve the quality of its products, which may result in changes in their technical specifications and software. Current information about the changes being introduced is available on our website.

Please visit us at:
<https://support.satel.pl>

Hereby, SATEL sp. z o.o. declares that the radio equipment type PERFECTA 64 M is in compliance with Directive 2014/53/EU. The full text of the EU declaration of conformity is available at the following internet address: www.satel.pl/ce

Signs in this manual

 Caution – information on the safety of users, devices, etc.

 Note – suggestion or additional information.

Changes made to the firmware version 2.04

Devices	IP zones supported by the ETHM-1 Plus module.
Options	New option: <i>Arm./Disarm./Clear. sign. from zones and keyfobs only.</i> It is used to specify when the outputs with the <i>Arm/Disarm/clear sign.</i> option enabled should signal arming / disarming the system or clearing alarm etc.
Zones	Programmable value of end-of-line resistors.
Outputs	New output function: 27. <i>Latch</i>
Remote update	Capability to start a remote firmware update in the PERFECTA SOFT program and the keypad.

Changes made to the firmware version 2.03

Devices	<p>New functions supported by the ETHM-1 Plus module:</p> <ul style="list-style-type: none">– programming the alarm system in the PERFECTA SOFT program via Ethernet,– operating the alarm system in the PERFECTA CONTROL app via Ethernet. <p>New ABAX 2 devices supported:</p> <ul style="list-style-type: none">– AFD-200 wireless water flood detector,– APB-210 wireless control button,– APT-210 bidirectional keyfob,– ART-210 wireless radiator thermostat.
----------------	---

Changes made to the firmware version 2.02

GSM phone	<p>New <i>SMS over SGS</i> option. It is used to determine whether the control panel is to send / receive SMS messages over SGS.</p> <p>New <i>SMS restarting the phone</i> parameter. It is used to program a SMS control command that restarts the GSM phone.</p>
Devices	New module supported: ETHM-1 Plus.
Reporting	<p>New events transmission path: Ethernet. Installation of the ETHM-1 Plus module required.</p> <p>New reporting method: <i>Dual path reporting.</i> It is used to report events as required by the EN 50136 standard. Installation of the ETHM-1 Plus module required.</p> <p>New <i>Legacy SIA</i> option for the SIA format. It is used to determine whether the control panel is to send events in accordance with the older standard of the SIA format or the newer one.</p> <p>If the ETHM-1 Plus module is connected to the control panel, the <i>GPRS</i> key parameter name is replaced by <i>ETHM/GPRS</i> key.</p>

User menu

Symbols of the APT-210 keyfob buttons are included in the names of the functions used to program keyfob buttons.

If the ETHM-1 Plus module is connected to the control panel, the 7.IMEI/ID/MAC.. function is available instead of 7.IMEI/ID.

The function is used to check the module's MAC address, local address and public address.

Changes made to the firmware version 2.01**Outputs**

New output types dedicated to roller shutter control: 25. *Roller up* and 26. *Roller down*.

New *Not controlled by arming* option for the 25. *Roller up* and 26. *Roller down* outputs. It is used to define whether arming / disarming the partition is to control the output.

New *Blocking timers* parameter for the 25. *Roller up* and 26. *Roller down* outputs. It is used to select the timers that determine when arming / disarming the partition does not control the output.

User functions

New 5.*Others* submenu in the 9.*Tests* submenu.

New 1.*Zones* function in the 5.*Others* submenu. It is used to check the zone status.

New 2.*Card test* function in the 5.*Others* submenu. It is used to check the proximity card number.

CONTENTS

1. Introduction.....	5
2. Features	5
3. Keypads.....	7
3.1 PRF-LCD keypad	8
4. Expansion modules	8
5. Wireless devices.....	9
5.1 ABAX 2 wireless devices.....	9
5.1.1 Keypad	9
5.1.2 Detectors	9
5.1.3 Sirens	10
5.1.4 Hardwired zone / output expanders	10
5.1.5 Others.....	10
5.2 MICRA wireless devices.....	10
5.2.1 Keypad	10
5.2.2 Detectors	10
5.2.3 Siren	11
5.2.4 Others.....	11
6. System installation.....	11
6.1 Installation plan	11
6.2 Estimation of the system current consumption	11
6.3 Cabling.....	12
6.4 Installation of control panel.....	12
6.4.1 Description of the mainboard	13
6.5 Installing the MICRA wireless system module	14
6.6 Connecting devices to the communication bus.....	15
6.6.1 Connecting keypads.....	16
6.6.2 Connecting the Ethernet communication module	17
6.6.3 Connecting the ABAX 2 wireless system controller	18
6.6.4 Connecting 433 MHz keyfobs receiver expansion module	19
6.6.5 Connecting the hardwired zone expanders.....	19
6.6.6 Connecting the hardwired output expanders	21
6.6.7 Connecting the proximity card arm/disarm devices	23
6.7 Connecting detectors and other devices to the zones	25
6.8 Connecting the sirens.....	28
6.9 Connecting the microphone.....	28
6.10 Connecting the power and starting the control panel	28
6.10.1 Main power source	28
6.10.2 Backup power source	29
6.10.3 Control panel power-up / start-up procedure	29
6.10.4 Starting the service mode.....	29
6.10.5 Emergency procedure of the control panel start-up	30
6.10.6 First steps after starting-up the control panel.....	30
6.11 Programming addresses for the hardwired keypads.....	30
6.11.1 Programming the address by means of the service function	31
6.11.2 Programming the address without entering the service mode.....	31
6.12 Identifying devices.....	31
6.12.1 Identifying devices by means of the keypad	32
6.12.2 Identifying devices by means of the PERFECTA SOFT program	32
6.13 Installing the SIM card.....	32
6.14 Connecting the computer to the control panel	33
6.15 Installing the ABAX 2 wireless devices.....	33
6.15.1 Registering the ABAX 2 devices to the controller	33

- 6.16 Installing the MICRA wireless devices 37
 - 6.16.1 Registering the MICRA devices to the controller 37
- 7. Numeration of zones and outputs in the system 40
 - 7.1 Numeration of zones..... 40
 - 7.1.1 Hardwired zones..... 40
 - 7.1.2 Wireless zones 40
 - 7.2 Numeration of outputs..... 40
 - 7.2.1 Hardwired outputs 40
 - 7.2.2 Wireless outputs 40
- 8. Specifications..... 40
 - 8.1 Control panel 40
 - 8.2 PRF-LCD keypad..... 41
- 9. Manual update history 41

1. Introduction

This manual describes the PERFECTA 64 M control panel and how it should be installed. In addition, the manual provides information about devices compatible with the control panel and how they are to be connected.

The PERFECTA 64 M alarm control panel meets the requirements of the following standards: EN 50131-1 Grade 2, EN 50131-3 Grade 2, EN 50131-6 Grade 2, EN 50130-4 and EN 50130-5 Class II.

2. Features

System partitioning

- 4 partitions to protect 4 different areas.
- Independent partitions or partitions with intersections (capability to assign a zone to several partitions).

Zones

- 8 programmable hardwired zones on the control panel mainboard:
 - support for NO and NC type detectors, as well as roller shutter and shock detectors,
 - support for Single EOL and Double EOL configuration,
 - programmable value of end-of-line resistors.
- Electrical protection of all zones.
- Maximum number of programmable zones: 64.
- 20 zone types.

IP zones

- Receiving HTTP notifications sent by IP cameras if the ETHM-1 Plus module is installed in the system.

Outputs

- 4 programmable hardwired outputs on the control panel mainboard:
 - 2 high-current outputs,
 - 2 low-current outputs, OC type.
- Maximum number of programmable outputs: 64.
- 4 outputs dedicated for operating the MICRA wireless system sirens (output numbers: 13-16).
- 27 output functions.
- 2 power supply outputs on the control panel mainboard.
- Electrical protection of all outputs.

Communication bus

- Capability to connect keypads and expansion modules.
- Electrical protection of communication bus.

Communication connector

- Connector for the PERFECTA-RF module (MICRA wireless system module).

Wireless devices

- Capability to install wireless devices in the system after connecting one of the following modules to the control panel:
 - ACU-220 / ACU-280 – ABAX 2 system devices (up to 4 keypads / up to 48 detectors, sirens or other devices),
 - PERFECTA-RF – MICRA system devices (up to 4 keypads / up to 64 detectors / up to 4 sirens).

Keyfobs

- Capability to use keyfobs for alarm system operation after connecting one of the following modules to the control panel:
 - ACU-220 / ACU-280 – ABAX 2 system keyfobs (APT-200 / APT-210),
 - PERFECTA-RF – MICRA system keyfobs (MPT-350),
 - INT-RX-S – 433 MHz keyfobs (MPT-350 / T-4 / T-2 / T-1).

Communication

- Built-in cellular communicator operating in the 2G and 4G networks.
- Dual SIM support (nano-SIM).

Reporting

- Reporting events to two monitoring stations.
- Support for Contact ID and SIA communication formats.
- Sending event codes to the monitoring station via:
 - cellular data network (LTE/EDGE/GPRS data transmission),
 - GSM voice channel,
 - SMS messages.
- Sending event codes to the monitoring station via Ethernet if the ETHM-1 Plus module is installed in the system.
- Defining priority for various ways to report events.

Messaging

- Event notification to 8 phone numbers in the form of:
 - 16 voice messages,
 - SMS messages with automatically generated content.
- Built-in voice module to enable playback of voice messages for the needs of telephone messaging.
- Informing users of the PERFECTA CONTROL application about events using push notifications.

SMS control

- Alarm system control using SMS messages.

PERFECTA CONTROL mobile application

- Operating the alarm system from mobile devices:
 - control of the alarm system,
 - checking the alarm system status.

Acoustic alarm verification

- Possibility of listening in to sounds from the protected premises over the telephone.

Event log

- 3584 events.

Users

- 62 users.
- Capability to assign to the user:
 - code,
 - proximity card (any 125 kHz passive transponder in the form of a card, tag, etc.),
 - keyfob.
- Authority level determining the scope of access to the system.

Timers

- 8 timers to automatically:
 - arm/disarm the partitions,
 - control the outputs (switching the lights on/off, watering the garden, etc.).

Programming

- Local programming:
 - keypad,
 - computer with the PERFECTA SOFT program installed, connected to the control panel RS-232 (TTL) port.
- Remote programming in the PERFECTA SOFT program via cellular network (LTE/EDGE/GPRS data transmission) or via Ethernet (installation of the ETHM-1 Plus module required).

Control panel firmware update

- Local update from a computer connected to the RS-232 (TTL) port of the control panel.
- Remote update using the UPSERV update server via cellular network (LTE/EDGE/GPRS data transmission) or via Ethernet (installation of the ETHM-1 Plus module required).

Built-in power supply

- Switching-mode power supply 12 V / 2 A.
- Short-circuit protection.
- Battery charging circuit.
- Battery status supervision and low battery disconnect system.

3. Keypads

SATEL offers the following keypads for PERFECTA 64 M alarm control panel:

PRF-LCD – hardwired keypad with mechanical keys,

INT-KSG2R – hardwired keypad with touch keys,

INT-TSG2 – hardwired touchscreen keypad,

INT-TSG2R – hardwired touchscreen keypad,

INT-TSH2 – hardwired touchscreen keypad,

INT-TSH2R – hardwired touchscreen keypad,

INT-TSH210 – hardwired touchscreen keypad,

PRF-LCD-A2 – wireless keypad with mechanical keys and built-in proximity card reader (ACU-220 / ACU-280 module must be connected),

PRF-LCD-WRL – wireless keypad with mechanical keys (PERFECTA-RF module must be connected).



The alarm system should include at least one keypad.

The wireless keypads respond to the user actions more slowly than the wired ones.

For information on the INT-KSG2R, INT-TSG2, INT-TSG2R, INT-TSH2, INT-TSH2R, INT-TSH210, PRF-LCD-A2 and PRF-LCD-WRL keypads, please refer to the manuals included with these keypads.

3.1 PRF-LCD keypad

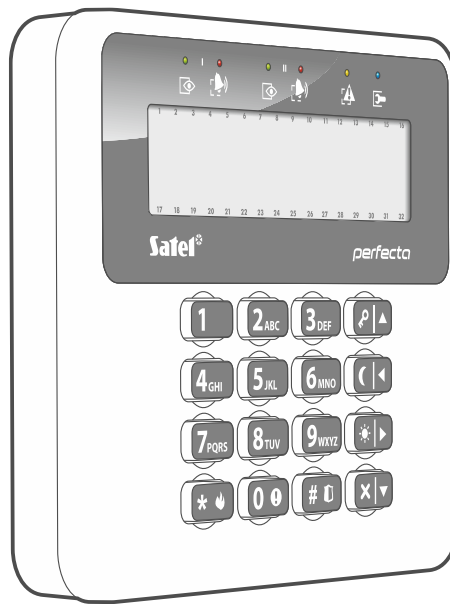

Fig. 1. PRF-LCD keypad.

- Display 2 x 16 characters with backlight.
- LEDs indicating the status of the partitions and the system.
- 12 keys, bearing designations according to telephone standard and intended for entering data.
- 4 additional keys for menu navigation and arming/disarming.
- Backlit keys.
- Built-in sounder.
- Tamper protection against enclosure opening and removal from mounting surface.

4. Expansion modules

ETHM-1 Plus – Ethernet communication module It is used to report events, program and operate the alarm system via Ethernet.



If the ETHM-1 Plus module is connected to the control panel, communication via Ethernet has the priority. The cellular data network is used as the backup communication path.

ACU-220 / ACU-280 – ABAX 2 wireless system controller. It is used to expand the alarm system with ABAX 2 wireless devices. It enables the users to control the alarm system using the ABAX 2 keyfobs. Required firmware version of the controller: 6.06.

PERFECTA-RF – MICRA wireless system module. It is used to expand the alarm system with MICRA wireless devices. It enables the users to control the alarm system using the MICRA keyfobs.

INT-RX-S – 433 MHz keyfobs receiver expansion module. Enables users to control the alarm system using the 433 MHz keyfobs.



You can install only one of the following devices: ACU-220 / ACU-280 controller, PERFECTA-RF module or INT-RX-S expander. The ABAX 2 and MICRA wireless devices cannot be used simultaneously in the system.

INT-E – zone expander. It is used to expand the system with 8 programmable hardwired zones.

INT-O / INT-ORS – output expander. It is used to expand the system with 8 programmable hardwired outputs.

INT-CR / INT-IT-2 – proximity card arm/disarm device. It is used to arm / disarm and clear alarms in partitions by means of proximity cards / tags.

5. Wireless devices

The list of devices that can be installed in the system varies depending on the expansion module connected to the alarm control panel.

5.1 ABAX 2 wireless devices

The ACU-220 / ACU-280 controller supports the wireless devices listed below.

5.1.1 Keypad

PRF-LCD-A2 - wireless keypad.

5.1.2 Detectors

ACD-220 - wireless curtain detector.

ACMD-200 - wireless carbon monoxide detector.

ADD-200 - wireless outdoor dusk and temperature detector.

AFD-200 - wireless water flood detector.

AGD-200 - wireless glass-break detector.

AOCD-260 - wireless outdoor dual technology curtain detector.

AOD-210 - wireless outdoor dual technology motion detector.

APD-200 - wireless passive infrared detector.

APD-200 Pet - wireless passive infrared detector with pet immunity up to 20 kg.

APMD-250 - wireless dual technology motion detector.

ASD-200 - wireless smoke and heat detector.

ASD-250 - wireless smoke detector.

AXD-200 - wireless multipurpose detector, which can work as:

AFD-200 - water flood detector,

AMD-200 - magnetic contact,

AMD-201 - dual channel magnetic contact,

AMD-202 - magnetic contact with input for roller shutter detector,

- ARD-200** - reorientation detector,
- ATD-200** - temperature detector,
- AVD-200** - shock detector and magnetic contact,
- ATX-220** - hardwired zone expander: 2 x NC,
- ATX-230** - hardwired zone expander: NC and roller shutter.

5.1.3 Sirens

- ASP-200** - wireless outdoor siren.
- ASP-215** - wireless indoor siren.

5.1.4 Hardwired zone / output expanders

- ACX-210** - miniature hardwired zone / output expander.
- ACX-220** - hardwired zone / output expander.

5.1.5 Others

- APB-200** - wireless panic button.
- APB-210** - wireless control button.
- ASW-200** - smart plug.
- ASW-210** - flush-mounted wireless two-channel 230 VAC controller.
- ARF-200** - radio signal level tester.
- ART-200** - wireless radiator thermostat.
- ART-210** - wireless radiator thermostat.
- ARU-200** - radio signal repeater.

5.2 MICRA wireless devices

The PERFECTA-RF module supports the wireless devices listed below.

5.2.1 Keypad

- PRF-LCD-WRL** - wireless keypad.

5.2.2 Detectors

- MFD-300** - wireless water flood detector.
- MGD-300** - wireless glass-break detector.
- MMD-300** - wireless magnetic contact.
- MMD-302** - wireless magnetic contact with input for roller shutter detector.
- MPD-300** - wireless passive infrared detector.
- MPD-310** - wireless passive infrared detector.
- MPD-310 Pet** - wireless passive infrared detector with pet immunity up to 20 kg.
- MRU-300** - radio signal repeater.
- MSD-300** - wireless smoke and heat detector.
- MSD-350** - wireless smoke detector.
- MXD-300** - wireless multipurpose detector.



The MPD-310 and MPD-310 Pet detectors are identified as the MPD-300 detector.

The MSD-350 detector is identified as the MSD-300 detector.

The MXD-300 detector is identified as the MMD-302 detector.

5.2.3 Siren

MSP-300 - wireless outdoor siren.

5.2.4 Others

MPB-300 - wireless panic button.

MRU-300 - radio signal repeater.



The MPB-300 button is identified as the MMD-300 detector or the MPT-350 keyfob. The operating mode must be selected, before the button is registered to the wireless system.

The MRU-300 repeater is identified as the MMD-300 detector. When registering the repeater to the control panel and programming it, proceed in the same way as with a detector. You do not have to register the repeater to the control panel but its operation will not be supervised if unregistered (power failures, lack of presence or tamper will not be reported).

6. System installation



Disconnect power before making any electrical connections.

The following tools will be useful during installation:

- blade screwdriver 2.5 mm,
- Phillips screwdriver,
- precision pliers,
- flat nose pliers,
- drill with a set of drill bits.

6.1 Installation plan

The installation must be preceded by preparation of a plan of the security alarm system. Draw up a plan of the premises and mark on it all the devices that are to be included in the alarm system: control panel, keypads, detectors, sirens, expansion modules etc. Thick walls, metal partitions, etc. decrease the range of cellular signal. Keep this in mind when choosing the installation place for control panel. The control panel and other alarm system components should be installed within the protected area.

If the PERFECTA-RF module is connected to the control panel, take into consideration the communication range of the MICRA wireless devices when selecting the place of installation for the control panel.

6.2 Estimation of the system current consumption

At the security system planning stage you should sum up the currents consumed by all devices included in the system (control panel mainboard, keypads, expansion modules, detectors, sirens, etc.). The calculation should take into account the battery charging current. If the sum of currents exceeds the maximum output current of the control panel power supply an additional power supply should be used.

The sum of currents consumed by the devices connected to the power supply (expander with power supply) must not exceed the power supply output current.

If you plan to connect devices to particular power outputs (of the control panel, expander with power supply, etc.), remember that the sum of currents consumed by the connected devices must not exceed the maximum current carrying capacity of those outputs.

6.3 Cabling

It is recommended that an unshielded non-twisted cable be used for making electric connections between devices included in the system.



If you use the twisted-pair type of cable, remember that CLK (clock) and DTA (data) signals must not be sent through one pair of twisted conductors.

Select cross-section of the power wires so that the supply voltage drop between the power supply and the powered device should not exceed 1 V as against the output voltage.

In order to guarantee correct functioning of the system components it is important that resistance and capacitance of the signal wires be as low as possible. When the distances between the devices are greater, several wires connected in parallel may have to be used for each signal, in order to reduce conductor resistance. This, however, may lead in consequence to an increase in conductor capacitance. Too high resistance or capacitance of the cables connecting the control panel to keypads or expansion modules can prevent the devices from working correctly (e.g. the control panel will be unable to identify devices, absence of devices will be reported, etc.). When selecting the length of cables, follow recommendations set out in sections on connection of particular types of devices.

Avoid running the cables in parallel to or in close vicinity of the 230 VAC wires, as this may result in malfunctioning of the system.

6.4 Installation of control panel



The control panel mainboard contains electronic components sensitive to electric charges.

Before connecting the mainboard to power source (battery, alternating voltage from transformer), you must first complete all the installation work with hardwired devices (connection of keypads, expansion modules, detectors etc.).

The control panel should be installed indoors, in spaces with normal humidity of air. A 230 VAC power circuit with protective grounding must be available at the installation place. The control panel must be protected against unauthorized access. The installer should provide protection for the users and service personnel by using a suitable device enclosure. It is recommended to install the control panel in a plastic enclosure.



Do not install the control panel in a metal enclosure if the PERFECTA-RF module is to be used or another radio device is to be installed in the control panel enclosure.

6.4.1 Description of the mainboard

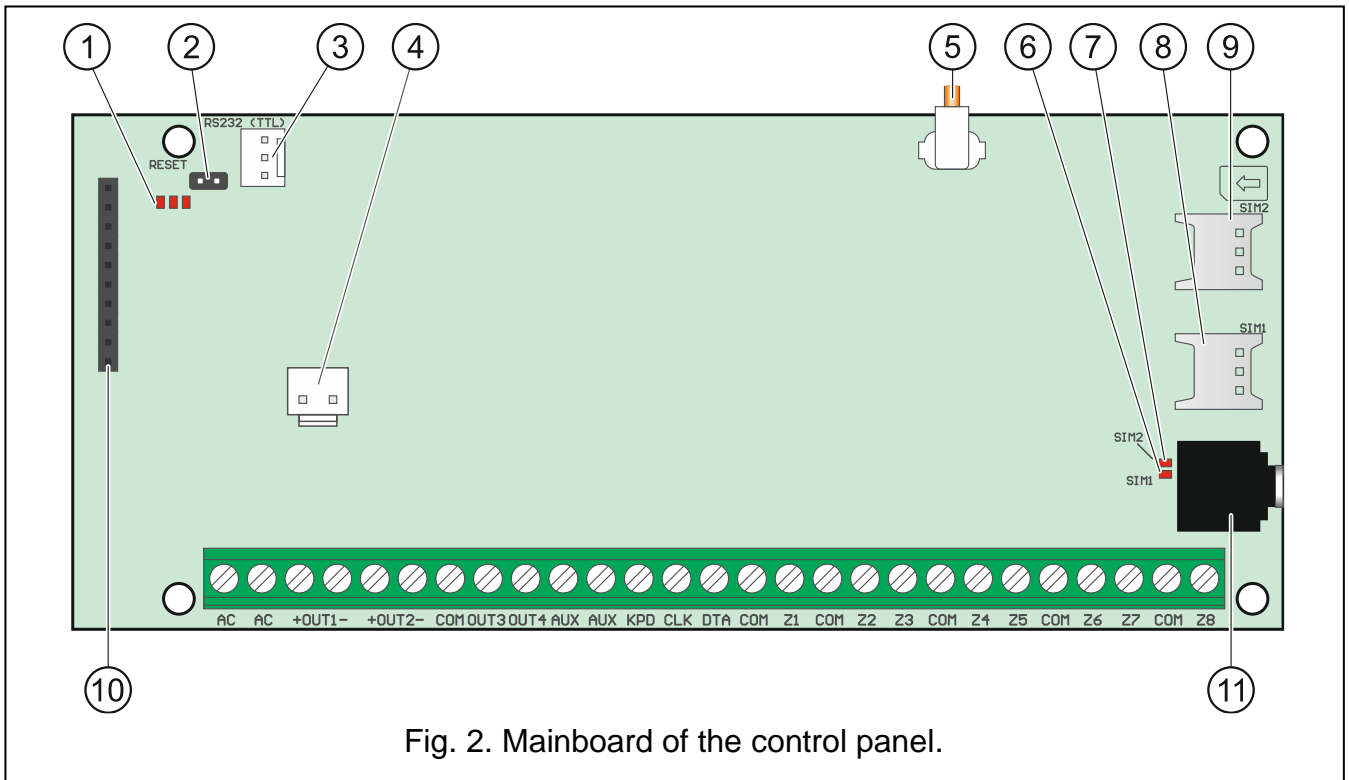

Fig. 2. Mainboard of the control panel.

- ① LED indicators:
 - left – ON when the listen-in function is in use.
 - center – ON when the battery is being tested.
 - right – ON when the cellular communicator is on.
 - ② RESET pins for emergency starting the control panel (see: “Emergency procedure of the control panel start-up” p. 30).
 - ③ RS-232 (TTL) port.
 - ④ connector for battery connection wires. The wires are included in the set (Fig. 3).
 - ⑤ cable terminated with a connector for antenna. If the control panel is installed in a plastic enclosure, you can use an antenna that can be installed inside the enclosure (the antenna is delivered with the control panel). If the control panel is installed in a metal enclosure, use an antenna that can be installed on the enclosure or at a certain distance from the enclosure.
 - ⑥ SIM1 LED. The LED is on, when the card installed in the SIM 1 slot is active.
 - ⑦ SIM2 LED. The LED is on, when the card installed in the SIM 2 slot is active.
- i** | *The SIM1 or SIM2 LED is on even if no card is installed.*
- ⑧ SIM1 slot in which the first SIM card is to be installed.
 - ⑨ SIM2 slot in which the second SIM card is to be installed.
- i** | *Inserting the SIM card into its slot before programming the card PIN code in the control panel is not recommended.*
- ⑩ communication connector for connecting the PERFECTA-RF module.
 - ⑪ mini-jack socket for connecting microphone.

Description of terminals

AC	- power input (18 VAC).
+OUT1-, +OUT2-	- programmable high-current outputs. +12 VDC voltage is always present at the “+” terminal. The “-” terminal is either shorted to or disconnected from the common ground, depending on the output status (active/inactive) and polarity.
OUT3, OUT4	- programmable low-current outputs, OC type (disconnected from common ground / shorted to common ground).
COM	- common ground.
AUX	- +12 VDC power output.
KPD	- +12 VDC power output.
DTA	- communication bus data.
CLK	- communication bus clock.
Z1...Z8	- zones.

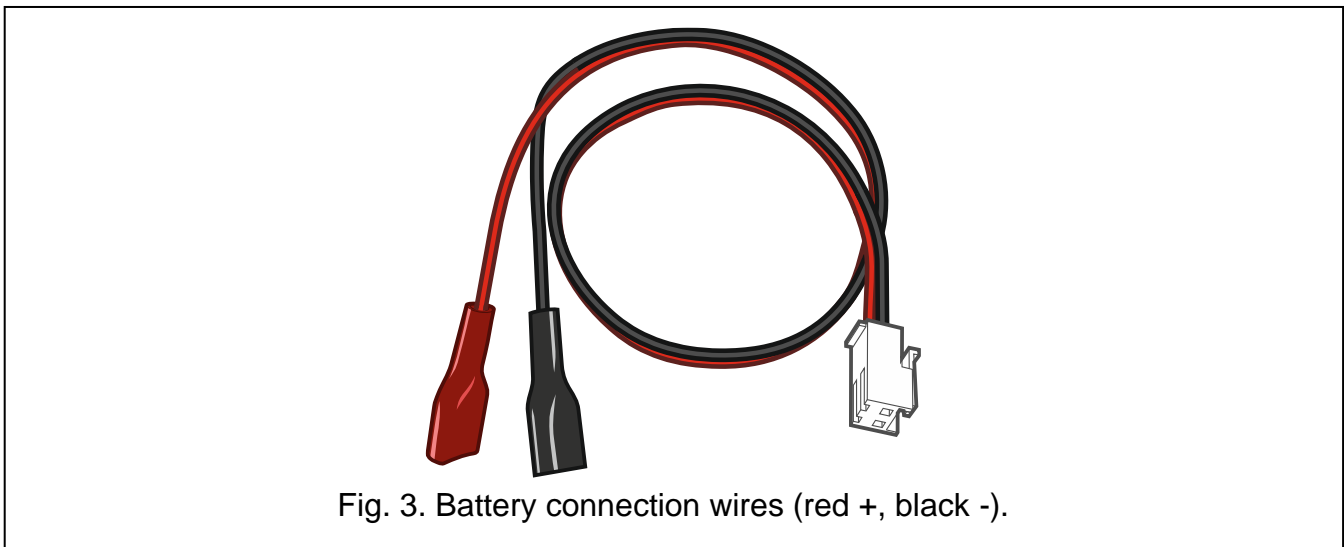

Fig. 3. Battery connection wires (red +, black -).

6.5 Installing the MICRA wireless system module



If the PERFECTA-RF module is to be used, do not install the ACU-220 / ACU-280 controller or the INT-RX-S expander. These devices cannot be used simultaneously.

If you install the PERFECTA-RF module on the control panel mainboard, you will be able to:

- install in the alarm system:
 - up to 4 wireless keypads,
 - up to 64 wireless detectors (up to 64 wireless zones),
 - up to 4 wireless sirens (up to 4 wireless outputs),
- assign MICRA keyfobs to users (up to 62 keyfobs).

Install the PERFECTA-RF module in the slot on the electronics board as shown in Figure 4.

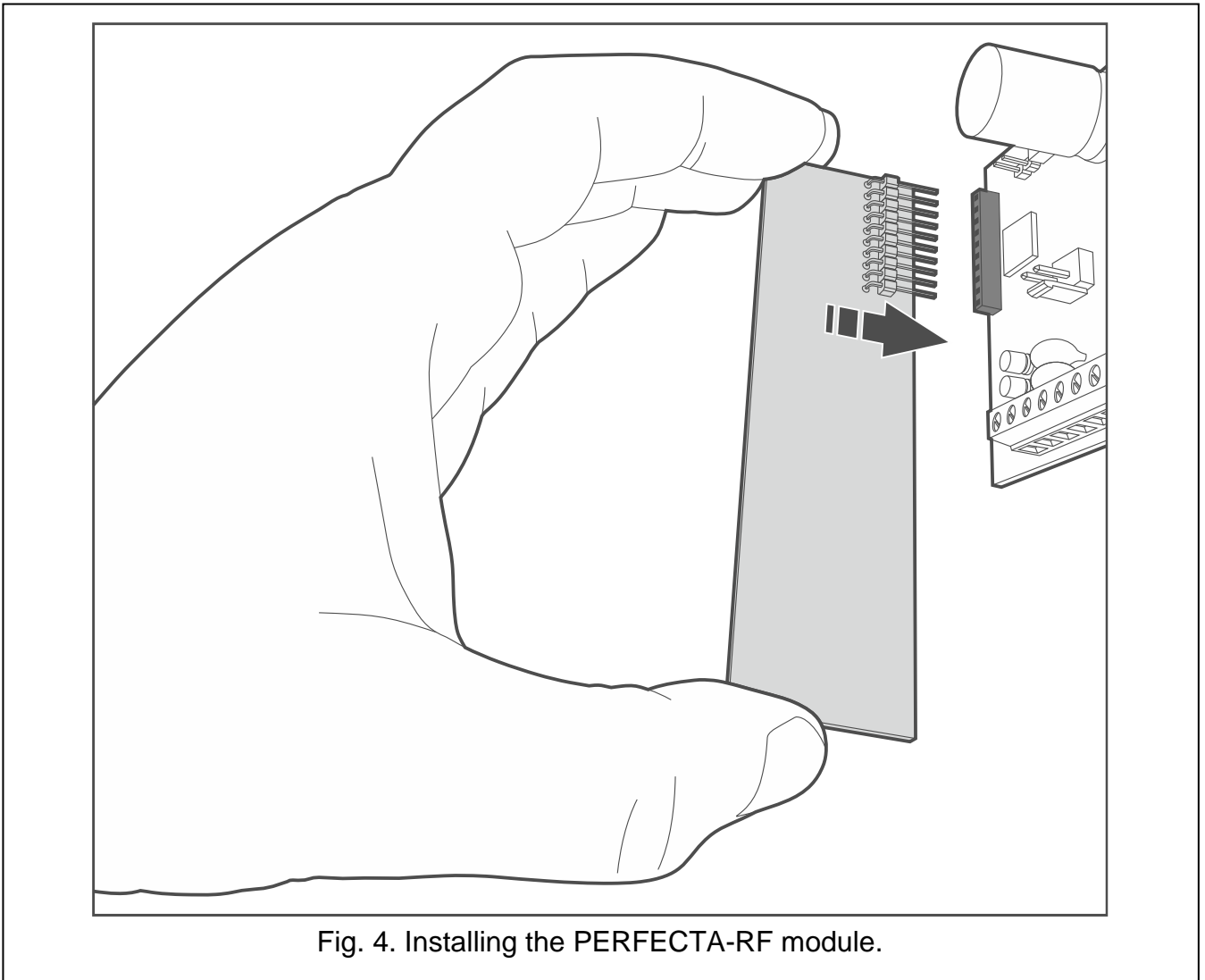

Fig. 4. Installing the PERFECTA-RF module.

6.6 Connecting devices to the communication bus



The bus wires must be run in one cable.

The total length of the expander bus may not exceed 600 m.

The device can be powered directly from the control panel, if the distance to the control panel does not exceed 300 m. Where the distance is greater, another power source must be provided for the device (additional power supply).

	CLK	DTA	COM
Distance	Number of wires		
up to 300 m	1	1	1
300-600 m	2	2	2

Table 1. The number of wires required for correct connection of the device to the expander bus if conductors with 0.5 mm diameter are used.

For most devices to be connected to the communication bus, setting of a suitable address is required. Two devices must not share the same address (otherwise their identification will be

impossible). For information on the requirements related to address setting, please refer to the sections describing how specific devices are to be connected.

6.6.1 Connecting keypads

The control panel supports up to 4 keypads. These can be either wired or wireless keypads (the wireless ones can only be installed after starting the control panel). Addresses of the keypads must be set within the range from 0 to 3 (see “Programming addresses for the hardwired keypads” p. 30).



It is not recommended to install more than two PRF-LCD-A2 wireless keypads in the system.

Mounting the PRF-LCD keypad

The keypad is designed for indoor installation. The place of installation should be readily accessible to the system users.

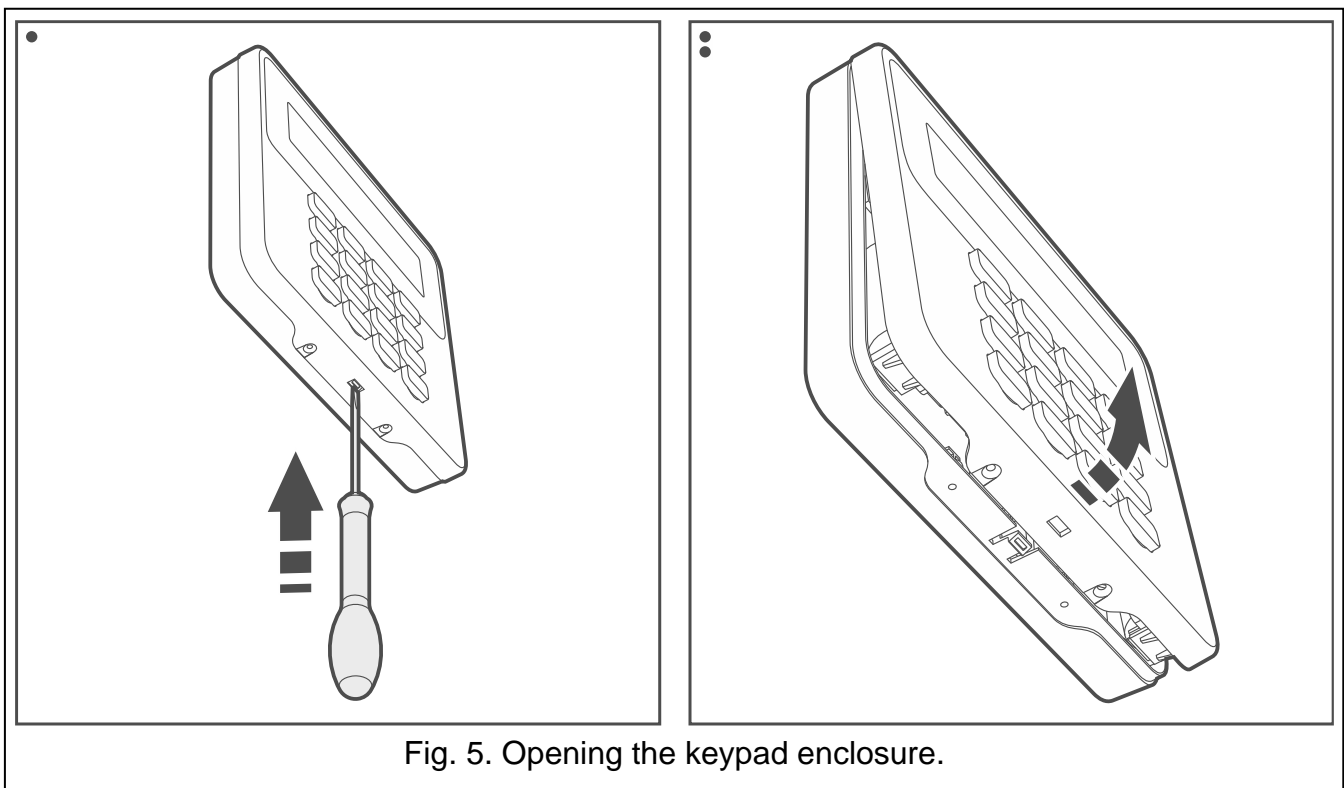
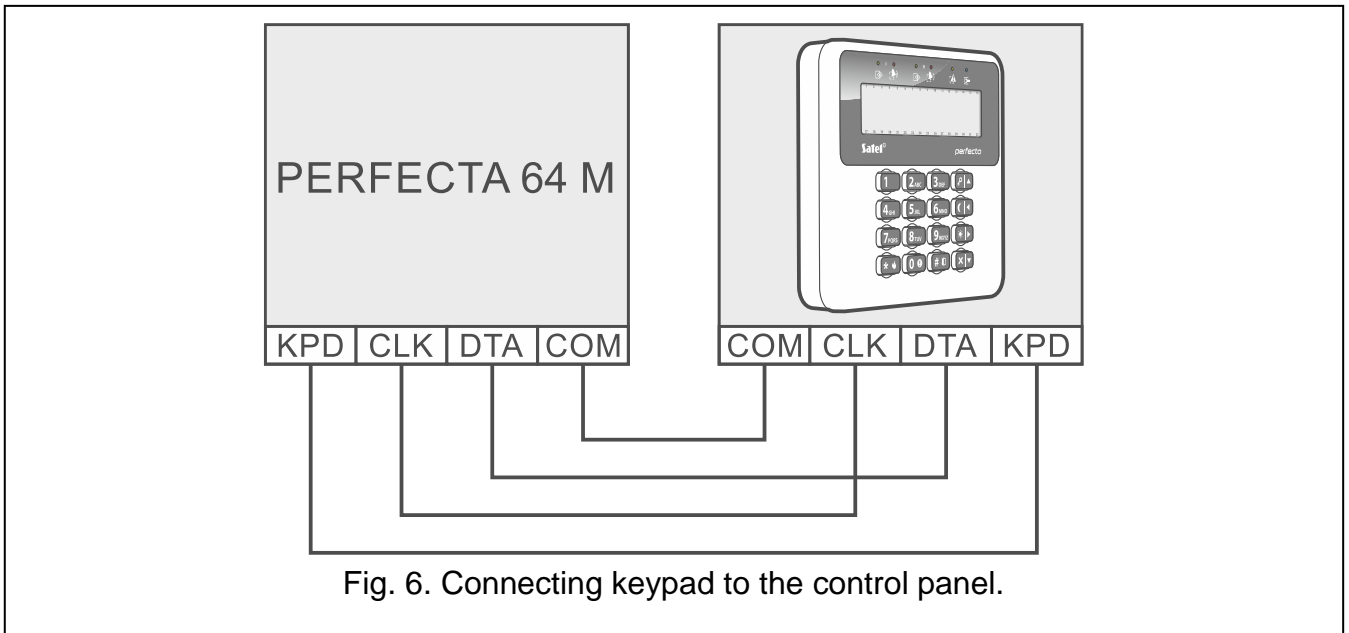

Fig. 5. Opening the keypad enclosure.

1. Open the keypad enclosure (Fig. 5).
2. Put the enclosure base on the wall and mark the location of mounting holes.
3. Drill the holes in the wall for wall plugs (screw anchors).
4. Run wires through the opening in the enclosure base.
5. Using wall plugs (anchors) and screws, secure the enclosure base to the wall. Select wall plugs specifically intended for the mounting surface (different for concrete or brick wall, different for plaster wall, etc.).
6. Screw the wires to the keypad terminals (Fig. 6).
7. Put the cover on the catches and snap the enclosure shut.
8. Lock the cover with screws.



6.6.2 Connecting the Ethernet communication module

If you connect the ETHM-1 Plus module to the control panel, Ethernet can be used to:

- report events,
- program the alarm system in the PERFECTA SOFT program,
- operate the alarm system in the PERFECTA CONTROL mobile app.

You can connect one ETHM-1 Plus module to the control panel. Set address 6 (06h) in the module.

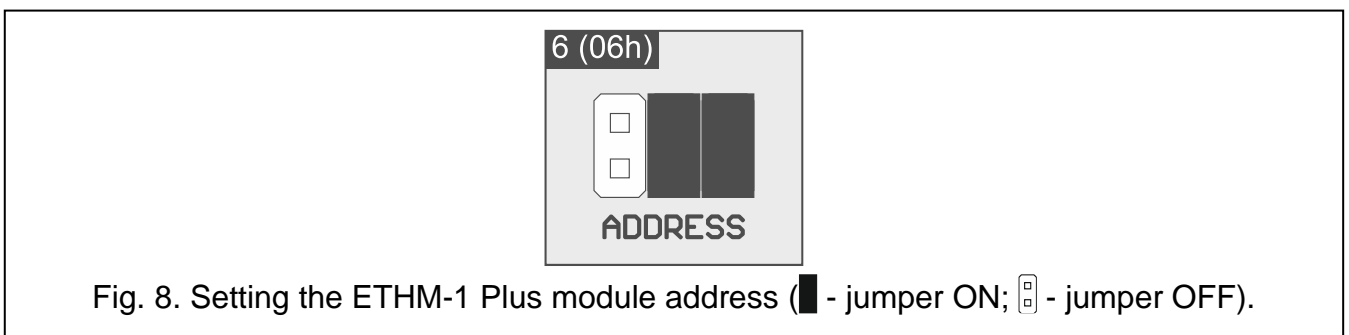
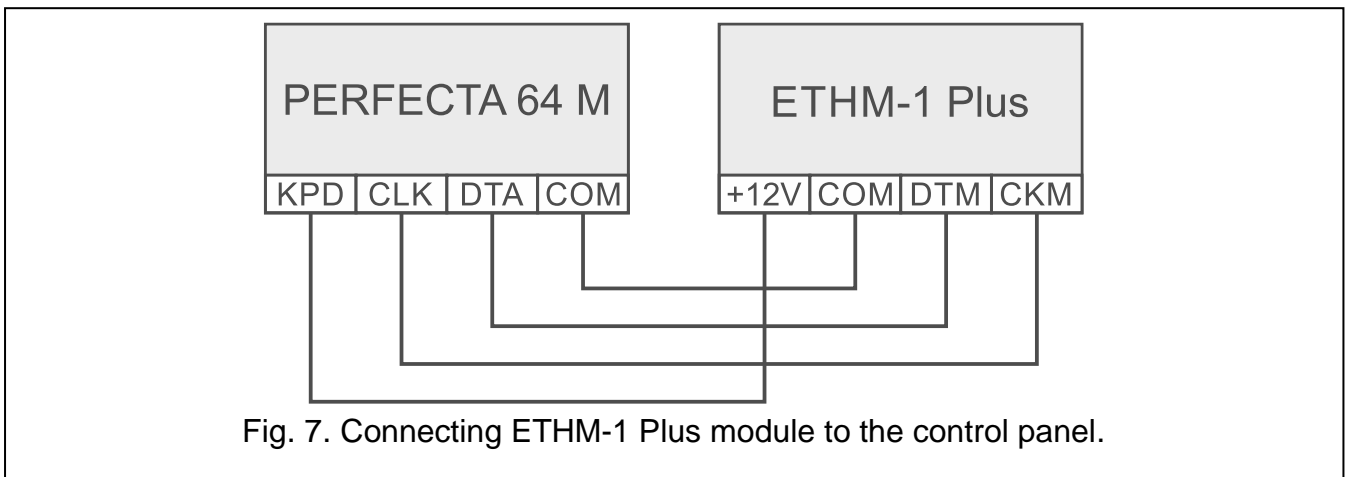

If the alarm system is to be programmed or operated via Ethernet, connect the control panel RS-232 (TTL) port to the module RS-232 port using the RS232-RSTTL converter.

6.6.3 Connecting the ABAX 2 wireless system controller



If the ACU-220 / ACU-280 controller is to be used, do not install the PERFECTA-RF module or the INT-RX-S expander. These devices cannot be used simultaneously.

If you connect the ABAX 2 controller (ACU-220 or ACU-280) to the control panel, you will be able to:

- install in the alarm system:
 - up to 4 PRF-LCD-A2 keypads,
 - up to 48 other ABAX 2 wireless devices (up to 48 wireless zones and outputs),
- assign ABAX 2 keyfobs to users (up to 62 keyfobs).

You can connect one ABAX 2 controller to the control panel.

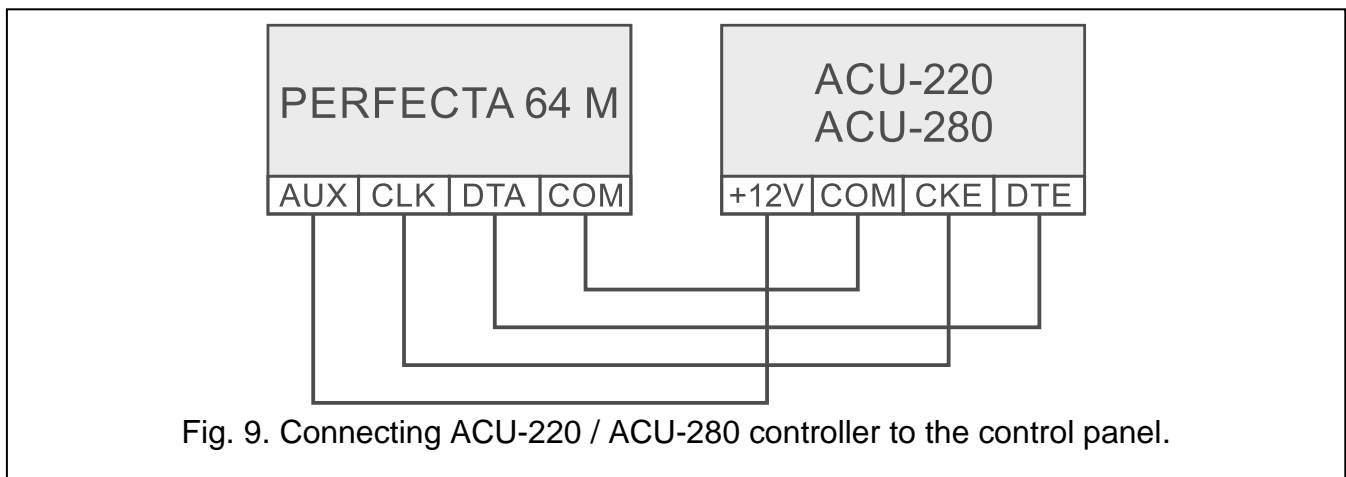

Fig. 9. Connecting ACU-220 / ACU-280 controller to the control panel.

Use the controller DIP-switches to select the correct operating mode:

- set switch 9 in OFF position,
- set switch 10 in ON position,
- you can set the remaining switches in any position (in the ACU-220 controller, switch 8 is used to select the transmitting antenna).

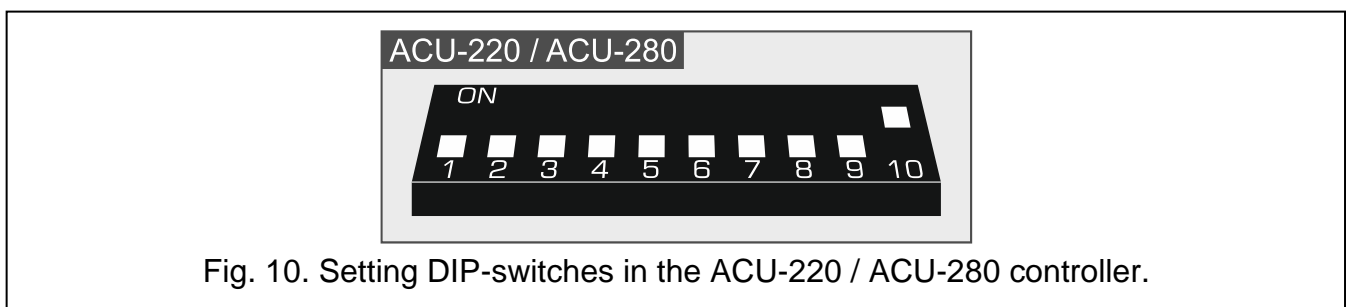

Fig. 10. Setting DIP-switches in the ACU-220 / ACU-280 controller.

After devices have been identified (see: p. 31), the controller receives address 8. After wireless devices have been registered to the controller, the controller can occupy the following addresses. The controller can occupy up to 6 addresses (see: "Registering the ABAX 2 devices to the controller" p. 33).



The addresses to be occupied by the ABAX 2 controller cannot be used by the hardwired zone expanders.

Data of the wireless keypads, wireless devices and keyfobs are stored in the controller. If you connect a controller with registered devices to the control panel:

- keypads will be added to the alarm system,

- wireless devices will be assigned to the alarm system zones / outputs,
- keyfobs will be assigned to users.

This may cause problems (e.g. identification may be impossible due to conflicting addresses). For this reason, it is recommended not to connect a controller with registered devices to the control panel.

6.6.4 Connecting 433 MHz keyfobs receiver expansion module



If the INT-RX-S expander is to be used, do not install the ACU-220 / ACU-280 controller or the PERFECTA-RF module. These devices cannot be used simultaneously.

If you connect the INT-RX-S expansion module to the control panel, the users will be able to control the alarm system using 433 MHz keyfobs. Each user may have their own keyfob (up to 62 keyfobs). You can connect one 433 MHz keyfobs receiver expansion module to the control panel. Set address 7 (07h) in the module.

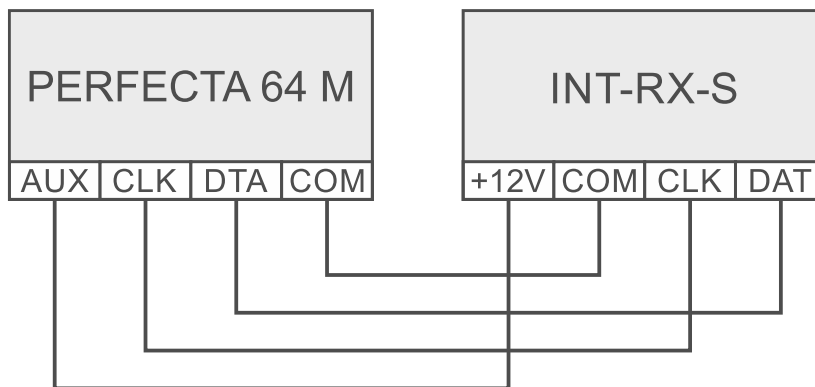

Fig. 11. Connecting the INT-RX-S expansion module to the control panel.

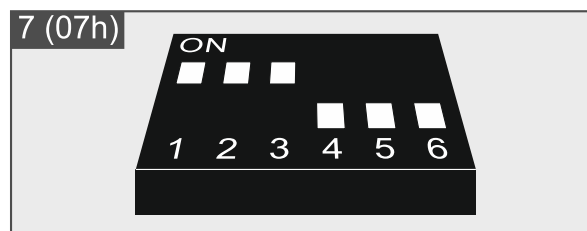

Fig. 12. Setting DIP-switches in the INT-RX-S expansion module.

6.6.5 Connecting the hardwired zone expanders

If you connect the INT-E expander to the control panel, you will increase the number of hardwired zones by 8. You can connect up to 7 zone expanders to the control panel.

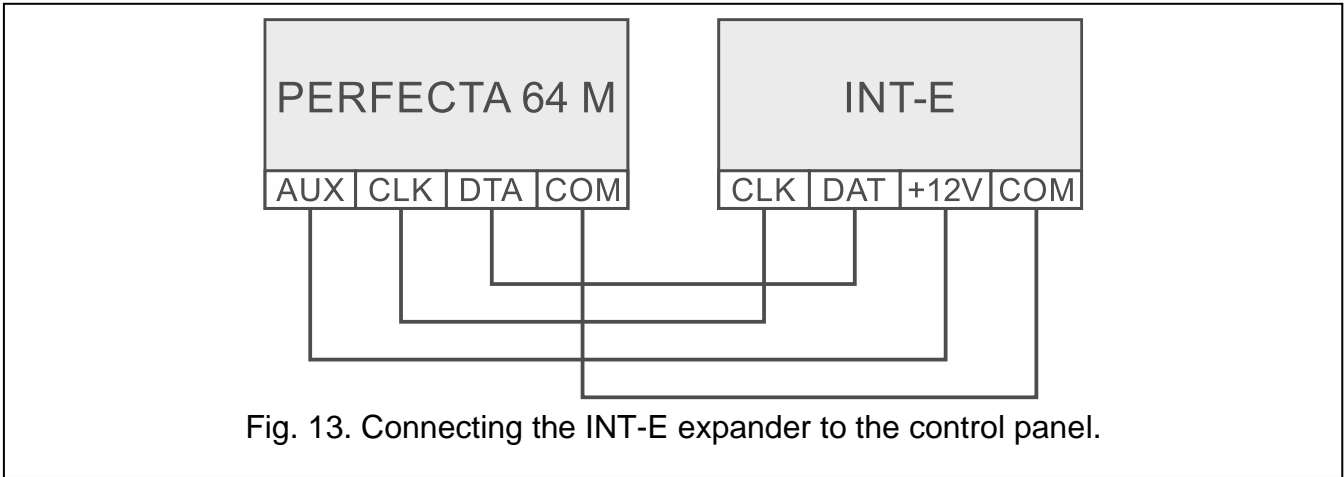

Fig. 13. Connecting the INT-E expander to the control panel.

In the expanders, set addresses in the range from 8 (8h) to 14 (0Eh).

i If the ABAX 2 controller is to be used in the alarm system, consider the number of addresses the controller will occupy after the wireless devices have been registered to the controller (see: “Registering the ABAX 2 devices to the controller” p. 33). Do not set an address in the expander that can be assigned to the ABAX 2 controller after the wireless devices have been registered.

The DIP-switch 10 must be set to the OFF position.

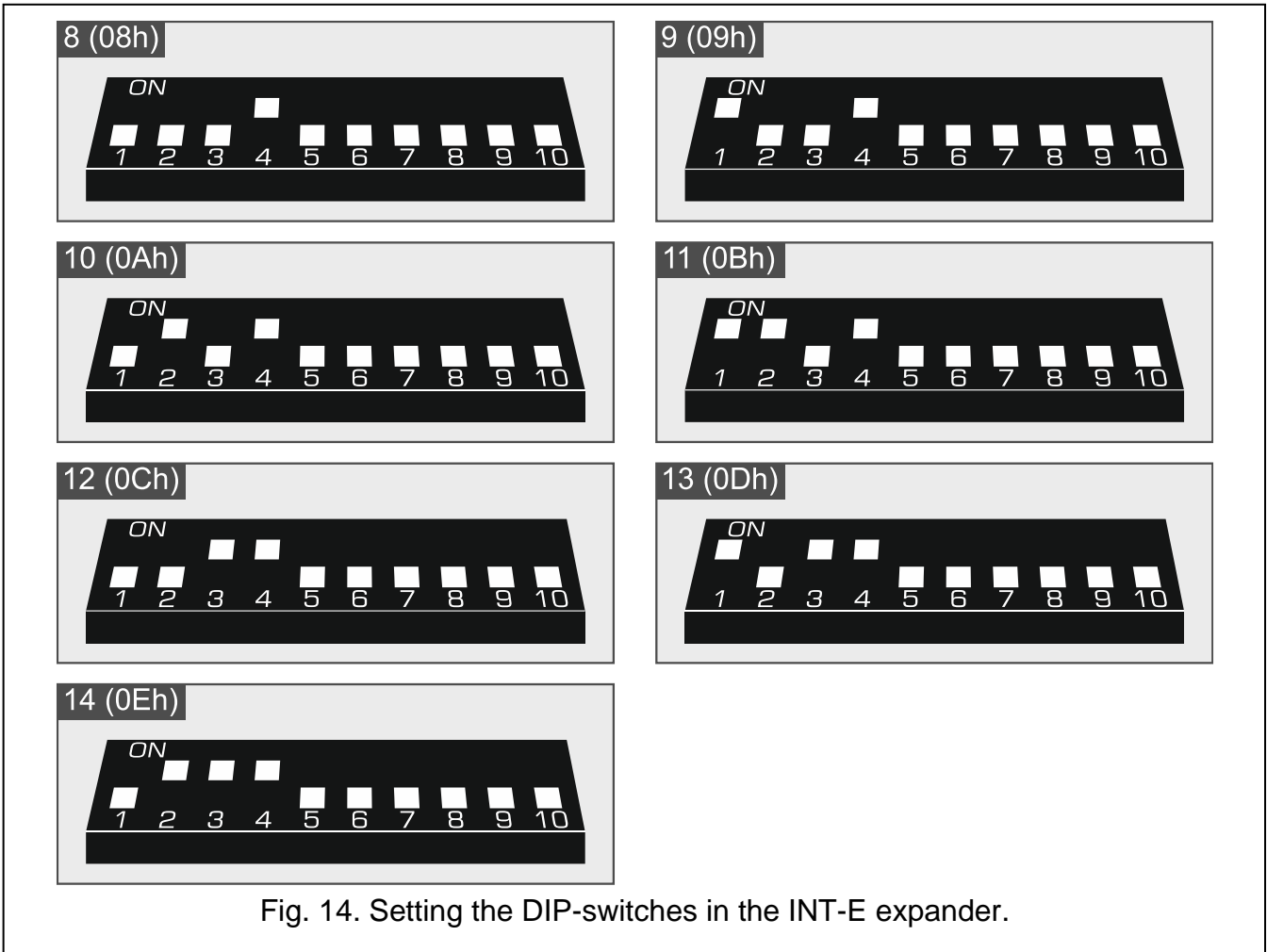

Fig. 14. Setting the DIP-switches in the INT-E expander.

If a number of expander zone coincides with a number of MICRA wireless zone, the expander zone will not be supported.

The zone expanders and the ABAX 2 controller cannot occupy the same addresses. For this reason, the expander zone numbers and the ABAX 2 wireless zone numbers do not coincide.

Expander address		Zone numbers
decimal	hexadecimal	
8	08	9-16
9	09	17-24
10	0A	25-32
11	0B	33-40
12	0C	41-48
13	0D	49-56
14	0E	57-64

Table 2. Numbering of the expander zones depending on the address set.

The INT-E expander will be identified as:

INT-E – power supply by SATEL is not connected to the expander connector,

INT-EPS – power supply by SATEL is connected to the expander connector.

6.6.6 Connecting the hardwired output expanders

If you connect the INT-O / INT-ORS expander to the control panel, you will increase the number of hardwired outputs by 8. You can connect up to 7 output expanders to the control panel.

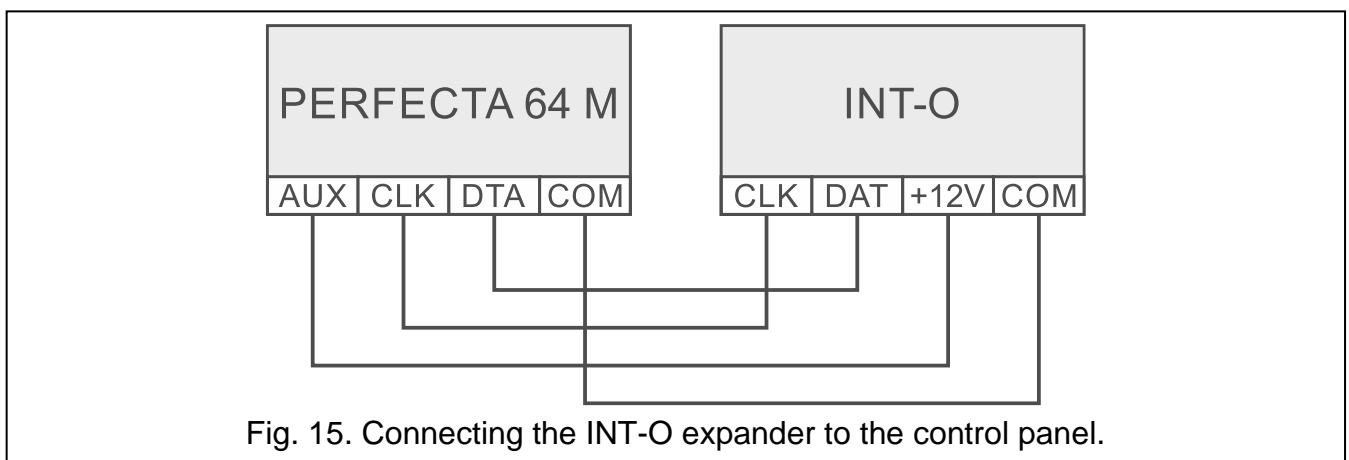

Fig. 15. Connecting the INT-O expander to the control panel.

In the expanders, set addresses in the range from 15 (0Fh) to 21 (15h). Additionally, in the INT-ORS expanders:

10-position DIP-switch: set switch 6 in OFF position and switch 10 in ON position,

6-position DIP-switch: set switch 6 in OFF position.

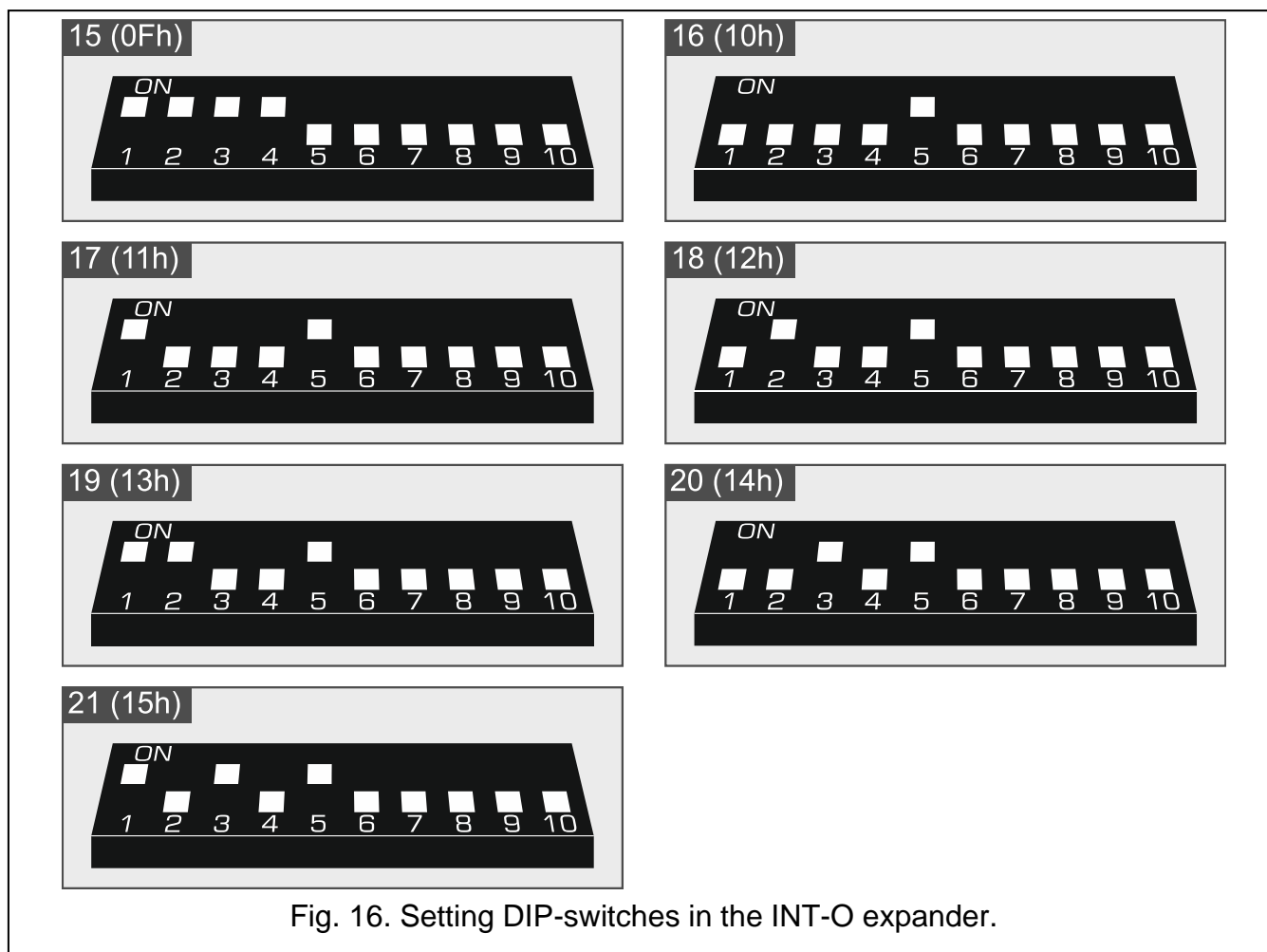

Fig. 16. Setting DIP-switches in the INT-O expander.

Expander address		Output numbers
decimal	hexadecimal	
15	0F	5-12
16	10	17-24
17	11	25-32
18	12	33-40
19	13	41-48
20	14	49-56
21	15	57-64

Table 3. Numbering of the expander outputs depending on the address set.

The INT-O / INT-ORS expander will be identified as:

INT-O – power supply by SATEL is not connected to the expander connector,

INT-OPS – power supply by SATEL is connected to the expander connector.

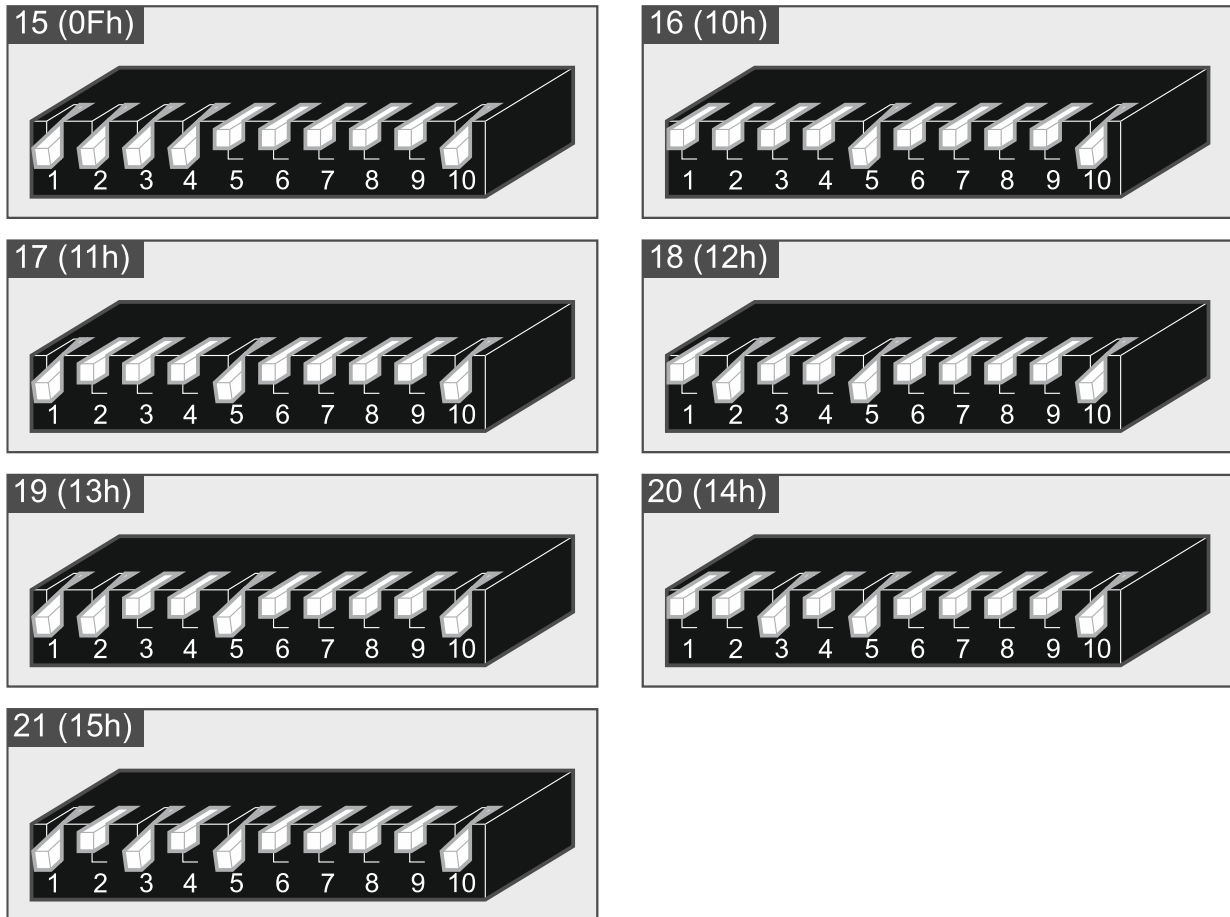

Fig. 17. Setting DIP-switches in the INT-ORS expander.

6.6.7 Connecting the proximity card arm/disarm devices

If you connect the INT-CR / INT-IT-2 device to the control panel, the alarm system users will be able to arm / disarm partitions and clear alarms using the proximity cards / tags. You can connect up to 8 proximity card arm/disarm devices to the control panel. In the devices, set addresses in the range from 22 (16h) to 29 (1Dh).

The INT-CR device will be identified as INT-IT-2.

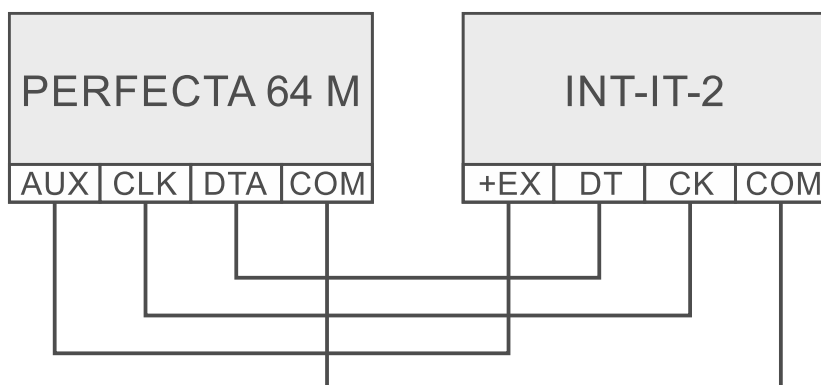

Fig. 18. Connecting the INT-IT-2 device to the control panel.





INT-CR wire	Description	Control panel terminal
 brown	power	AUX / KPD
 white	common ground	COM
 gray	clock	CLK
 green	data	DTA

Table 4. Connecting the INT-CR device to the control panel.

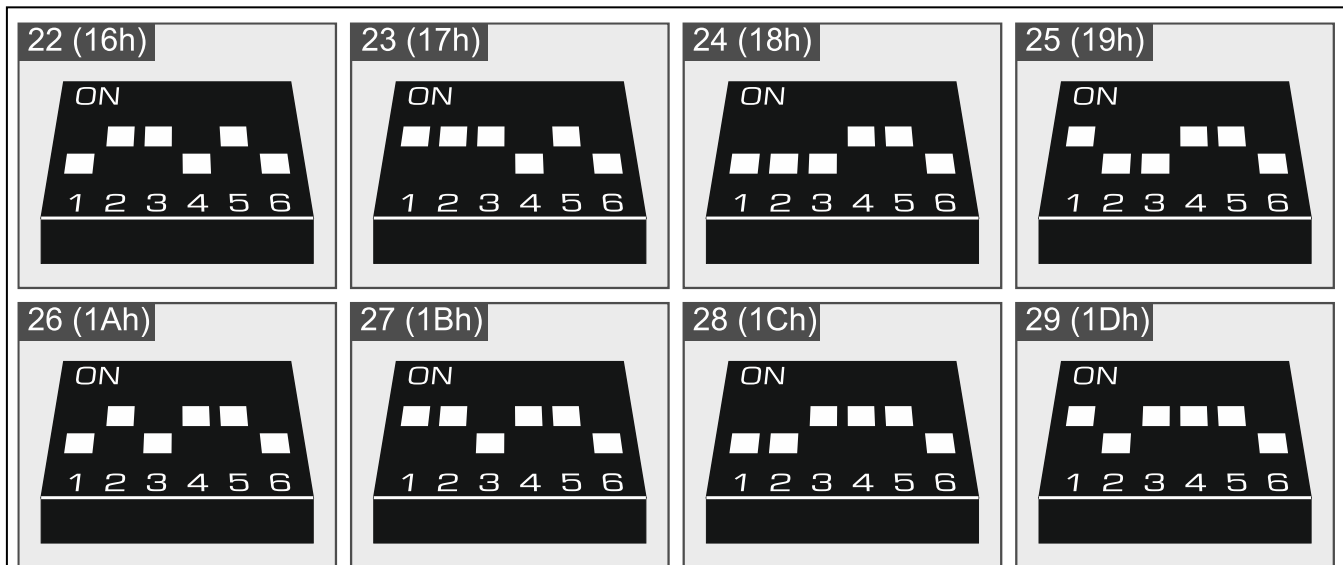

Fig. 19. Setting DIP-switches in the INT-IT-2 expander.

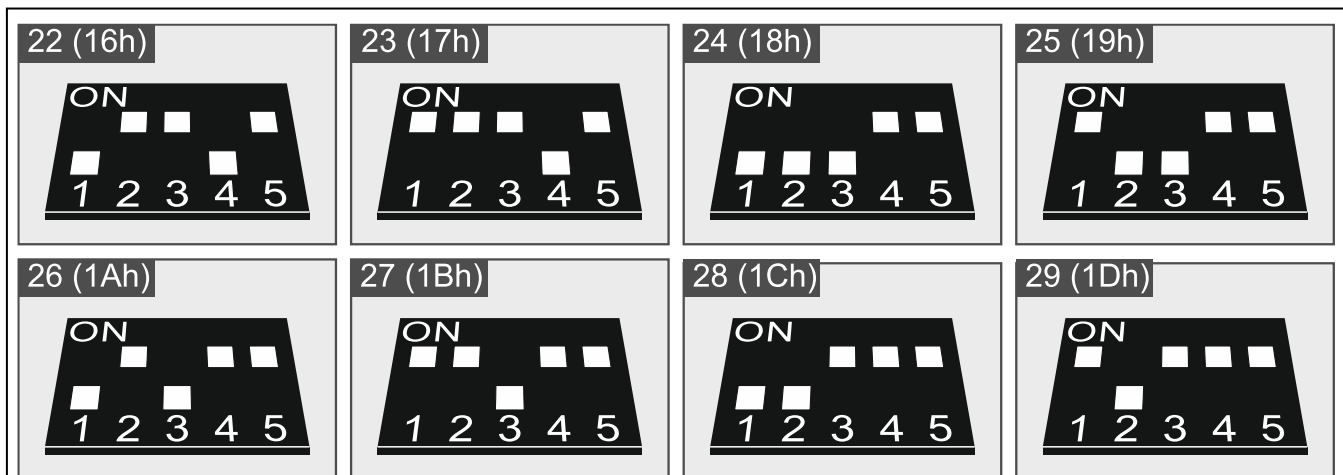
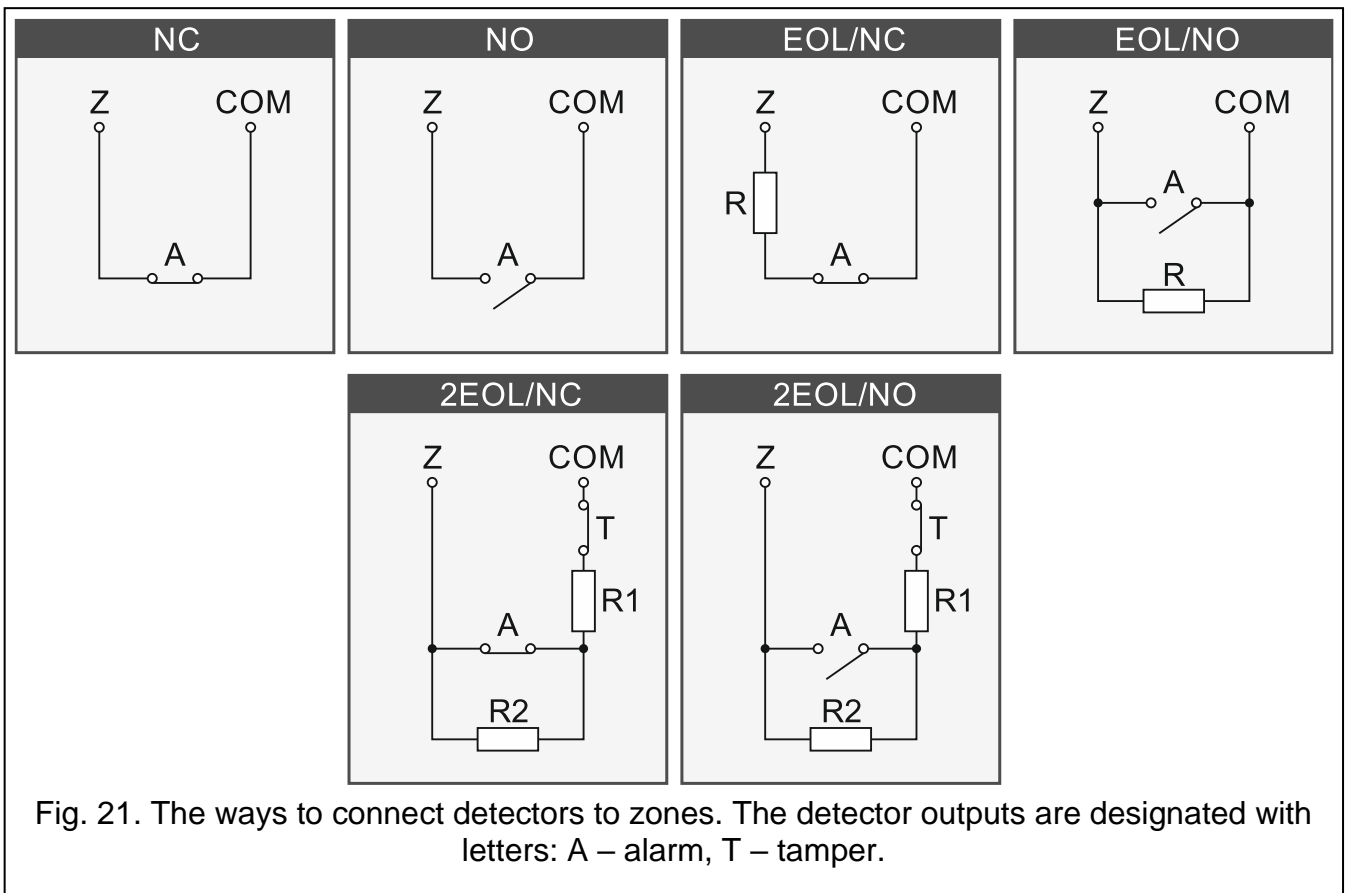

Fig. 20. Setting DIP-switches in the INT-CR expander.

6.7 Connecting detectors and other devices to the zones



Zones of the control panel support the following wiring configurations:

NC – for connecting a detector with NC (normally closed) alarm output. Opening the circuit will trigger an alarm.

NO – for connecting a detector with NO (normally open) alarm output. Closing the circuit will trigger an alarm.

EOL – for connecting a detector with NC or NO alarm output. An EOL resistor must be used in the circuit. Alarm will be triggered by closing or opening the circuit.

2EOL/NC – for connecting a detector with NC alarm output and tamper output. Two EOL resistors must be used in the circuit. The zone can distinguish between 3 states: normal, alarm and tamper.

2EOL/NO – wiring configuration similar as 2EOL/NC, but for detectors with the NO alarm output.

Shutter – for connecting a roller shutter detector.

Vibration – for connecting a shock detector. You can also connect to the zone a detector with NC alarm output (e.g. shock detector and magnetic contact can be connected in series).

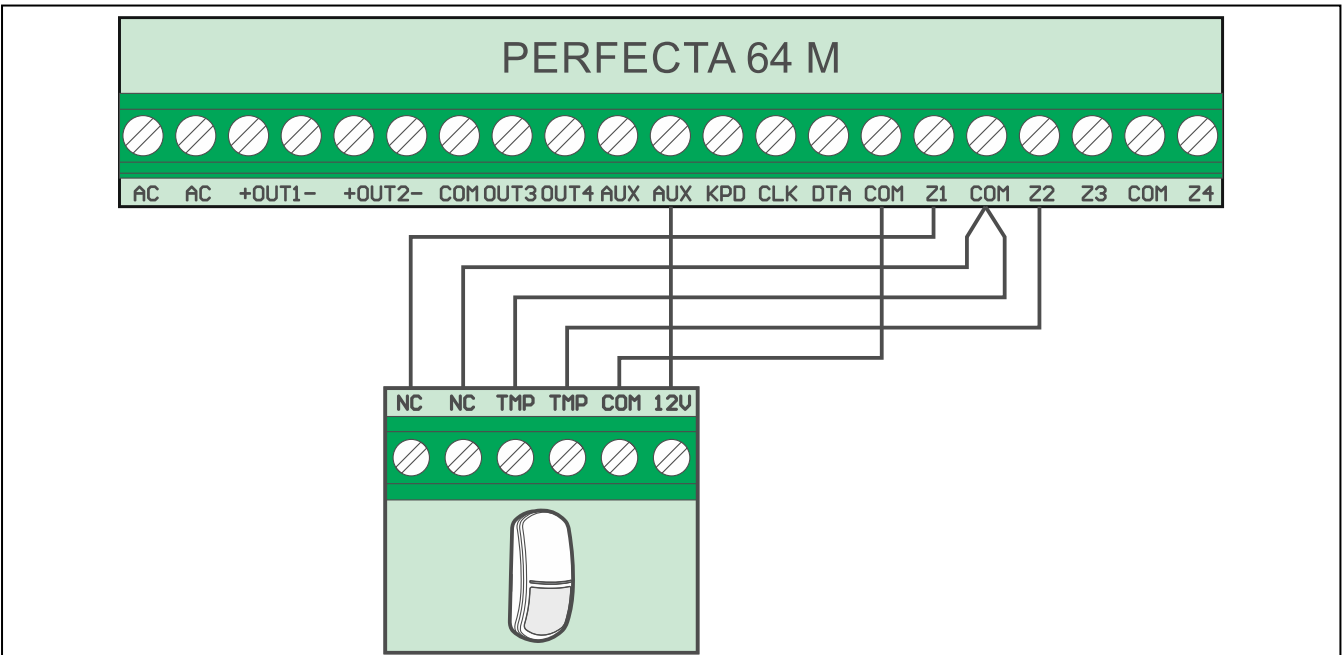

Fig. 22. Example of connecting an NC detector (NO detector connect in the same way).

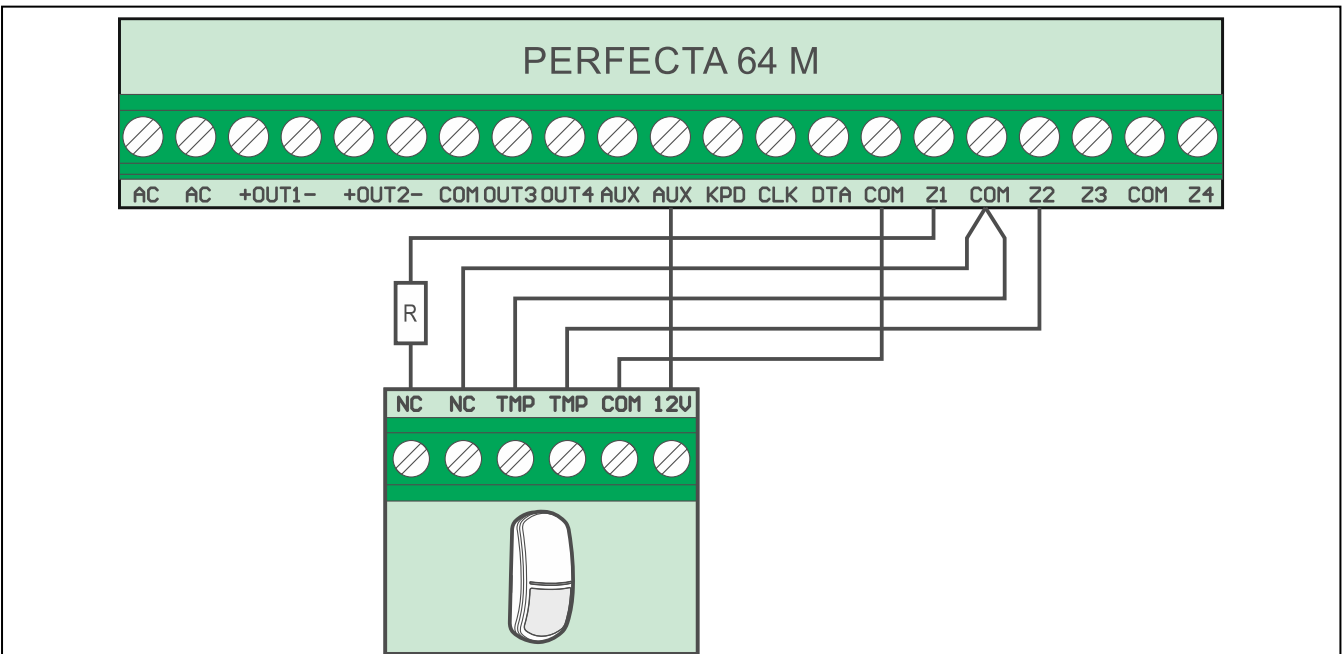

Fig. 23. Example of connecting an NC detector in Single EOL configuration.

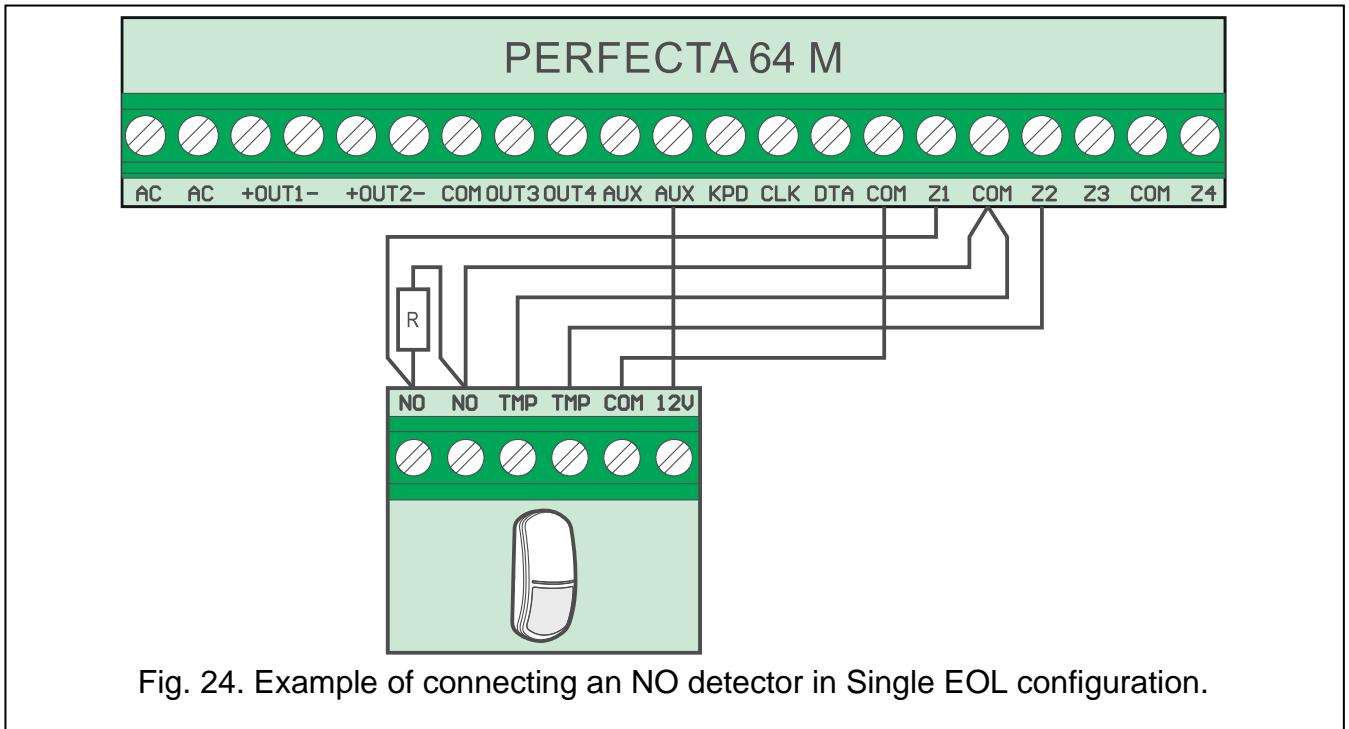

Fig. 24. Example of connecting an NO detector in Single EOL configuration.

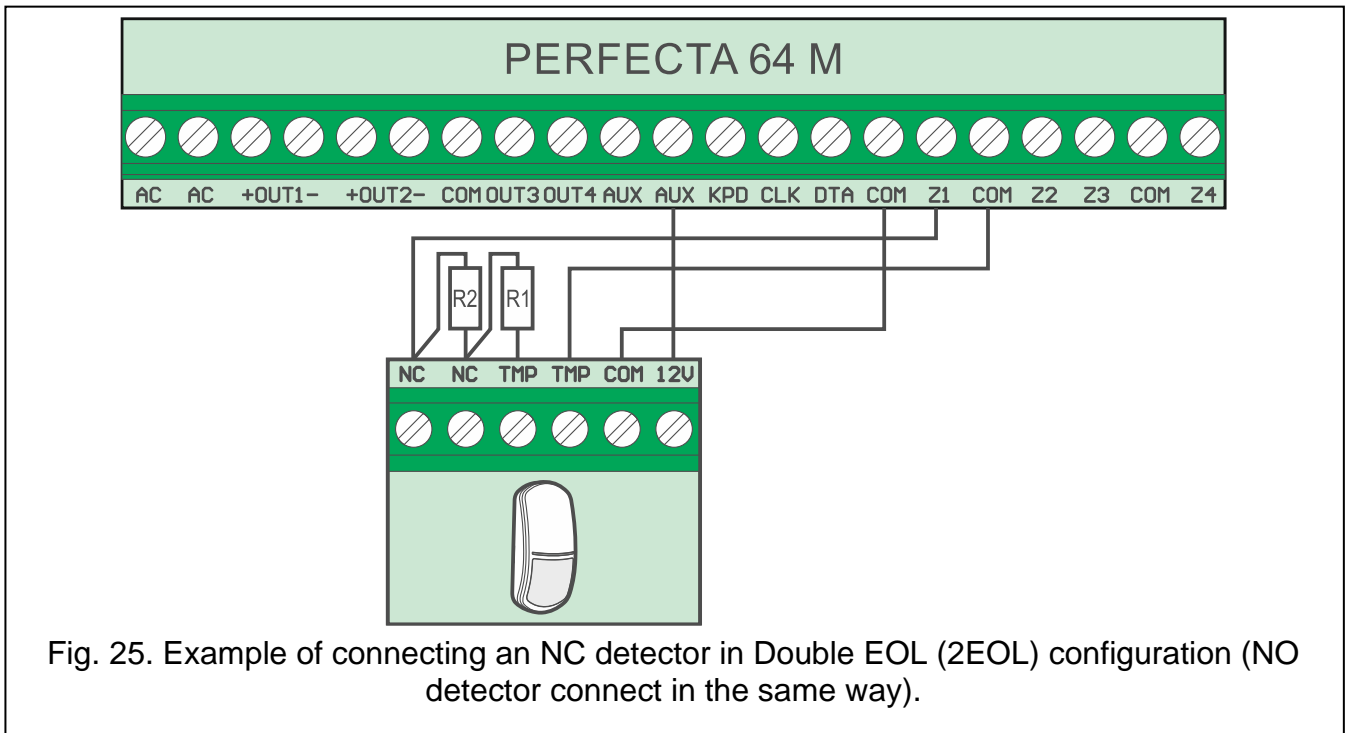

Fig. 25. Example of connecting an NC detector in Double EOL (2EOL) configuration (NO detector connect in the same way).

End-of-line resistors

The value of EOL resistors is programmable within the range from 500 Ω to 14,5 kΩ. The sum of preset values for resistors R1 and R2 cannot exceed 15 kΩ.

According to the factory settings, depending on the wiring type:

- EOL – use one 2.2 kΩ resistor,
- 2EOL – use two 1.1 kΩ resistors

For details on how to program the value of EOL resistors, please refer to the *Programming manual*.

6.8 Connecting the sirens



It is recommended that the control panel be started without connected sirens. This will prevent accidental triggering of the alarm after the control panel is started.

Depending on the siren type:

- sirens without own power source (e.g. SP-500, SP-4001, SP-4003, SPL-2010, SPW-100, SPW-210, SPW-220) – high-current outputs are to be used to trigger the signaling,
- sirens with own power source (e.g. SP-4002, SP-4004, SP-4006, SP-6500, SPLZ-1011, SD-3001, SD-6000) – it is recommended to use low-current outputs to trigger the signaling, and high-current ones – to supply power.

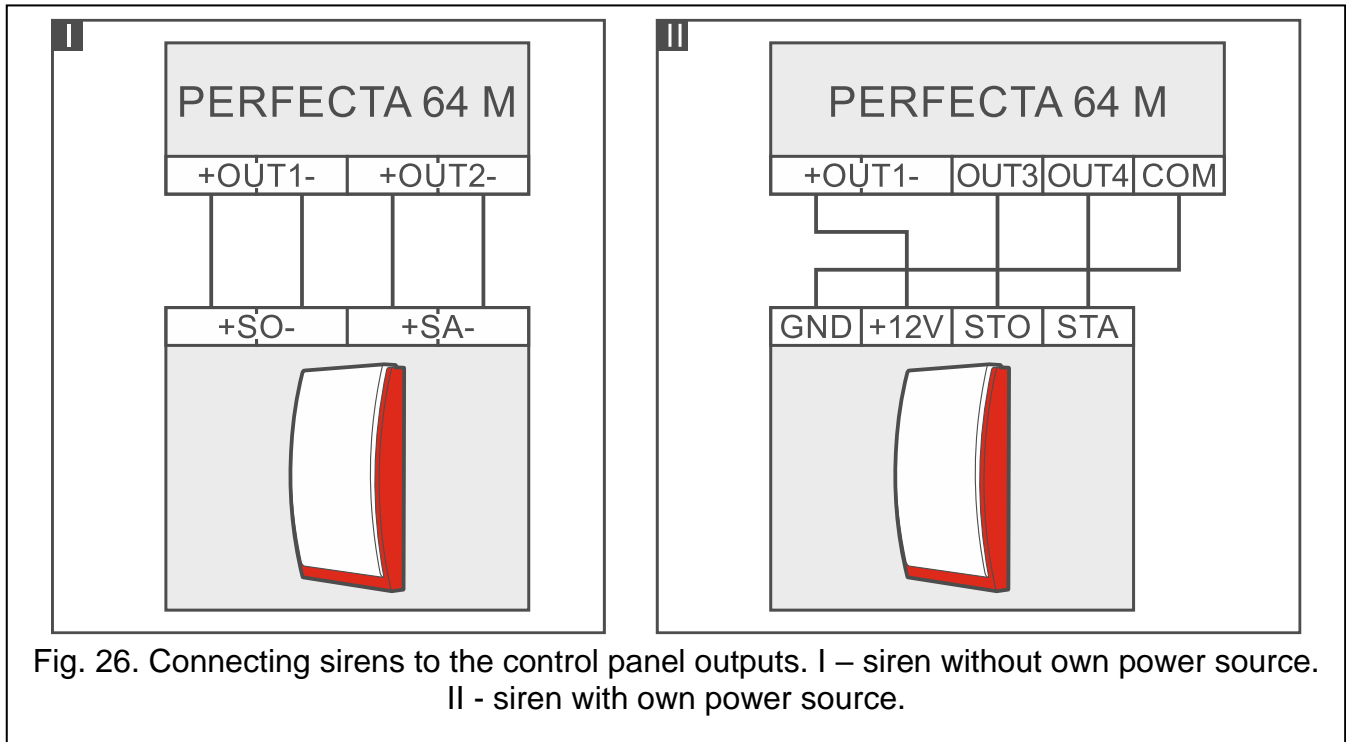

Fig. 26. Connecting sirens to the control panel outputs. I – siren without own power source. II - siren with own power source.

6.9 Connecting the microphone

The microphone will allow the users to listen in to the sounds from the protected premises after establishing telephone connection with the control panel. SATEL offers the MIC-1 microphone, which can be connected to the mini-jack socket on the control panel. If you decide to use another type, it should be an electret microphone, e.g. a typical computer microphone.

When selecting the microphone installation place, bear in mind that curtains, drapes, upholstery, acoustic tiles, etc. absorb sound and, as a result, make it difficult, if not impossible, to use the listen-in feature. It is not advisable to install the terminal in the vicinity of equipment which generates noise during operation (e.g. fans, air conditioners, refrigerators).

6.10 Connecting the power and starting the control panel



Do not connect power until all installation operations are completed.

6.10.1 Main power source

The control panel requires 18 VAC ($\pm 10\%$) power. It is recommended that a transformer with 40 VA rating be used.

The transformer should be permanently connected to the 230 VAC mains power. The electrical circuit to which the transformer is to be connected must have suitable protection (2-pole switch disconnecter and/or 16 A slow-blow fuse). Instruct the owner / user of the system on how to disconnect the transformer from the mains supply (e.g. indicate the fuse or circuit breaker protecting the transformer supply circuit).



Do not connect two devices with power supply to one-section transformer.

Before connecting transformer to a circuit from which it will be powered, make sure the circuit is de-energized.

6.10.2 Backup power source

For a backup power source, use a 12 V sealed lead-acid battery or other 12 V battery with similar charging characteristics. The battery capacity must be selected to match current consumption in the system. According to EN 50131 Grade 2, the battery must ensure operation of the system without mains power for 12 hours.

If the battery voltage drops below 11 V for longer than 12 minutes (3 battery tests), the control panel will indicate battery failure. When the voltage goes down to approx. 10.5 V, the battery will be disconnected.



Do not connect deeply discharged battery to the control panel (with voltage across unloaded terminals below 11 V). The battery should be precharged with a proper charger.

The used batteries must not be discarded, but should be disposed of in accordance with the existing rules for environment protection.

6.10.3 Control panel power-up / start-up procedure

1. De-energize the 230 VAC circuit to which the transformer is to be connected.
2. Connect the 230 VAC wires to the terminals of transformer primary winding.
3. Connect the terminals of transformer secondary winding to the control panel AC terminals. To make the connection, use flexible wires with a cross-section of 0.5-0.75 mm².
4. Connect the battery wires (Fig. 3) to the connector on the electronics board.
5. Connect the battery to the dedicated wires (positive terminal to RED wire, negative terminal to BLACK wire). If the battery has screw-type cable lugs, use adapters delivered with the control panel (do not cut off the battery cable lugs). **The control panel will not start after connecting the battery alone.**
6. Turn on 230 VAC power in the circuit to which the transformer is connected. The control panel will start operating.



The above mentioned power-up sequence (first the battery, then the 230 VAC mains) will ensure proper operation of the power supply and the electronic protection circuits, thus preventing damage to the alarm system components caused by installation mistakes, if any.

If it is necessary to de-energize the control panel, turn off the main power (AC) first, and the backup power (battery) afterwards. Observe the above described procedure when reconnecting the power.

6.10.4 Starting the service mode

If, after starting the alarm control panel, you want to perform any operations that not require power-off (e.g. to adjust sensitivity in wired detectors), enter the service mode.



When the control panel is running in service mode, tamper alarms are not generated.

1. Enter the **service code** (by default: 12345) and press *** 🔥**. User menu will be displayed.
2. Press **🔑 ▲**.
3. When the **➔** cursor shows the SERVICE MODE function, press **# 🔒**. Service menu will be displayed (the **➔** cursor will show the END SM function).

6.10.5 Emergency procedure of the control panel start-up

If the control panel fails to start properly, keypads are not supported, codes are not accepted by the control panel etc., despite all connections having been made correctly, follow the steps below:

1. Power off the control panel (first disconnect the AC power, and then the battery).
2. Put a jumper on the RESET pins.
3. Power on the control panel (first connect the battery and then the AC power).
4. Wait a few seconds (until LEDs next to the RESET pins stop blinking) and remove the jumper from the RESET pins. The control panel will enter the service mode. The service mode menu will be displayed on the wired keypad with the lowest address.



If there is no wired keypad in the alarm system or there is no communication with the wired keypads (e.g. when the communication bus is shorted), you can get access to the service mode menu from the wireless keypad with the lowest address. Press any key on this keypad within 30 seconds of removing jumper from the RESET pins.

*The service mode menu will not be displayed, if the Disable service mode option is enabled in the control panel. The "Factory settings ? 1=Yes" message will be displayed on the keypad with the lowest address. You can press **1** to restore the factory default settings. The service mode menu will not be displayed until the factory settings are restored.*

6.10.6 First steps after starting-up the control panel

Control panel with wired keypads

If wired keypads are connected to the control panel, then, after starting the control panel with factory settings:

1. Set correct, individual addresses in the wired keypads.
2. Run the function of identification of devices.

Control panel without wired keypads

If no wired keypads are connected to the control panel, then, after starting the control panel with factory settings:

1. Connect computer to alarm control panel.
2. Use the PERFECTA SOFT program to add wireless keypads.
3. Run the function of identification of devices.

6.11 Programming addresses for the hardwired keypads

An individual address from the 0 to 3 range must be set for each keypad. By default, address 0 is preset for all wired keypads. After starting the alarm control panel with factory default settings, all keypads connected to the bus are supported, no matter what their addresses are. This allows you to program individual address for the keypads.



Remember to program an individual address if a new keypad is connected to the already functioning alarm system.

Below, it is described how to program the address in the PRF-LCD keypads. The instructions for other wired keypads are described in their respective manuals.

6.11.1 Programming the address by means of the service function



The address programming function can be started from either a wired or wireless keypad, but it will only allow setting addresses in the wired keypads.

1. Start the service mode (see: “Starting the service mode” p. 29).
2. Press successively **2_{ABC}** **0** **#** to run the 20.KPD.ADDRESS function. The following message will be displayed on all wired keypads: “This LCD address (n, 0-3)” [n – keypad address; 0-3 – range of supported addresses] (Fig. 27).

The image shows a rectangular LCD display with a black background and white text. The text is arranged in two lines. The first line reads "This LCD address" and the second line reads "(n: 0-3): _". The text is in a simple, pixelated font.

Fig. 27. Programming keypad address (n = current address).

3. On the keypad the address of which you want to change, press the key whose digit corresponds to the new address, then press ***_☛**. The keypad will be restarted. Service menu will be displayed.



If you fail to set the new address within 2 minutes after you started the 20.KPD.ADDRESS function, the function will be terminated automatically and the keypad will be restarted.

6.11.2 Programming the address without entering the service mode

This way of address programming is useful when the keypad operation is blocked and starting the service mode is impossible.

1. Power off the keypad.
2. Disconnect wires from the keypad CLK and DTA terminals.
3. Short the CLK and DTA keypad terminals.
4. Power on the keypad.
5. Information on the current address and permissible address range will be displayed on the keypad (Fig. 27).
6. Press the key whose digit corresponds to the new address (if you make a mistake, press ***_☛** to restart the keypad – current address information will be displayed again).
7. Power off the keypad.
8. Open the CLK and DTA keypad terminals.
9. Connect wires properly to the CLK and DTA keypad terminals.
10. Power on the keypad.

6.12 Identifying devices

Devices connected to the communication bus and the communication connector (PERFECTA-RF) will not be properly supported, unless they have been identified by the control panel. Identification of the devices is required after:

- the control panel is started for the first time,

- new device is added to the communication bus,
- address is changed in a device connected to the communication bus,
- device is disconnected from the communication bus,
- PERFECTA-RF module is installed,
- PERFECTA-RF module is uninstalled,
- ABAX 2 wireless device is added or removed.



Disconnecting an identified device will trigger the tamper alarm.

6.12.1 Identifying devices by means of the keypad

1. Start the service mode (see: “Starting the service mode” p. 29).
2. Press successively **2_{ABC}** **1** **# 0** to run the 21.IDENTIFICAT. function. “Please wait...” message will be displayed.
3. When identification is complete, the total number of devices connected to the communication bus and the communication connector will be displayed.



If information is displayed that there is a problem with a device with specific address, it means that a wrong address is set on the device (invalid for this type of device or the same address is set on at least two devices) or that the device is not supported.

4. Press *** 0** to return to menu.

6.12.2 Identifying devices by means of the PERFECTA SOFT program

1. Click on the “Hardware” tab.
2. Click on “Mainboard”.
3. Click on “Detect connected modules”.
4. When identification is complete, a window with the total number of devices connected to the communication bus and the communication connector will be displayed.



In the event of any problems with identification (e.g. an invalid address is set in the device), a message will be displayed to inform you about the problem.

5. Click on “READ DATA FROM PANEL”.

6.13 Installing the SIM card

Slots on the mainboard make it possible to install two nano-SIM cards.



If the control panel is to transmit data over the cellular network, it is recommended that you use SIM cards with a dedicated tariff plan for M2M (machine-to-machine) communication.

If the SIM card requires entering the PIN code, program the PIN code before you install the card.

If you enter a wrong PIN code, a trouble will be reported after using it. After 255 seconds the control panel will retry to use the PIN code. After the third attempt to use a wrong PIN code, the SIM card will be blocked. To unblock the card, enter the PUK code using the keypad (see: User manual).

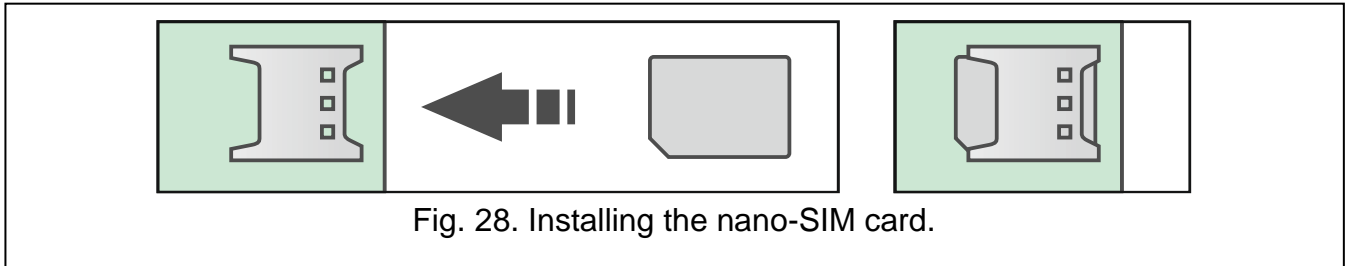

Fig. 28. Installing the nano-SIM card.

6.14 Connecting the computer to the control panel

You can connect the control panel RS-232 (TTL) port with the USB port on a computer. To make the connection, use the USB-RS converter offered by SATEL. Having connected the computer to the control panel, you can:

- configure the alarm system in the PERFECTA SOFT program (communication is encrypted),
- update the control panel firmware.

6.15 Installing the ABAX 2 wireless devices

If you connected the ABAX 2 controller (ACU-220 / ACU-280) to the control panel, you can install ABAX 2 wireless devices in the alarm system. You can do it after starting the control panel and identifying the devices used in conjunction with the control panel.

Before installing a wireless device, check the level of radio signal received by the device from the controller and by the controller from the device at the planned installation place. You can check the radio signal level using the ARF-200 tester. It allows you to check the radio signal strength at the place of future installation without having to put the device there. The level of signal received by the device/controller may not be lower than 40%. If the radio signal level at the planned installation place is lower, select another installation place. It may be sufficient to shift the device ten or twenty centimeters. You can only install the device at the planned location after making sure that the level of the radio signal is correct. For detailed information about installation of individual devices, please refer to the manuals of the respective products.

6.15.1 Registering the ABAX 2 devices to the controller

The ABAX 2 wireless devices must be registered to the controller (only the ARF-200 tester can be supported when unregistered). You can do it in the PERFECTA SOFT program.



Before adding a device that was previously registered to the ABAX / ABAX 2 system, you must restart it (remove the battery / power the device off for 30 seconds).

When registering a device, you must enter its serial number. The serial number sticker is on the device (location of the sticker is indicated in the manual of the device). The serial number of each ARF-200 tester is 0000500.

The controller supports:

- up to 4 wireless keypads,
- up to 48 detectors, sirens or other wireless devices.

When registered, some devices will occupy two or more positions on the list. Therefore, the actual number of devices that can be registered depends on how many positions will be taken up by individual devices. For example, the expander ACX-220 can take up 4 positions. After registering it to the controller, the pool of positions for further devices will decrease by 4 (e.g. if there were 48 positions available before registering the expander, 44 positions will remain after registering the expander, i.e. you will still be able to register up to 44 devices).

These rules do not apply to the keypads because a separate pool of positions is allotted to them.



For many devices that occupy two or more positions on the device list, you can select how many positions are to be occupied. You can do it during the registration process.

Data of the wireless devices are stored in the controller. If you connect to the control panel a controller with registered devices, the devices will be added to the system.

Each position on the device list represents one wireless zone or one wireless zone and one output.

When adding and removing the wireless devices, remember that the identification function registers zones and outputs by groups of 8. Already after adding one wireless device which takes up 1 zone, the control panel will reserve 8 zones in the system for wireless devices. Observe continuity, i.e. avoid leaving any gaps in the list, which will later reduce the number of available zones in the system. Remember to preserve continuity also when removing wireless devices. For example, if the devices registered in the controller occupy 9 positions on the list, then 16 zones (2x8) are reserved in the system. After removal of the device which occupied position 7 on the list, there will still be 16 zones (2x8) reserved in the system for wireless devices, although 8 positions are actually taken up on the list of wireless devices (see: Table 5). In such a case, it is recommended that the last devices be removed from the list and then added to the system again, so as to fill up the gap in the list and reduce the number of zones reserved for wireless devices.

In case of devices which, in addition to zones, also take up outputs, it is recommended that you add them to the system first. This will allow you to maintain the continuity of use of not the zones alone, but the outputs as well.

In some cases, the gaps in the list of zones/outputs cannot be avoided. It applies to situation when the number of zones/outputs, which is used by the devices, is not a multiple of 8.

For each group of 8 zones/outputs, one address on the expander bus is reserved. The controller can occupy from 1 to 6 addresses (addresses from 8 (8h) to 13 (0Dh)). Remember about this at the system design stage. Leave a sufficient number of free addresses for the controller. Otherwise, it will be impossible to successfully identify devices. This will happen when the next addresses needed by the controller after new wireless devices have been added to the system are occupied by zone expanders. Then, it will be necessary to change addresses of the zone expanders.

Table 5 shows the example of wireless devices registered incorrectly. The first siren output occupies position 8, and the second output occupies position 9. As a result, 16 outputs have been reserved for wireless devices in the system, although actually only 2 are used (the eighth output in the first group of 8 outputs and the first output in the second group of 8 outputs). For devices taking up 8 positions, the system must reserve 16 zones and 16 outputs as well as 2 addresses. Table 6 shows the same devices registered correctly. For 8 devices, the system has reserved 8 zones and 8 outputs as well as 1 address.

ACU-220 / ACU-280		PERFECTA 64 M				
It.	list of devices	zones		outputs		
		No	device	No	device	
1	APD-200 detector	8	9	APD-200 detector	5	unused/unavailable
2	APD-200 detector		10	APD-200 detector	6	unused/unavailable
3	AMD-200 detector		11	AMD-200 detector	7	unused/unavailable
4	AMD-200 detector		12	AMD-200 detector	8	unused/unavailable
5	AMD-201 detector		13	AMD-201 detector	9	unused/unavailable
6	^		14	AMD-201 detector	10	unused/unavailable
7			15	unused/unavailable	11	unused/unavailable
8	ASP-200 siren		16	ASP-200 siren	12	ASP-200 siren
9	^	8	17	ASP-200 siren	17	ASP-200 siren
10			18	unused/unavailable	18	unused/unavailable
11			19	unused/unavailable	19	unused/unavailable
12			20	unused/unavailable	20	unused/unavailable
13			21	unused/unavailable	21	unused/unavailable
14			22	unused/unavailable	22	unused/unavailable
15			23	unused/unavailable	23	unused/unavailable
16			24	unused/unavailable	24	unused/unavailable



Table 5. Example of ABAX 2 devices registered incorrectly.

ACU-220 / ACU-280		PERFECTA 64 M				
It.	list of devices	zones		outputs		
		No	device	No	device	
1	ASP-200 siren	8	9	ASP-200 siren	5	ASP-200 siren
2	^		10	ASP-200 siren	6	ASP-200 siren
3	APD-200 detector		11	APD-200 detector	7	unused/unavailable
4	APD-200 detector		12	APD-200 detector	8	unused/unavailable
5	AMD-200 detector		13	AMD-200 detector	9	unused/unavailable
6	AMD-200 detector		14	AMD-200 detector	10	unused/unavailable
7	AMD-201 detector		15	AMD-201 detector	11	unused/unavailable
8	^		16	AMD-201 detector	12	unused/unavailable

Table 6. Example of ABAX 2 devices registered correctly.

Adding new ABAX 2 wireless devices (PERFECTA Soft)

Adding the ABAX 2 wireless keypad

1. Click on the “Hardware” tab.
2. Click on one of the unused keypads. Address of this keypad will be assigned to the wireless keypad after the adding procedure is finished.
3. Click on . The wireless device adding panel will be displayed.
4. In the “Serial no.” field, enter the serial number of the keypad.
5. Press any key on the keypad being added.
6. When the “Device’s data read” message will be displayed, click “OK”. The wireless device adding panel will close.
7. Click  to save changes.





Adding other ABAX 2 wireless devices

You can assign detectors, sirens and other wireless devices to zones 9-56. When adding a device, you will select the number of zone to which the device will be assigned. If the device occupies more than one position on the list of devices, i.e. more than one zone, additional zones will be assigned automatically (these will be zones following the selected one).

If the device is also to be assigned to an output, the output number will be assigned automatically. For zones 9-16, the output numbers are 5-12 (see: Table 7). For zones 17-56, the output number is the same as the number of the selected zone.



ABAX 2 wireless zone	ABAX 2 wireless output
9	5
10	6
11	7
12	8
13	9
14	10
15	11
16	12

Table 7. Output numbers given to ABAX 2 devices assigned to zones 9-16.



1. Click on the "Hardware" tab.
2. Click on the ABAX 2 controller name.
3. Click on the "Read" button to read data of wireless devices from the controller (controller data will not be read when you click  on the menu bar).
4. Click on . The wireless device adding panel will be displayed.
5. In the "Serial no." field, enter the serial number of the device.
6. Power on the device (install the battery in the device, turn on the device power, etc.).
7. A message will confirm that the device has been added (unless you have entered an invalid serial number, of which the message will inform you).
 - 7.1. Device type will be displayed.
 - 7.2. A new name of the zone to which the device is to be assigned will be displayed. You can change the name. If the device occupies two or more positions on the device list, the same name will be given to the other zones.
 - 7.3. If you want to change the number of the zone to which the device is to be assigned, click  in the "Zone No" field and select a number from the list.
 - 7.4. For some devices you can select if the device is to occupy one or two positions on the list of devices.
8. Click on the "OK" button. The wireless device adding panel will close.
9. Click on the "Write" button to save changes to the controller (changes will not be saved to the controller when you click  on the menu bar).
10. Click , to save changes to the control panel (zone / output name).
11. Start the device identification function (See: "Identifying devices" p. 31).

Removing ABAX 2 wireless devices (PERFECTA SOFT)

Removing the ABAX 2 wireless keypad

1. Click on the “Hardware” tab.
2. Click on the wireless keypad you want to remove.
3. Click on . The “Device deleting” window will be displayed.
4. Click on “Delete”. The „Device deleting” window will close.
5. Click  to save changes.

Removing other ABAX 2 wireless devices

1. Click on the “Hardware” tab.
2. Click on the ABAX 2 controller name.
3. Click on the “Read” button to read data of wireless devices from the controller (controller data will not be read when you click  on the menu bar).
4. Click on the device you want to remove.
5. Click on . The “Device deleting” window will be displayed.
6. Click on “Delete”. The „Device deleting” window will close.
7. Click on the “Write” button to save changes to the controller (changes will not be saved to the controller when you click  on the menu bar).
8. Start the device identification function (see: “Identifying devices” p. 31).

6.16 Installing the MICRA wireless devices

If you installed the PERFECTA-RF module on the control panel mainboard, you can install MICRA (433 MHz) wireless devices in the alarm system. You can do it after starting the control panel and identifying the devices used in conjunction with the control panel.

Before installing a wireless device, make sure that transmissions from the device positioned in the planned installation place reach the control panel. You can do it after the device is registered to the control panel (see: “Registering the MICRA devices to the controller”). To send a transmission, you can, for example, open the tamper switch on the device. If transmissions from the device in the expected place of installation do not reach the control panel, select another location. Sometimes, just moving the device ten to twenty centimeters will do. Do not secure the device permanently until making sure that the control panel receives transmissions from the device. For detailed information about installation of individual devices, please refer to the manuals of the respective products.

6.16.1 Registering the MICRA devices to the controller

All MICRA wireless devices must be registered to the control panel. You can do it using the PERFECTA SOFT program or the LCD keypad. When registering a device, you must enter its serial number. The serial number sticker is on the device (location of the sticker is indicated in the manual of the device).

The control panel supports:



- up to 4 wireless keypads,
- up to 64 wireless detectors,
- up to 4 wireless sirens.

Adding new MICRA wireless devices (PERFECTA SoFT)





If you want to add the MRU-300 repeater, proceed in the same way as when adding a wireless detector.



Adding the MICRA wireless keypad

1. Click on the “Hardware” tab.
2. Click on one of the unused keypads. Address of this keypad will be assigned to the wireless keypad after the adding procedure is finished.
3. Click on . The wireless device adding panel will be displayed.
4. In the “Serial no.” field, enter the serial number of the keypad.
5. Press any key on the keypad being added.
6. When the “Device's data read” message will be displayed, click “OK”. The wireless device adding panel will close.
7. Click  to save changes to the control panel.

Adding the MICRA wireless detector





1. Click on the “Zones” tab.
2. Click on one of the unused zones. The wireless detector will be assigned to this zone after the adding procedure is finished.
3. Click on . The wireless device adding panel will be displayed.
4. In the “Serial no.” field, enter the serial number of the detector.
5. Open momentarily the detector tamper switch.
6. When the “Device's data read” message will be displayed, click “OK”. The wireless device adding panel will close.
7. Click  to save changes to the control panel.

Adding the MICRA wireless siren

1. Click on the “Outputs” tab.
2. Click on one of the unused outputs with a number from 13 to 16. The wireless siren will be assigned to this output after the adding procedure is finished.
3. Click on . The wireless device adding panel will be displayed.
4. In the “Serial no.” field, enter the serial number of the siren.
5. Open momentarily the siren tamper switch.
6. When the “Device's data read” message will be displayed, click “OK”. The wireless device adding panel will close.
7. Click  to save changes to the control panel.



Adding new MICRA wireless devices (keypad)

1. Start the service mode (see “Starting the service mode” p. 29).
2. Press successively      to run the 1271.ADD function.
3. Enter the serial number of the wireless device.
4. Press .
5. When the “Open tamper device” command is displayed,
 - to add keypad: press any key on the keypad being added,



- to add detector or siren: open momentarily the tamper switch on the device being added.
6. The type and serial number of the device being added will be displayed (if nothing happens, you may have entered a wrong serial number – if this is the case, press , to exit the function).
 7. Press .
 8. When the “SELECT...” command is displayed, use the  and  keys to select:
 - when adding a keypad: the address to be assigned to the keypad,
 - when adding a detector: the zone to which the detector is to be assigned,
 - when adding a siren: the output to which the siren is to be assigned.
 9. Press . The device will be added.

Removing MICRA wireless devices (PERFECTA Soft)



Removing the MICRA wireless keypad

1. Click on the “Hardware” tab.
2. Click on the wireless keypad you want to remove.
3. Click on . The “Device deleting” window will be displayed.
4. Click on “Delete”. The „Device deleting” window will close.
5. Click  to save changes to the control panel.









Removing the MICRA wireless detector

1. Click on the “Zones” tab.
2. Click on the zone to which the detector you want to remove is assigned.
3. Click on . The “Device deleting” window will be displayed.
4. Click on “Delete”. The „Device deleting” window will close.
5. Click  to save changes to the control panel.

Removing the MICRA wireless siren

1. Click on the “Outputs” tab.
2. Click on the output to which the siren you want to remove is assigned.
3. Click on . The “Device deleting” window will be displayed.
4. Click on “Delete”. The „Device deleting” window will close.
5. Click  to save changes to the control panel.

Removing MICRA wireless devices (keypad)

1. Start the service mode (see “Starting the service mode” p. 29).
2. Press successively      to run the 1273.REMOVE function.
3. Use the  and  keys to select:
 - when removing a keypad: the keypad you want to remove,
 - when removing a detector: the zone to which the detector you want to remove is assigned,
 - when removing a siren: the output to which the siren you want to remove is assigned.
4. Press .

5. The type and serial number of the device to be removed will be displayed.
6. Press . The device will be removed.

7. Numeration of zones and outputs in the system

7.1 Numeration of zones

7.1.1 Hardwired zones

The zones on control panel main board have numbers from 1 to 8.

The zones in zone expanders are numbered depending on the address set in them (see: Table 2 p. 21).

7.1.2 Wireless zones

The ABAX 2 wireless devices can be assigned to zones 9-56. The MICRA wireless detectors can be assigned to zones 1-64.



If the number of a wired zone coincides with the number of a wireless MICRA zone, the wired zone will not be supported.

7.2 Numeration of outputs

7.2.1 Hardwired outputs

The outputs on control panel main board have numbers from 1 to 4.

The outputs in output expanders are numbered depending on the address set in them (see: Table 3 p. 22).

7.2.2 Wireless outputs

The ABAX 2 wireless devices can be assigned to outputs 5-12 and 17-56. The MICRA wireless sirens can be assigned to outputs 13-16.

8. Specifications

8.1 Control panel

Supply voltage	18 VAC \pm 15%, 50-60 Hz
Recommended transformer	40 VA
Standby current consumption	190 mA
Maximum current consumption	490 mA
Standby current consumption from battery	130 mA
Maximum current consumption from battery	430 mA
Power supply output voltage	12 VDC \pm 15%
Power supply output voltage range	10.5...14 VDC
Power supply output current	2 A
Battery charging current.....	500 mA
Battery failure voltage threshold.....	11 V \pm 10%
Battery cut-off voltage	10.5 V \pm 10%
High-current programmable outputs	1000 mA / 12 VDC

Low-current programmable outputs	25 mA / 12 VDC
KPD output	500 mA / 12 VDC
AUX output	500 mA / 12 VDC
Hardwired programmable zones	8
Maximum number of programmable zones.....	64
Hardwired programmable outputs.....	4
Maximum number of programmable outputs	64
Power outputs.....	2
Communication buses	1
Keypads.....	up to 4
Partitions.....	4
Telephone numbers for messaging	8
Voice messages	16
Users	62
Timers.....	8
Event log.....	3584
Security grade according to EN50131	Grade 2
Environmental class according to EN50130-5	II
Operating temperature range.....	-10...+55°C
Maximum humidity	93±3%
Electronics board dimensions	160 x 68 mm
Weight.....	110 g

8.2 PRF-LCD keypad

Supply voltage	12 VDC ±15%
Standby current consumption	30 mA
Maximum current consumption.....	50 mA
Environmental class according to EN50130-5	II
Operating temperature range.....	-10...+55°C
Maximum humidity	93±3%
Enclosure dimensions.....	139 x 124 x 22 mm
Weight.....	246 g

9. Manual update history

Manual version	Introduced changes
12/24	<ul style="list-style-type: none"> Information on the APT-210 keyfob and ETHM-1 Plus module has been added in the “Features” section (p. 5). Information on the INT-TSG2R and INT-TSH2R keypads has been added in the “Keypads” section (p. 7). Information on the ETHM-1 Plus module has been added in the “Expansion modules” section (p. 8). Information on the AFD-200 detector, APB-210 button and ART-210 thermostat has been added in the “ABAX 2 wireless devices” section (p. 9). The “Connecting the Ethernet communication module” section has been added (p. 17).
06/25	<ul style="list-style-type: none"> Information on programming of EOL resistors value and on IP zones has been

added in the “Features” section (p. 5).

- Information on the INT-TSH210 keypad has been added in the “Keypads” section (p. 7).
- Note on the PRF-LCD-A2 keypads has been added (p. 16).
- Information on the EOL resistors has been modified (p. 27).

