

# MICRA

Wireless outdoor siren

## MSP-301

Firmware version 2.00

EN

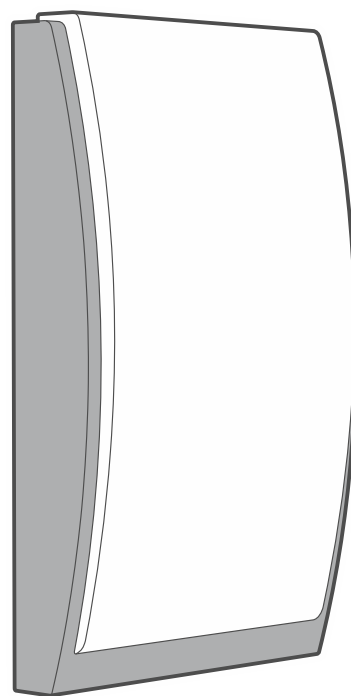

CE

mSP-301\_en 07/23

**Satel**®

SATEL sp. z o.o. • ul. Budowlanych 66 • 80-298 Gdańsk • POLAND  
tel. +48 58 320 94 00  
[www.satel.pl](http://www.satel.pl)

## IMPORTANT

The device should be installed by qualified personnel.

Prior to installation, please read carefully this manual.

Changes, modifications or repairs not authorized by the manufacturer shall void your rights under the warranty.

The rating plate of the device is located on the enclosure base.



The device meets the requirements of the applicable EU directives.



The device must not be disposed of with other municipal waste. It should be disposed of in accordance with the existing rules for environment protection (the device was placed on the market after 13 August 2005).



The device meets the technical regulations of the Eurasian Customs Union.

SATEL aims to continually improve the quality of its products, which may result in changes in their technical specifications and software. Current information about the changes being introduced is available on our website.

Please visit us at:

<https://support.satel.pl>

**Hereby, SATEL sp. z o.o. declares that the radio equipment type MSP-301 is in compliance with Directive 2014/53/EU. The full text of the EU declaration of conformity is available at the following internet address: [www.satel.pl/ce](http://www.satel.pl/ce)**

The following symbols may be used in this manual:



- note,



- caution.

## CONTENTS

1. Features .....	2
2. Description.....	2
3. Installation and start-up .....	4
4. Battery replacement.....	5
5. Specifications .....	6

The MSP-301 siren provides information about alarm situations by means of optical and acoustic signaling. The siren is supported by:

- PERFECTA alarm control panels (WRL models),
- MTX-300 controller.

## 1. Features

---

- Acoustic signaling by means of sounder.
- Optical signaling by means of LEDs.
- Encrypted radio transmissions in the 433 MHz frequency band.
- Remote configuration.
- Power supply from 3.6 V lithium thionyl chloride battery.
- Battery status control.
- Weatherproofed electronic circuit.
- Tamper protection against cover removal and tearing enclosure from the wall.
- High-impact polycarbonate enclosure, featuring a very high mechanical strength.

## 2. Description

---

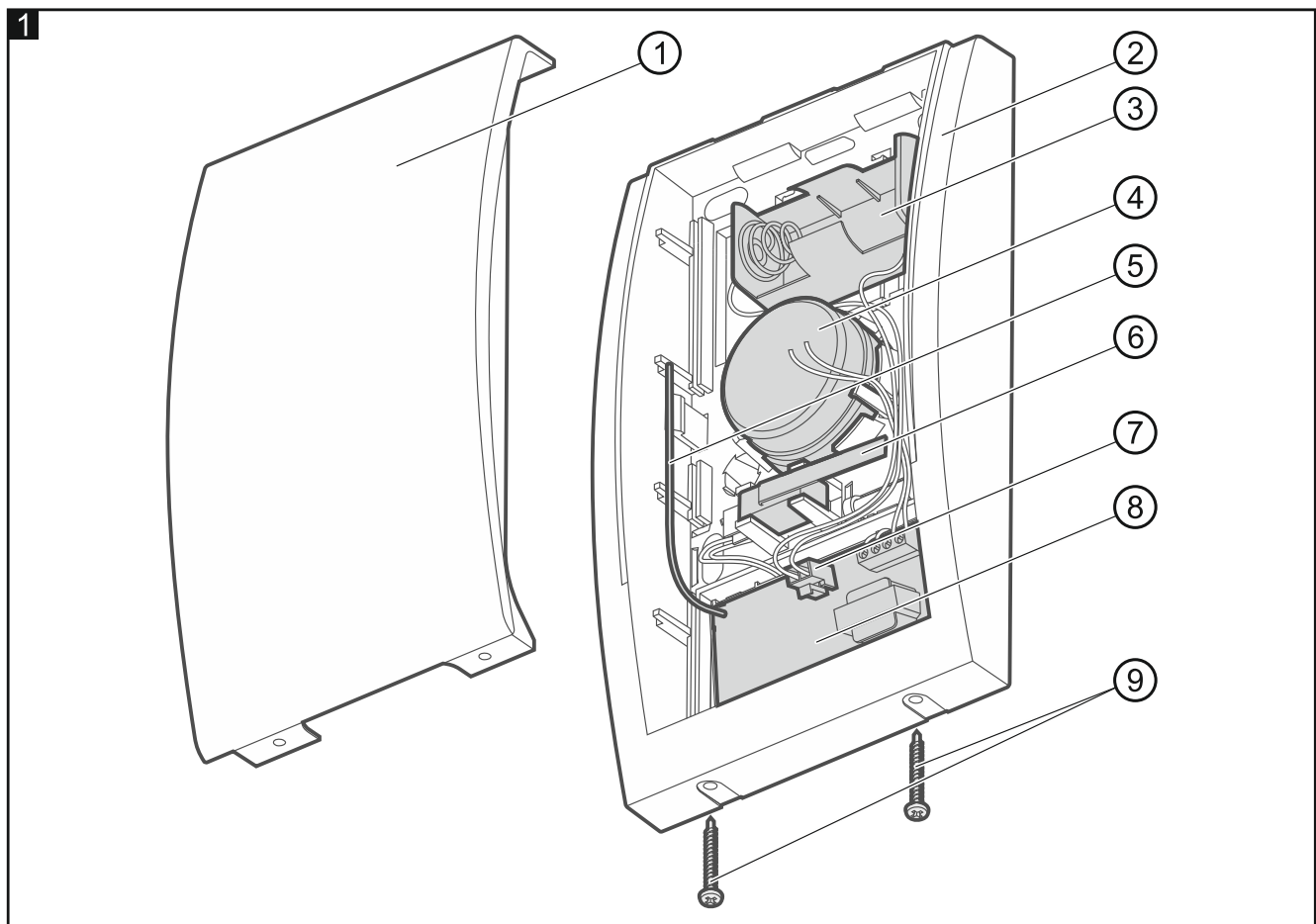

- ① enclosure cover.
- ② enclosure base.
- ③ battery holder.
- ④ sounder.

- ⑤ antenna.
- ⑥ tamper switch.
- ⑦ battery connector.
- ⑧ electronics module.
- ⑨ cover locking screws.

### Radio communication

Every 15 minutes, the siren sends information about its state (periodical transmission). Additional communication takes place when:

- the siren informs the control panel / controller about tamper (the tamper information is sent immediately),
- the control panel / controller sends a command to the siren (starting / stopping the signaling; blocking / unblocking the tamper signaling).

### Triggering the alarm signaling

The signaling is triggered:

- on receiving a radio command from the control panel / controller – optical and acoustic signaling are controlled independently;
- on opening the tamper switch – both optical and acoustic signaling is triggered.

The signaling parameters can be configured remotely (see the control panel / controller manual).





<b>1</b>	Two sound frequencies (1450 Hz/2100 Hz) alternating within 1 second.	
<b>2</b>	Sound with rising frequency (from 1450 Hz to 2100 Hz) within 1 second.	
<b>3</b>	Sound with falling frequency (from 2100 Hz to 1450 Hz) within 1 second.	
<b>4</b>	Sound with smoothly rising and falling frequency (1450 Hz – 2100 Hz – 1450 Hz) within 1 second.	

Table 1. Tone types for acoustic signaling.

### Blocking the tamper signaling

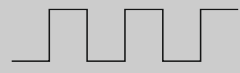
Opening the tamper switch will not trigger any signaling in the following cases:

- after installing / connecting the battery – tamper alarm signaling will only be unblocked after the standby mode entering command is received from the control panel / controller, provided that the tamper switch has been closed for 30 seconds, (the command to enter the standby mode is sent by the control panel / controller after exiting the service mode, and by the controller also after terminating communication with the MTX Soft program or after restart),
- when the control panel / controller is running in service mode or communication between the controller and the MTX Soft program is in progress.

When the tamper signaling is blocked, the leftmost LED is flashing every 10 seconds.

### Power supply

The siren is powered from a 3.6 V lithium thionyl chloride battery. It is a high-current battery, characterized by high capacity. The battery is offered by SATEL.



If you want to replace the low battery with a fresh one, follow the procedure described in the “Battery replacement” section (p. 5).

### Enclosure base

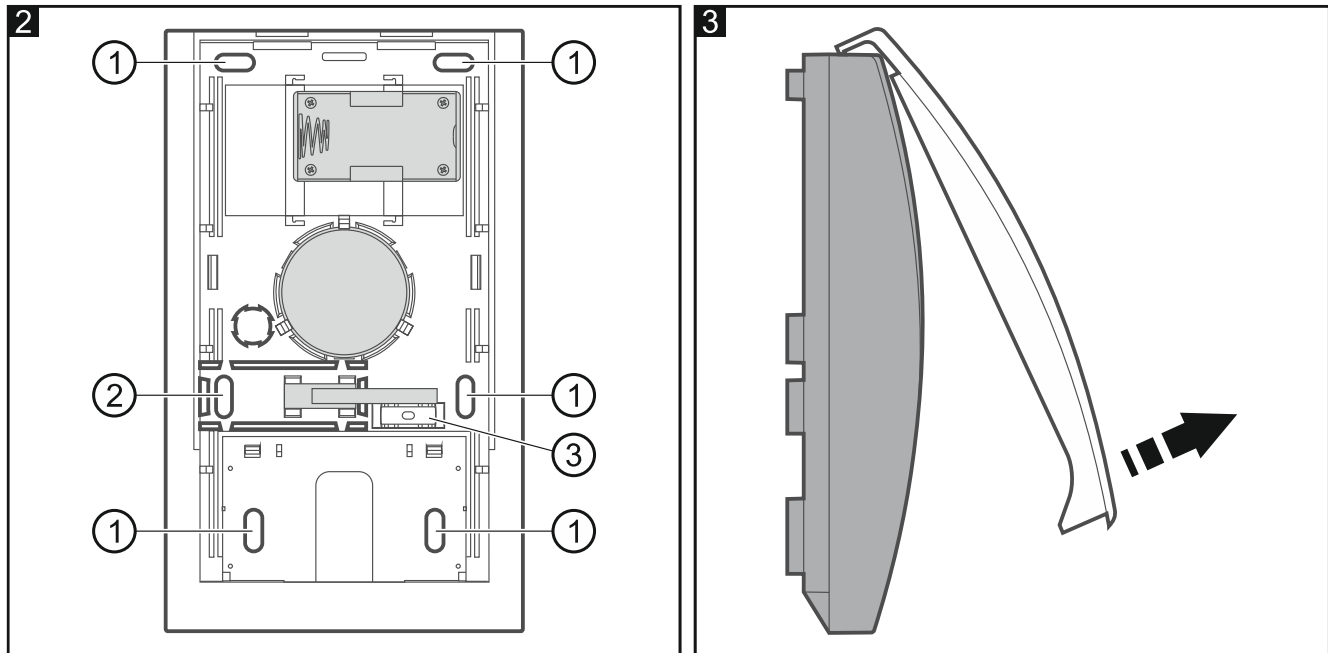

Explanations for Fig. 2:

- ① mounting hole.
- ② mounting hole for tamper protection.
- ③ spirit level.

## 3. Installation and start-up



**Never shorten or deform the antenna.**

**There is a danger of battery explosion when using a different battery than recommended by the manufacturer, or handling the battery improperly. Do not crush the battery, cut it or expose it to high temperatures (throw it into the fire, put it in the oven, etc.).**

**Do not expose the battery to very low pressure due to the risk of battery explosion or leakage of flammable liquid or gas.**

**Be particularly careful during installation and replacement of the battery. The manufacturer is not liable for the consequences of incorrect installation of the battery.**

The siren must be installed on the wall, high above the floor, at a hard to access location, so as to minimize the risk of tampering. Make sure that some free space is left above the siren (at least 2.5 cm). Otherwise, it will be impossible to replace the cover.

1. Remove the cover locking screws.
2. Lift up the enclosure cover by approx. 60° and remove it (see Fig. 3).
3. Press and hold down the tamper switch.
4. Install the battery. The leftmost LED will start flashing every second to indicate that the battery initialization procedure has begun (see also “Battery replacement”). Given the

specific character of the battery, it must be properly initialized to reach the required power supply parameters.



*The battery is to be installed just before installing the siren.*

5. When the leftmost LED on the siren starts flashing every second, release the tamper switch.
6. Register the siren in the system (see: PERFECTA control panel installer manual / MTX-300 controller manual).
7. Replace the siren cover.
8. Place the siren in the location intended for its installation.
9. Open the enclosure but do not remove the front cover. If the transmission from the siren is received, continue with the installation. If the transmission from the siren is not received, select a different mounting location and repeat the test. Sometimes, it is sufficient to shift the device ten or twenty centimeters.
10. Remove the siren cover.
11. Disconnect the battery from the electronics module.
12. Move aside the catches holding the electronics module and remove it.
13. Place the enclosure base on the wall and mark the location of mounting holes (Fig. 2). Be sure to take into account the mounting hole for tamper protection.
14. Drill the holes for wall plugs (screw anchors).
15. Secure the enclosure base to the wall with wall plugs (screw anchors) and screws. Remember about the mounting hole for tamper protection. Select appropriate wall plugs based on the type of the mounting surface (different for concrete or brick wall, different for plaster wall, etc.).
16. Secure the electronics module in the enclosure base.
17. Connect the battery to the electronics module.
18. Replace the siren cover and fasten it with screws.
19. Test the siren for proper operation.

## 4. Battery replacement

---



**The new battery must be installed as described below to run the battery initialization procedure. The required power supply parameters are only possible with the properly initialized battery.**

**The used batteries must not be discarded, but should be disposed of in accordance with the existing rules for environment protection.**

1. Start the service mode in the control panel / controller.
2. After the leftmost LED on the siren starts flashing every 10 seconds, you can open the siren enclosure.
3. Remove the discharged battery.
4. Press and hold down the tamper switch.
5. Install the new battery.
6. When the leftmost LED on the siren starts flashing every second, release the tamper switch. Flashing of the leftmost LED indicates that the first phase of battery initialization is in progress. After 5 minutes, when this phase is completed, the siren is ready for work. The second phase of battery initialization lasts 3 hours, without however limiting functionality of the siren. This phase is signaled by two flashes every 30 seconds.

## 5. Specifications

---

Operating frequency band.....	433.05 ÷ 434.79 MHz
Radio communication range (in open area) .....	up to 400 m
Battery.....	ER34615 3.6 V
Battery life expectancy .....	up to 3 years
Standby current consumption .....	0.6 mA
Maximum current consumption .....	500 mA
Sound pressure level (at 1 m distance).....	up to 105 dB
Environmental class according to EN50130-5 .....	IIIA
Operating temperature range.....	-40°C...+55°C
Maximum humidity .....	93±3%
Dimensions .....	148 x 254 x 64 mm
Weight.....	766 g