

**integra**

Alarm control panel

# INTEGRA Plus

Firmware version 1.21

EN

CE



PROGRAMMING

integra\_plus\_p\_en 11/22

**Satel** ®

SATEL sp. z o.o. • ul. Budowlanych 66 • 80-298 Gdańsk • POLAND  
tel. +48 58 320 94 00  
[www.satel.pl](http://www.satel.pl)

Before you start programming, please read carefully this manual in order to avoid mistakes that can lead to malfunction or even damage to the equipment.

SATEL aims to continually improve the quality of its products, which may result in changes in their technical specifications and software. Current information about the changes being introduced is available on our website.

Please visit us at:  
<https://support.satel.pl>

**The declaration of conformity may be consulted at [www.satel.pl/ce](http://www.satel.pl/ce)**

**Service code: 12345**

The following symbols may be used in this manual:



- note;



- caution.

## Changes made to the firmware version 1.21

<b>Keypads</b>	Support for INT-TSG2 and INT-TSH2 keypads with firmware version 2.01.
<b>Expansion modules</b>	Support for ACU-220 and ACU-280 controllers with firmware version 6.05 and 6.06.
<b>Zones</b>	The 82. ARM/DISARM type zone can control a group of partitions.
<b>Outputs</b>	<p>The 31. BATTERY TROUBLE (MAINBOARD) type output can indicate the battery's high internal resistance.</p> <p>New option: EDITION IN ART-200 (for the 120. THERMOSTAT type outputs).</p>

## CONTENTS

1.	General .....	5
2.	Configuring the control panel with keypad .....	5
2.1	Starting the service mode .....	5
2.2	Starting the service mode "from pins" .....	6
2.3	Hiding the service mode .....	6
2.4	Exiting the service mode.....	6
2.5	Service mode menu .....	6
2.6	Entering data by means of the keypad .....	25
2.6.1	Selection from the single-choice list.....	25
2.6.2	Selection from the multiple-choice list.....	25
2.6.3	Entering decimal and hexadecimal values.....	25
2.6.4	Programming telephone numbers.....	26
2.6.5	Entering names.....	27
3.	Configuring the control panel with DLOADX program.....	27
3.1	Main menu of DLOADX program .....	27
3.1.1	Buttons.....	28
3.2	Parameters related to communication between the control panel and DLOADX program .....	29
3.2.1	Communication identifiers.....	29
3.2.2	Modem communication parameters.....	29
3.2.3	Ethernet communication parameters .....	31
3.2.4	Cellular data network communication parameters .....	32
3.3	Local programming .....	34
3.3.1	Starting local programming .....	34
3.3.2	Starting local programming "from pins" .....	34
3.3.3	Finishing local programming .....	34
3.4	Remote programming .....	34
3.4.1	Starting remote programming via modem.....	34
3.4.2	Starting remote programming via Ethernet network.....	38
3.4.3	Starting remote programming via the cellular data network.....	40
3.5	Control panel data file .....	43
4.	System structure .....	43
4.1	Objects .....	43
4.2	Partitions.....	44
4.2.1	Creating partitions.....	44
4.2.2	Programming partitions.....	44
4.2.3	Partition parameters.....	44
4.3	Zones.....	47
4.3.1	Assigning zones to a partition .....	48
4.3.2	Programming the EOL resistor values .....	48
4.3.3	Programming the zones.....	49
4.3.4	Zone parameters.....	49
4.3.5	Zone types .....	51
4.3.6	Zone options .....	54
4.3.7	Counters .....	57
4.3.8	Bypasses .....	57
4.3.9	Groups of partitions.....	58
4.3.10	Zone testing .....	58
5.	Outputs .....	58
5.1	Output parameters.....	59
5.2	Output functions.....	60

5.3	Options .....	64
5.4	Output triggering .....	65
5.5	Clearing alarm in partitions .....	65
5.6	Output disabling.....	66
5.7	120. Thermostat output settings .....	66
5.7.1	Rules for programming the thermostatic output settings .....	67
5.8	Output groups.....	67
5.9	Logical functions of outputs .....	68
5.10	Output testing .....	68
6.	System options .....	68
6.1	Telephone options .....	69
6.2	Printer options .....	70
6.2.1	Printout options .....	70
6.2.2	Printout contents .....	71
6.3	Other options .....	71
6.4	Arming options.....	74
6.5	Times.....	74
6.6	Service options and parameters .....	75
6.7	Other parameters .....	75
6.8	Default user's authority level.....	76
7.	Programming the keypads.....	76
7.1	Keypad parameters and options.....	76
7.1.1	Keypad .....	76
7.1.2	Volume/filter .....	80
7.1.3	State inspections.....	80
7.1.4	User functions definition .....	81
7.1.5	Proximity cards.....	82
8.	Timers.....	83
8.1	Programming the timers .....	83
8.2	Timer parameters .....	83
9.	User schedules .....	83
10.	Reporting .....	84
10.1	Reporting parameters and options .....	85
10.1.1	Options .....	85
10.1.2	Monitoring station 1 / Monitoring station 2.....	86
10.1.3	SIA-IP .....	88
10.1.4	Identifiers assignment .....	89
10.1.5	Event codes.....	89
10.1.6	Test transmissions .....	89
10.2	Starting the reporting .....	89
10.2.1	Telephone reporting .....	89
10.2.2	Reporting via Ethernet network .....	90
10.2.3	Reporting via cellular data network .....	90
10.2.4	SMS reporting .....	92
11.	Messaging .....	92
11.1	Voice / PAGER messaging parameters and options .....	93
11.1.1	Telephone numbers .....	93
11.1.2	Events assignment .....	94
11.1.3	Clearing .....	94
11.1.4	Pager messages .....	94

---

11.1.5	Pager type.....	94
11.2	SMS messaging parameters and options .....	94
11.2.1	Events assignment.....	95
11.3	E-mail messaging parameters and options.....	95
11.3.1	Events assignment.....	95
11.3.2	E-mail server .....	95
11.4	Starting the voice messaging.....	95
12.	Answering phone calls and remote control .....	96
12.1	Telephone answering and control parameters and options .....	96
12.1.1	Users and remote switches.....	97
12.2	Activation of the phone calls answering.....	97
12.3	Activation of the remote control .....	97
13.	Control panel firmware update .....	97
14.	Manual update history.....	98

## 1. General

---

This manual applies to the control panels of the INTEGRA Plus series:

- INTEGRA 64 Plus
- INTEGRA 128 Plus
- INTEGRA 256 Plus

The control panel may be programmed:

- locally
  - LCD keypad,
  - computer with the DLOADX program installed, connected to the control panel RS-232 or USB port,
- remotely
  - computer with the DLOADX program installed, communicating via the PSTN network (modem), the cellular network (modem / LTE/GPRS transmission) or the Ethernet network. Modem communication can take place via the built-in control panel modem or an external modem connected to the control panel. The LTE/GPRS transmission is available if the INT-GSM / INT-GSM LTE module or the SATEL GSM module is installed in the alarm system. Communication via Ethernet is possible if the ETHM-1 Plus / ETHM-1 module is connected to the control panel.
  - virtual keypad available in the internet browser, mobile phone or smartphone.

Programming the control panel is possible when:

- the PERMANENT SERVICE ACCESS option is enabled (the option is enabled by default – the control panel can be programmed by any method),
- the PERMANENT DLOADX ACCESS option is enabled (the option is enabled by default – the control panel can only be programmed by means of the DLOADX program),
- the installer has been granted a temporary access to the control panel using the SERVICE ACCESS function (the control panel can be programmed by any method).



*The standards require that the administrators (masters) limit the installer access after installation is finished.*

## 2. Configuring the control panel with keypad

---

Programming the control panel with keypad (real or virtual) should be carried out using the service functions, available in the service mode menu. Some features may not be available in the virtual keypads.

### 2.1 Starting the service mode

---

1. Enter the **service code** (by default 12345) and press the **\*** key.
2. Using the **▲** or **▼** key, select the item SERVICE MODE from the list and press the **#** or **▶** key.

You can also start the service mode using the key shortcut:

[service code]\*9

The service mode is indicated in the keypads by lighting of the  LED. It can also be signaled by beeps if the appropriate option is enabled.



*In the service mode, only alarms from the 24h Vibration, 24h Cash machine, PANIC-AUDIBLE and PANIC-SILENT type zones are possible.*

## 2.2 Starting the service mode “from pins”

---

When entering the service mode in the normal way is not possible (the control panel does not support LCD keypads, does not accept the service code, etc.), you can use the emergency procedure, so-called, starting “from pins”.

1. Turn off the control panel power supply (first disconnect the AC power, and then the battery).
2. Put a jumper on the RESET pins located on the control panel mainboard.
3. Turn on the control panel power supply (first connect the battery and then the AC power). The DIALER LED will start flashing.
4. Wait a few seconds until the DIALER LED goes out and remove the jumper from the pins. The control panel will enter the service mode. The service mode menu will be displayed on the LCD keypad with the lowest address.



*The service mode will not start if:*

- *the computer with running DLOADX program is connected to the RS-232 port,*
- *the DISABLE SERVICE MODE option is enabled – in such a case a prompt will appear on the display, whether you want to delete all the control panel data. Pressing the key number 1 will restore the factory settings and then will start the service mode.*

*The service mode can be started “from pins” even if the installer does not have access (the administrator has disabled the PERMANENT SERVICE ACCESS and has not programmed the service access time). If this is the case, the installer can get access to the MASTERS function by entering the service code, confirmed by pressing the \* key, within about 20 seconds after ending the service mode started “from pins”.*

## 2.3 Hiding the service mode

---

The installer can hide the service mode using the HIDE SM NOW function (SM SETTINGS ► HIDE SM NOW). The control panel will remain in the service mode, but the service mode menu will not be displayed. This function can be useful, if e.g. the installer has to leave the keypad, but does not want unauthorized persons to have access in the meantime to the service menu. To get access to the service mode menu, you must proceed in the same way as when entering the service mode.

The service mode can be hidden automatically after a specified period of time has elapsed since the last operation was performed on the keypad (see description of the HIDE SERVICE MODE AFTER parameter p. 75).

## 2.4 Exiting the service mode

---

To exit the service mode you can use the SERVICE END function.

After exiting the service mode, the control panel verifies whether the data in RAM memory have changed in relation to the data stored in non-volatile FLASH memory. When the data in RAM have been changed, a prompt will be displayed asking whether the new settings are to be saved to FLASH memory. Pressing the key with number 1 will save a copy of the settings to FLASH memory. By saving a copy of the settings to the FLASH memory, the control panel will be able to restore them from a backup copy if an error is detected in the data stored in the RAM memory.

## 2.5 Service mode menu

---

**Service end**

**SM settings**

Service code

INTEGRA ident.  
 DLOADX ident.  
 GUARDX ident.  
 Ident. ACCO-NET  
 DLOADX tel. No  
 GUARDX tel. No  
 Block SM  
 Block DWNL  
 SM sounds  
 Hide SM now  
 Hide SM after

## Structure

### System

#### Objects

Edit object  
 New object  
 Delete object

#### Partitions

##### Settings

[select partition by name]

Type  
 Dep. partitions  
 Timers 1..32  
 Timers 33..64

##### Options

2 cds to arm  
 2 cds to d-arm  
 Codes on 2 arm  
 1st code 30s  
 Timer priority  
 Fin.exit delay  
 Infin.ex.delay  
 Def.block time  
 Al.-can disarm  
 Exit delay  
 Auto-arm delay  
 Al. verify time  
 Bell on 2nd  
 Guard – armed  
 Guard – disarm.  
 Time for guard.  
 C. mach. blk.del. / Disarm delay  
 C. mach. blk. time / Arm delay

##### Zones

Name

##### Names

[select partition by number]

## Hardware

### LCD keypads

#### Settings

[select device by name – see: p. 16]

#### Names

[select device by type and address]

DTM short  
 Tmp.alw.ld.DTM

### **Expanders**

#### **Settings**

[select device by name – see: p. 20]

ABAX confirmat.  
 INT-IT-wt.2cd.  
 Rem. RX key fobs  
 Copy RX keyfobs  
 Rem. ABAX kfobs  
 Copy ABAX kfobs

#### **Names**

[select device by type and address]

DT1 short  
 Tmp.alw.ld.DT1  
 DT2 short  
 Tmp.alw.ld.DT2

### **Identification**

LCD keypads id.  
 Expanders id.

#### **Keypads addr.**

EOL R1 resistor  
 EOL R2 resistor  
 EOL R2 resistor

### **Options**

#### **Tel. options.**

Mon. TELEPHONE  
 Mon.GPRS  
 Mon. ETHM-1  
 Messaging  
 SMS messaging  
 E-MAIL messag.  
 Modem answer.  
 Ext.mod.answ.  
 Voice answer.  
 Remote control  
 Tone dialing  
 Groud start  
 No dialton.tst  
 No answer test  
 Dbl. voice msg.  
 Double call  
 External modem  
 ISDN/GSM modem  
 Pulse 1/1.5

#### **Printer options**

Printing  
 Monitor. status  
 Names/descript  
 Wide paper  
 2400bps  
 CR+LF  
 Parity bit

Parity EVEN  
Zone alarms  
Part/mod. al.  
Arming/disarm.  
Bypasses  
Access control  
Troubles  
User functions  
System events

**Active rights****Various options**

Grade3  
Simple codes  
Notify of code  
Confirm with 1  
Autoabort msg.  
SM -> menu  
Tests -> menu  
No AC-no blght  
Fast exp. bus  
No rest. mon.  
Inf. aft. tamper  
Arm, view viol  
Arm, warn.trbl.  
Blk aft.w.code  
Troubl. memory  
Hide alarms  
Events limit.  
View clear.al.  
L.no ABAX=tamp  
No shortcuts

**Do not arm**

If verif. al.  
If tamper  
If monit. trbl.  
If batt. trbl.  
If outs. trbl.  
If other trbl.

**Times**

Global entry delay  
Global alarm time  
Suppr.arm status after  
AC loss report delay  
Tel. loss report delay

Def.block time  
Rings to answer  
Min.code length  
Prefix length  
Clock adjustm.  
Daylight saving  
Summer time  
Winter time  
Time server

Time zone  
 No t.serv.trbl  
 No SMTP trbl.  
 No SATEL trbl.  
 No LAN(AC) tr.  
 PING test  
   PING  
   PING period  
   PING tries  
 Integrate key

## Zones

### Details

[select zone by name]

EOL  
 Sensitivity [x20ms] / Pulses time / Sensitiv. [ms] / Output  
 Pulses count  
 Type  
 Entry delay / Alarm delay / Surveillan. time / Signal. delay / Bypass time /  
   Expander number / Arming mode / Group / Exit delay / Outputs group  
 Max.viol.time / Max.opening t.  
 Max.n-viol.time  
 No viol [min]  
 Partition  
 Power up delay  
 Priority / Dism.on viol.  
 Chime in exp. / No al. in kpds.  
 Video, disarmed  
 Video, armed  
 Bypass disabl.  
 Bypass no exit  
 Bell delay / Alarm if armed / Clear alarm / Restore=disarm / Alarm / Arm  
   2,3=delay  
 Auto-reset 3  
 Auto-reset 1  
 Auto-rst. clr  
 Pre-alarm / Attend verif. / No restore ev.  
 Abort delay / Part. tmp. block / Event arm fail / No viol.monit. / Arm-inactive /  
   Disarmd-monit.  
 Rest.after bell  
 Rest.aft.dis.  
 Al.on exit end / Log events / No bp. if armed / Abort voice m.  
 Al.aft.unbps. / Event in arm  
 Tamp. alw. loud  
 Monitor. delay / Chk. if can arm / Restore=bps.v. / Bypass verif.  
 Name

### Parameters

Partition  
 EOL  
 Sensit. [x20ms]  
 Type  
 Entry delay  
 Max.violat.time  
 Max.no-viol.t.

**Zone options**

[select option]

**Counters****Counter n** [n – counter number]

Max. value

Counting time

Omit recurs

**Bypasses****Group n** [n – number of bypassed group of zones]

Zones

Bypass on/off

**Test**

SIGNAL. OUTPUT

[select zone]

**Names**

[select zone by number]

**Outputs****Details**

[select output by name]

Function

Cut-off time

Polarization +

Pulsating

Latch

Timers control

Timers 33..64

Arm - no ctrl.

Off-delay tmr.

ON/OFF

Quick AC trbl.

Edit.in ART-200

Zones / Timers / Expanders / Outputs / Users / Doors / Voice mess. / Tel.  
switches (triggering)

LCD keypads / Master users / Arm mode sel. / Dialing mode (triggering)

Partitions / Burg.tst.part. (triggering)

Fire.tst.part. (triggering)

Output

Temperature 1

Temperature 2

Hysteresis

Timers

Bypass. timers

Clear in parts.

Troubles

PING trouble

No LAN cable

Name

**Parameters**

Function

Cut-off time

**Options**

[select option]

**Test**

**Names**

[select output by number]

**Outputs groups**

Group n outputs [n – number of group of outputs]

Group n name [n – number of group of outputs]

Outs state by

**Timers****Times**

[select timer by name]

**Names**

[select timer by number]

**User schedules****Settings**

[select schedule by name]

**Names**

[select schedule by number]

**Monitoring**

Mon. TELEPHONE

Mon. GPRS

Mon. ETHM-1

Dont rep. rst.

Stations

**Advanced**

Long hsk.s1t1

Long hsk.s1t2

Long hsk.s2t1

Long hsk.s2t2

Long hsk. wait.

Need ack.id.s1

Id. 6-chars s1

Source name s1

Partit.name s1

SIA evr.bl.s1A / TELIM 0ton s1A

SIA evr.bl.s1B / TELIM 0ton s1B

Need ack.id.s2

Id. 6-chars s2

Source name s2

Partit.name s2

SIA evr.bl.s2A / TELIM 0ton s2A

SIA evr.bl.s2B / TELIM 0ton s2B

National chars

**Station 1**

Tel. 1 number

Tel. 2 number

Tel. 1 format

Tel. 2 format

IP address

Port

Key (MS)

Key (GPRS)

Key (ETHM)

UDP

SIA-IP

SIA-IP acct  
 MAC  
 Coded  
 Key (SIA-IP)  
 KeyHEX (SIA-IP)  
 Timestamp  
 SIA-IP test  
 Ev.independent  
 Repetition cnt.  
 Suspension time  
 TELIM/SIA prefix  
 Identifier n [n – identifier number]  
 Identifier sys.  
 Event assign.

### Station 2

Tel. 1 number  
 Tel. 2 number  
 Tel. 1 format  
 Tel. 2 format  
 IP address  
 Port  
 Key (MS)  
 Key (GPRS)  
 Key (ETHM)  
 UDP  
 SIA-IP  
 SIA-IP acct  
 MAC  
 Coded  
 Key (SIA-IP)  
 KeyHEX (SIA-IP)  
 Timestamp  
 SIA-IP test  
 Ev.independent  
 Repetition cnt.  
 Suspension time  
 TELIM/SIA prefix  
 Identifier n [n – identifier number]  
 Identifier sys.  
 Event assign.

### Id. assignment

#### Partitions

[select partition]

#### Zones

[select zone]

#### LCD keypads

[select keypad]

#### Expanders

[select expander]

TELIM codes

### Event codes

Identifier n [n – identifier number]

#### Zones

[select zone]

**Partitions**

[select partition]

**LCD keypads**

[select keypad]

**Expanders**

[select expander]

**Identifier sys.**

Troubles

Troubles rst.

Other

Test at

Test MS1 every

Test MS2 every

Independ.test

**Messaging**

Messaging

Dbl.voice msg.

Repetition cnt.

Tel. names

[select telephone by number]

**Tel. settings**

[select telephone by name]

Tel. number

Type

Rounds count

Any code

Code

**Assignment**

Zone alarms

Synthesizer

Pager message

Telephones

Zone tampers

Synthesizer

Pager message

Telephones

Panic alarms

Synthesizer

Pager message

Telephones

Fire alarms

Synthesizer

Pager message

Telephones

Medical alarms

Synthesizer

Pager message

Telephones

Duress alarms

Synthesizer

Pager message

Telephones

- Tampers
  - Synthesizer
  - Pager message
  - Telephones
- AC (230V) loss
  - Synthesizer
  - Pager message
  - Telephones
- AC (230V) rest.
  - Synthesizer
  - Pager message
  - Telephones
- Outputs
  - Synthesizer
  - Pager message
  - Telephones
- Arming failed
  - Synthesizer
  - Pager message
  - Telephones

**Messages**

- [select message]

**Pager types**

- [select pager]

**Msg.abort in P.**

- [select telephone by name]

**Msg.abort on T.**

- [select telephone by name]

**SMS messaging**

- SMS messaging

- Tel. names

- [select telephone by number]

- Tel. settings

- [select telephone by name]

**E-MAIL messag.**

- E-MAIL messag.

- E-mail address

- [select e-mail address]

- Settings

- [select e-mail address]

- Active

- Zone alarms

- Bypasses

- Part/mod. al.

- Arming/disarm.

- Troubles

- System events

- Partitions

- Server (SMTP)

- Port

- User name

- Password

- Sender address

Encryption

Subject

### **Tel.answ./ctrl.**

Voice answer.

Double call

Rings count

On armed part.

Remote control

Users (all)

[select user from the list of all users]

Users (t.code)

[select user from the list of users with telephone code]

### **Note**

Text

Valid

From

For

Who can erase

### **System status**

Partitions

Zones

Troubles

Supply voltage

Radio devices

STM prg.version

IP/MAC/IMEI/ID

Modules version

### **Restarts**

Clear all

Clear settings

Clear codes

Settings<-FLASH

**STARTER**

### **Devices connected to the keypad bus**

[service code]\*9 ► Structure ► Hardware ► LCD keypads ► Settings

### **INT-KLCD / INT-KLCDR / INT-KLCDK / INT-KLCDL / INT-KLCDS / INT-KLFR / INT-KSG**

Partitions

Alarms

Fire alarms

Chime zones

Chime bps. zone

Chime bps. time

Quickarm part.

Fin.exit delay

Show entry del.

Show exit delay

Sign.entry del.

Sign.exit delay

DateTime format

Name (2nd row)

LCD backlight

Keys backlight

Auto backlight

**Alarm messages**

Part. al.mess.

Zone al.mess.

Code + card

**Alarms**

Fire alarm

Medical alarm

Panic alarm

Silent panic

3 wrong codes

**Options**

Alarm signal.

New trbl.sign.

Key sounds

Trbl.in p.arm.

Zone violation

Auto-arm delay

Unkn. card sig.

Ev.3 unk. cards

Al.3 unk. cards

Dspl. mode chg.

Show code ent.

Show disarming

Show arm

Control (8#)

**RS communicat.**

(does not apply to INT-KSG)

Sound volume

(only INT-KLCD, INT-KLCDR, INT-KLFR and INT-KSG)

**Reviews**

Zones

Partitions

Alarms log

Troubles log

Troubles

Chime changing

State part.

Zone characters

Part.characters

**Code+arrows**

Sensitivity

(only INT-KLCDR with firmware version 1.06 or newer or INT-KLFR)

Card close

Card close long

Door to open

Tamper in part.

Z1 (n) in LCD

[n – number of zone in the system]

Z2 (n) in LCD

[n – number of zone in the system]

**INT-KWRL2 / INT-KWRL**

Partitions

Alarms

Fire alarms

Chime zones

Chime bps. zone

Chime bps. time

Quickarm part.

Fin.exit delay

Show entry del.

Show exit delay

Sign.entry del.

Sign.exit delay

DateTime format

Name (2nd row)

LCD backlight

Keys backlight

### **Alarm messages**

Part. al.mess.

Zone al.mess.

Code + card

### **Alarms**

Fire alarm

Medical alarm

Panic alarm

Silent panic

3 wrong codes

### **Options**

Alarm signal.

New trbl.sign.

Key sounds

Trbl.in p.arm.

Zone violation

Auto-arm delay

Unkn. card sig.

Ev.3 unk. cards

Al.3 unk. cards

Show code ent.

Show disarming

Show arm

Control (8#)

Sound volume

### **Reviews**

Zones

Partitions

Alarms log

Troubles log

Troubles

Chime changing

State part.

Zone characters

Part.characters

### **Code+arrows**

Sensitivity

Card close

Card close long

Door to open

Tamper in part.

**CA-64 PTSA**

Zones  
 Partitions  
 Alarms  
 Show  
 AC loss delay  
 RS communicat.  
 Tamper in part.

**ETHM-1 Plus / ETHM-1**

DHCP  
 IP address  
 Netmask  
 Gateway  
 DHCP-DNS  
 DNS  
 LAN cable delay  
 Port (WWW)  
 Port (DLOADX)  
 Port (others)  
 Port (integr.)  
 Key (GUARDX)  
 Key (others)  
 Connect DLOADX  
 Connect GUARDX  
 Connect Intern.  
 Connect GSM  
 PING test  
 INTEGRUM (only ETHM-1 Plus)  
 Integrate  
 Coded integr.  
 SATEL server (only ETHM-1 Plus)  
 PUSH messages (only ETHM-1 Plus)  
 Change ID (only ETHM-1 Plus)  
 Fail. – event  
 Fail. – alarm  
 Code+arrows (only ETHM-1 Plus)  
 Tamper in part.

**INT-GSM / INT-GSM LTE**

SIM1  
 SIM2  
 Port (DLOADX)  
 Port (others)  
 Key (GUARDX)  
 Key (others)  
 Connect DLOADX  
 Connect GUARDX  
 Connect GSM  
 INTEGRUM  
 SATEL server  
 PUSH messages  
 SMS messaging  
 Change ID  
 Code+arrows

Tamper in part.

### **INT-RS / INT-RS Plus**

DSR control

RX control

Tamper in part.

### **Devices connected to the expander bus**

[service code]\*9 ► Structure ► Hardware ► Expanders ► Settings

### **INT-CR / INT-IT / INT-IT-2**

Partit. LED R

Partit. LED G

Partit. LED Y

Master users

Users

#### **Signalling**

Alarm (latch)

Alarm (time)

Entry delay

Exit delay

Auto-arm delay

Hardw. signal

Force arm

Al. 3 unk .cards

No autorst.3t.

Tamper in part.

### **INT-S / INT-SF / INT-SK / INT-SCR**

Lock feature

#### **Lock**

Lock function

Relay ON time

Relay type (does not apply to INT-SCR)

Unauth. event

Unauth. alarm

Max. door open

Dependent door1

Dependent door2

Doors on fire

Master users

Users

Code + card (only INT-SCR)

Code + card

Code or card

Follow output [n] [n – number of output]

#### **Alarms**

Fire alarm

Medical alarm

Panic alarm

Silent panic

3 wrong codes

#### **Options**

Quick arm

Fin.exit delay

BI outs ctrl.  
 MONO outs ctr.  
 Part.blocking  
 Guard control  
 Changing code  
 Code\* not dis.  
 Code\* in arm  
 Code#->Code\* (only INT-SCR)

### **Signalling**

Alarm (latch)  
 Alarm (time)  
 Entry delay  
 Exit delay  
 Auto-arm delay  
 Code entered  
 Chime zones

Confirmation

Backlight

Auto backlight

No autorst.3t.

Partition

### **INT-SZ / INT-SZK**

#### **Lock**

Lock function  
 Relay ON time  
 Relay type  
 Unauth. event  
 Unauth. alarm  
 Max. door open  
 Dependent door1  
 Dependent door2

Doors on fire

Master users

Users

#### **Alarms**

Fire alarm  
 Medical alarm  
 Panic alarm  
 Silent panic  
 3 wrong codes

#### **Options**

BI outs ctrl.  
 MONO outs ctr.  
 Part.blocking  
 Guard control  
 Changing code

#### **Signaling**

Code entered  
 Chime zones

Confirmation

Backlight

Auto backlight

No autorst.3t.

Partition

## **INT-ENT**

Master users

Users

3 wrong codes

BI outs ctrl.

MONO outs ctr.

Guard control

### **Signalling**

Delay act. time

Code entered

Confirmation

Backlight

Delay act. time

No autorst.3t.

Partition

## **INT-R / CA-64 SR / CA-64 DR**

Lock feature

### **Lock**

Lock function

Relay ON time

Unauth. event

Unauth. alarm

Max. door open

Dependent door1

Dependent door2

Doors on fire

Master users

Users

### **Readers**

Reader A (does not apply to CA-64 DR and INT-R being used as CA-64 DR)

Reader A sound

Reader A LED

Reader A arms

Reader B

(does not apply to CA-64 DR and INT-R being used as CA-64 DR)

Reader B sound

Reader B LED

Reader B arms

Al. rdrs tamper (does not apply to CA-64 DR and INT-R being used as CA-64 DR)

Hardw. signal.

3 wrong codes

BI outs ctrl.

MONO outs ctr.

Part. blocking

Guard control

Code\* not dis.

Code\* in arm

C.long not dis

### **Signalling**

Alarm (latch)

Alarm (time)

Entry delay

Exit delay

Auto-arm delay

Chime zones

No autorst.3t.

Partition

### **INT-RX / INT-RX-S / INT-VG**

No autorst.3t.

Partition

### **ACU-120 / ACU-270 / ACU-100 / ACU-250**

No autorst.3t.

Tamper in part.

Response period

High jam sens.

New device

Use ARU-100

#### **Active mode**

[select zone to which wireless device is assigned]

#### **Settings**

[select zone to which wireless device is assigned]

#### **Filter**

[select zone to which wireless device is assigned]

#### **Remove device**

[select zone to which wireless device is assigned]

Synchronization

Test mode on

Test mode off

### **ACU-220 / ACU-280**

No autorst.3t.

Tamper in part.

Response period

No jam detect.

High jam sens.

No updates

New device

Use ARU-100

#### **Active mode**

[select zone to which wireless device is assigned]

#### **Settings**

[select zone to which wireless device is assigned]

#### **Filter**

[select zone to which wireless device is assigned]

#### **ECO**

[select zone to which wireless device is assigned]

#### **Remove device**

[select zone to which wireless device is assigned]

Test mode on

Test mode off

### **CA-64 E / INT-O / CA-64 O / INT-ORS / INT-IORS (v. 1.00/1.01) / INT-ADR / CA-64 SM**

No autorst.3t.

Tamper in part.

### **CA-64 Ei (v. 2.00/2.01)**

No autorst.3t.

Tamper in part.

EOL Rp resistor

**CA-64 Ei** (v. 4.00)

No autorst.3t.  
 Tamper in part.  
 EOL R1 resistor  
 EOL R2 resistor

**INT-E / INT-IORS** (v. 2.00) / **INT-PP**

No autorst.3t.  
 Tamper in part.  
 EOL R1 resistor  
 EOL R2 resistor  
 EOL R3 resistor

**CA-64 EPS / INT-ADRPS / CA-64 ADR / INT-OPS / CA-64 OPS / IN-ORSPS / CA-64 PP**

No autorst.3t.  
 Tamper in part.  
 AC loss delay

**CA-64 EPSi** (v. 2.00/2.01)

No autorst.3t.  
 Tamper in part.  
 EOL Rp resistor  
 AC loss delay

**CA-64 EPSi** (v. 4.00)

No autorst.3t.  
 Tamper in part.  
 EOL R1 resistor  
 EOL R2 resistor  
 AC loss delay

**INT-EPS / INT-IORSPS / INT-PPPS**

No autorst.3t.  
 Tamper in part.  
 EOL R1 resistor  
 EOL R2 resistor  
 EOL R3 resistor  
 AC loss delay

**INT-KNX**

No autorst.3t.  
 Partition  
 KNX control  
 Out addresses  
 Outputs  
 Telegrams  
 Factory sets

**INT-AV**

INT-AV code  
 Verify s1A  
 Code=1tone s1A  
 Verify s1B  
 Code=1tone s1B  
 Verify s2A  
 Code=1tone s2A  
 Verify s2B  
 Code=1tone s2B

**Options**

Microphone n [n = microphone number (1...4)]

Speaker n [n = speaker number (1...4)]  
 Only listen  
 AVT buttons  
 Sound signal.  
 Silent alarm  
 Satel commands  
 Wait aft.event  
 Wait aft.disc.  
 Runtime  
 No autorst.3t.  
 Tamper in part.

## 2.6 Entering data by means of the keypad

Data are saved to the control panel if you press the # key (in some keypads, the  key is also available, whose function is exactly the same). The \* key enables exiting the function without saving any changes.

Described below are general rules for entering data, however they may be different as regards some functions.

### 2.6.1 Selection from the single-choice list

The upper line of display shows the function name, and the lower one – the currently selected item. To scroll through the item list, use the ▼ keys (down) and the ▲ keys (up). The ► and ◀ keys are not used.



### 2.6.2 Selection from the multiple-choice list

The functions that allow you to make multiple choice can be identified by an additional symbol situated at the right-hand side of the display:

-  – displayed item is selected / option is enabled,
- – displayed item is not selected / option is disabled.

Pressing any digit key (for some functions, this does not work with the key 0) will change the currently displayed symbol to the other one. To scroll through the list of items, use the ▼ key (down) or the ▲ key (up). For some functions, pressing the key 0 will allow you to enter the number of item to be edited (e.g. the number of partition or zone). This will speed up search.

For some functions, pressing the ► or ◀ key will switch the keypad into the **graphic programming mode**. The  and • symbols are used to present on the display the current status of up to 32 items available in the given function (these can be e.g. zones, outputs, timers, etc.). The ► key moves the cursor to the right, and the ◀ key to the left. If the list of items is longer than 32, pressing the ► key when the cursor is placed over the last item will display the next list, and pressing the ◀ key when the cursor is placed over the first item will display the previous list. Pressing the key 0, 1 or 2 three times in the graphic mode within 3 seconds will have the following effect:

- 000** - the • symbol will be displayed at all available items,
- 111** - the  symbol will be displayed at all available items,
- 222** - reversal of the selection made: the  symbol will be displayed at all items where the • symbol was displayed, and the • symbol where the  symbol was displayed.

On pressing the ▼ or ▲ key, the keypad will return to the text mode.

### 2.6.3 Entering decimal and hexadecimal values

Digits are entered by pressing the suitable keys. Characters from A to F are available under the keys with numbers 2 and 3. Keep pressing the keys until the required character appears.

### 2.6.4 Programming telephone numbers

Keep pressing particular keys until the required character appears. Characters available in the keypad are presented in Table 1. Up to 16 characters can be programmed. Some of the special characters (a, b, c, d, # and \*) are coded so that the character takes up two items, hence the maximum number of characters available for entering, if they are used, will be lower.

Shown on the left side in the upper line of the display is information about the letter case: [ABC] or [abc] (it will be displayed after pressing the ▼ key, which changes the letter case, and will be visible for a few seconds after the last keystroke).

The ► key moves the cursor to the right, and the ◀ key – to the left. The ▲ key deletes the character on the left side of the cursor.

Characters available after next keystroke							
mode [ABC]				mode [abc]			
key				key			
1	1	#		1	1	#	
2	2	B	C	2	2	a	b c
3	3	D	E F	3	3	d	
4	4			4	4		
5	5			5	5		
6	6			6	6		
7	7			7	7		
8	8			8	8		
9	9			9	9		
0	0	*		0	0	*	

Table 1. Characters available in the keypad when entering telephone numbers (to change the letter case, press ▼).

Special character	Function description
B	switch-over to pulse dialing
C	switch-over to tone dialing (DTMF)
D	waiting for additional signal
E	3 second pause
F	10 second pause
*	signal * in DTMF mode
#	signal # in DTMF mode
a b c d	other signals generated in DTMF mode

Table 2. Special character functions.

**i** Do not program the B and C characters before the telephone number. The control panel is dialing the number according to the settings of telephone options. These characters should be used, if the number dialing method must be changed during the process of dialing.

### 2.6.5 Entering names

Keep pressing the key until the required character appears. Characters available in the keypad are presented in Table 3. Hold down the key to display the digit assigned to the key. Shown on the left side in the upper line of the display is information about the letter case: [ABC] or [abc] (it will be displayed after pressing any key and will be visible for a few seconds after the last keystroke).

The ► key moves the cursor to the right, and the ◀ key – to the left. The ▲ key deletes the character on the left side of the cursor.

Key	Characters available after next keystroke																			
1	!	?	'	`	←	"	{	}	\$	%	&	@	\	^		☒	#	1		
2	a	b	c	2																
3	d	e	f	3																
4	g	h	i	4																
5	j	k	l	5																
6	m	n	o	6																
7	p	q	r	s	7															
8	t	u	v	.	☒	■	☒	↑	←	→	↓	8								
9	w	x	y	z	9															
0	.	,	:	;	+	-	*	/	=	_	<	>	(	)	[	]	0			

Table 3. Characters available when entering names. The lower case letters are available under the same keys (to change the letter case, press ▼ key).

## 3. Configuring the control panel with DLOADX program

Required program version: 1.21.000 (or newer).

Access to the program is protected by a code (password). To obtain access at the first run of the program, enter the factory default code: 1234 (you need not enter the factory code, just click on the “OK” button).

**i** | *The factory access code to the program should be changed as soon as possible.  
Entering an invalid code three times will terminate the program.*

### 3.1 Main menu of DLOADX program

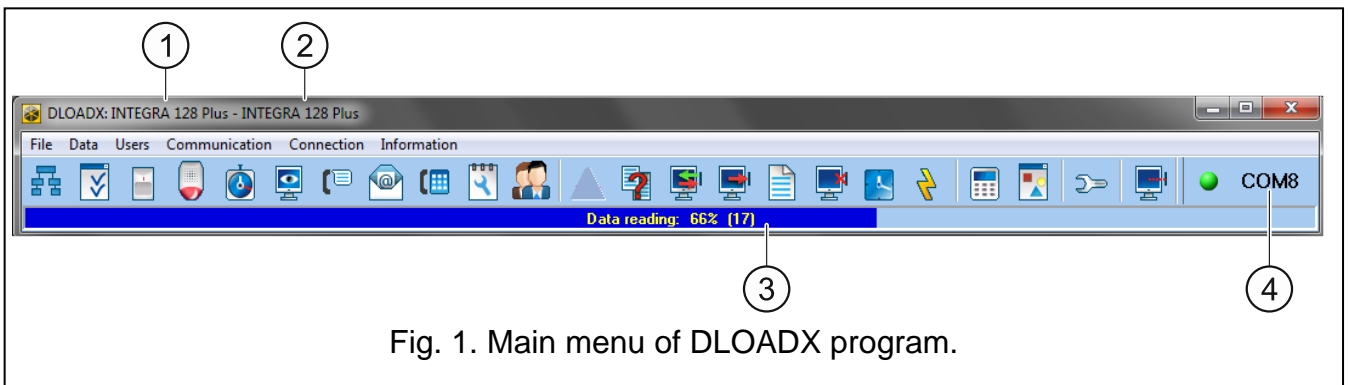























Fig. 1. Main menu of DLOADX program.

- ① type of alarm control panel.
- ② name of alarm system / data file.
- ③ information on data writing/reading progress.

④ information on the way of communication with the alarm control panel.

### 3.1.1 Buttons

	opens the "Structure" window.
	opens the "Options" window.
	opens the "Zones" window.
	opens the "Outputs" window.
	opens the "Timers" window.
	opens the "Reporting" window.
	opens the "Messaging" window.
	opens the "E-mail messaging" window.
	opens the "Answering and remote control" window.
	opens the "Service note" window.
	opens the "Users" window.
	opens the window with information on errors made when configuring the alarm system
	opens the "Data comparison" window.
	reading/updating of data from the control panel.
	data writing to the control panel.
	opens the "Event log" window.
	terminates the data reading/writing.
	saves the time in the control panel, based on the computer clock.
	writes data into the control panel FLASH memory.
	displays a virtual keypad.
	opens the drop-down menu, which makes available some tools to supervise the system state.



opens the “Configuration” window, if the program does not communicate with the control panel, or communicates with it through COM port or modem. Otherwise, the current connection window will open.



*Opening the “Configuration” window will close the COM port, which was previously selected for communication. Closing the window will open the COM port.*



opens the drop-down menu, where you can select the method of establishing communication between the program and the alarm control panel.



- enables/disables the COM port,
- opens the connection information window (remote programming).

Color of the button icon has the following meanings:

green – ready to send data,

alternating green and yellow – data transmission in progress,

red – no communication with the control panel,

gray – COM port disabled.

## 3.2 Parameters related to communication between the control panel and DLOADX program

### 3.2.1 Communication identifiers

The DLOADX program will establish communication with the control panel if:

- the communication identifiers in the control panel have their factory default value – the program will suggest then randomly generated identifiers (which you can accept or enter your own ones),
- the communication identifiers in the program and in the control panel are identical.

### Programming the communication identifiers

The identifiers can be programmed:

- keypad: functions available in the SM SETTINGS submenu (SERVICE MODE ► SM SETTINGS).
- DLOADX program: “Connection settings” window (the command for opening this window is available in the “Communication” menu; you can also use the Ctrl+R key combination).

### Description of communication identifiers

**INTEGRA identifier** – identifier of the alarm control panel. It must consist of 10 characters (digits or letters from A to F). It makes it possible to recognize the control panel and match a data file to it, if the data file has been saved on the computer. Do not program the same identifier for different control panels which are operated from the same computer (the DLOADX program will be incapable of distinguishing between them).

**DLOADX identifier** – identifier of the computer with DLOADX program. It must consist of 10 characters (digits or letters from A to F). The control panel will only establish connection with the program which uses the valid identifier.

### 3.2.2 Modem communication parameters

#### Programming the parameters

##### *Telephone numbers*

You can program the telephone numbers:

- keypad: functions available in the SM SETTINGS submenu (SERVICE MODE ► SM SETTINGS).

- DLOADX program: “Connection settings” window (the command for opening this window is available in the “Communication” menu; you can also use the Ctrl+R key combination).

### ***Control panel settings***

You can configure the modem communication settings when programming the telephone options (see: “Telephone options” p. 69).

### ***DLOADX program settings***

You can configure the modem communication settings in the “Configuration” window, “Modem” tab.

## **Description of parameters**

### ***Telephone numbers***

**Panel’s tel. no** – telephone number of the control panel.

**PC phone number** – telephone number of the modem connected to computer with DLOADX program installed.

### ***Control panel settings***

Parameters and options related to modem communication are described in section “Telephone options” (p. 69).

### ***DLOADX program settings***

You can define three sets of parameters for the modem connected to computer:

- analog modem for communication with the built-in modem of the control panel,
- analog modem for communication with the external modem of the control panel,
- ISDN or GSM modem for communication with the ISDN or GSM modem of the control panel.

After clicking on the  button you can configure the selected set of parameters (see: “Configuring the modem connected to computer”).

**Dialing** – the method of dialing numbers by the modem connected to computer (tone or pulse).

**Dial tones control** – if option is enabled, the modem connected to computer will detect the dial tone or busy signal before dialing the number.

**Speaker** – operating mode of the modem speaker. The speaker can be always OFF, or ON until connection with the control panel is established (auto), or always ON.

**Volume** – volume of modem speaker.

**Answering** – how the DLOADX program reacts when the control panel is connecting to the program. Communication can be established automatically after a preset number of rings, or the program will only indicate an attempt to establish communication by the control panel (communication will only be established after clicking on the “Answer” button).

**Double call** – you can define duration of the pause between the first and the second call, if the control panel is set to go off-hook after the second call.

### ***Configuring the modem connected to computer***

 | You can edit the parameters after clicking on the “Change” button.

**Port RS-232** – computer COM port to which the modem is connected.

**Modem** – list of modems, the parameters of which are defined. The list of modems and their settings will be written to disk in the “modem.ini” file.

**Baud Rate** – transmission rate of the serial port. It is recommended that the highest rate acceptable by the modem be set (only some modems may require the 300 bps setting in order to enforce operation with exactly this speed).

**Reset command** – the command to reset the modem. Typically, it is the **ATZ** command (reset with restoration of the user's zero profile). Some modems may require using the **AT&F** command (reset with restoration of the factory default settings).

**Initializing** – lines containing the modem initialization commands:

**for communication with built-in control panel 300 bps modem:** in the first line **E0V1Q0** – a command required for proper operation of the modem. You should also add the operating mode selection: **B0** or **B1** (selection of transmission format: V.21 or Bell103), and the commands limiting transmission rate over telephone line to 300 bps. These are commands specific for the given modem model, e.g. **N0S37=3, F1** or **+MS=1,0,300,300** etc. Information on how to limit the modem transmission rate is usually included in the device manual. The other line should contain the following commands: **S0=0S9=1S7=120S10=255**. They are necessary for correct operation.

**for communication with external analog modem connected to the control panel:** in the first line **E0V1Q0**, the second line **S0=0S7=120**. It is not recommended to insert additional commands to limit the modem transmission rate, unless this is required by the modems used, or the telephone link quality.

**for communication through ISDN or GSM modem:** in the first line **E0V1Q0**, the second line **S0=0**. Depending on the modems used, **you will have to use additional commands to set the identical transmission format, as in the control panel modem, i.e. specific for the given modem**. V.110 format is intended for the GSM modems.

**Modem ISDN** – enable this option, if communication is to be effected through an ISDN or GSM modem.

### 3.2.3 Ethernet communication parameters

#### Programming the parameters

##### *Control panel settings*

Settings related to working in conjunction with the Ethernet module which enables communication over Ethernet can be configured when programming the telephone options (see: "Telephone options" p. 69).

##### *Ethernet module settings*

For description of the configuring, please refer to the Ethernet module manual.

##### *DLOADX program settings*

The settings for communication using the ETHM-1 Plus / ETHM-1 module can be configured in the "Connection settings" window (the command for opening this window is available in the "Communication" menu; you can also use the Ctrl+R key combination).

#### Description of the parameters

##### *Control panel settings*

Options related to working in conjunction with the Ethernet module are described in section "Telephone options" (p. 69).

##### *Ethernet module settings*

For description of parameters and options, please refer to the Ethernet module manual.

### **DLOADX program settings**



*These settings apply not only to communication via Ethernet but also via cellular data network, provided that the INT-GSM / INT-GSM LTE module is connected to the ETHM-1 Plus module.*

#### **TCP/IP connection: DLOADX – ETHM/INT-GSM**

The settings below apply to direct communication with the module.

**Connection** – select the set of parameters that will be used for establishing communication: SERVER, PORT and DLOADX KEY.

**LAN/WAN** – you can enter the parameters yourself. These can be parameters needed for the Wide Area Network (WAN) or Local Area Network (LAN) communication.

**LAN: ETHM-1, Address n** [n=module address] – settings of the ETHM-1 Plus / ETHM-1 module with the given address will be used (the module network address will not be read if it is downloaded from the DHCP server). These settings can only be used for the needs of LAN communication.

**Server** – address of the Ethernet module. If the Ethernet module is not in the same local network as the computer with DLOADX program, it must be a public address. You can enter either the IP address or the domain name.

**Port** – the number of TCP port used for communication between the control panel and computer with DLOADX program using the ETHM-1 Plus (INT-GSM / INT-GSM LTE module connected to the ETHM-1 Plus) / ETHM-1 module. You can enter a value from 1 to 65535. Default value: 7090.

**DLOADX key** – a string of up to 12 alphanumeric characters (digits, letters and special characters), used for data encryption during communication between the control panel and the computer with DLOADX program using the ETHM-1 Plus / ETHM-1 / INT-GSM / INT-GSM LTE module.

#### **SATEL server**

The settings below apply to communication with the module via the SATEL server.

**Connection** – select the set of parameters that will be used for establishing communication: ETHM-1 ID, ETHM-1 MAC and DLOADX KEY.

**MAC (ETHM-1)** – you can enter the parameters yourself.

**Module: ETHM-1, Address n** [n=module address] – settings of the ETHM-1 Plus module with the given address will be used.

**ETHM-1 ID** – individual identification number assigned to the ETHM-1 Plus module by the SATEL server.

**ETHM-1 MAC** – hardware address of Ethernet module.

**DLOADX key** – a string of up to 12 alphanumeric characters (digits, letters and special characters), used for data encryption during communication between the control panel and the computer with DLOADX program using the ETHM-1 Plus / ETHM-1 / INT-GSM / INT-GSM LTE module.

### **3.2.4 Cellular data network communication parameters**

#### **Programming the parameters**

##### **Control panel settings**

Settings related to working in conjunction with the INT-GSM / INT-GSM LTE module / GSM module which enables cellular data network communication (LTE/GPRS) can be configured when programming the telephone options (see: “Telephone options” p. 69).

### ***INT-GSM / INT-GSM LTE module / GSM module settings***

For description of parameters and options, please refer to the INT-GSM / INT-GSM LTE module / GSM module manual.

### ***DLOADX program settings***

The settings for communication using the INT-GSM / INT-GSM LTE module can be configured in the “Connection settings” window (the command for opening this window is available in the “Communication” menu; you can also use the Ctrl+R key combination).

Settings related to communication via the GSM module are configured when establishing connection.

## **Description of the parameters**

### ***Control panel settings***

Options related to working in conjunction with the INT-GSM / INT-GSM LTE module / GSM module are described in section “Telephone options” (p. 69).

### ***INT-GSM / INT-GSM LTE module / GSM module settings***

For description of parameters and options, please refer to the INT-GSM / INT-GSM LTE module / GSM module manual.

### ***DLOADX program settings***



*These settings apply to communication using the INT-GSM / INT-GSM LTE module connected to the keypad bus of the control panel. The settings do not apply to the INT-GSM / INT-GSM LTE module connected to the ETHM-1 Plus module, or the SATEL GSM module.*

## **TCP/IP connection: DLOADX – ETHM/INT-GSM**

The settings below apply to direct communication with the module.

**Connection** – select the set of parameters that will be used for establishing communication: PORT and DLOADX KEY.

**LAN/WAN** – you can enter the parameters yourself.

**GSM: INT-GSM, Address n** [n=module address] – settings of the INT-GSM / INT-GSM LTE module with the given address will be used.

**Port** – the number of TCP port used for communication between the control panel and computer with DLOADX program via the INT-GSM / INT-GSM LTE module. You can enter a value from 1 to 65535. Default value: 7090.

**DLOADX key** – a string of up to 12 alphanumeric characters (digits, letters and special characters), used for data encryption during communication between the control panel and the computer with DLOADX program via the INT-GSM / INT-GSM LTE module.

## **SATEL server**

The settings below apply to communication with the module via the SATEL server.

**Connection** – select the set of parameters that will be used for establishing communication: INT-GSM ID, INT-GSM IMEI and DLOADX KEY.

**IMEI (INT-GSM)** – you can enter the parameters yourself.

**Module: INT-GSM, Address n** [n=module address] – settings of the INT-GSM / INT-GSM LTE module with the given address will be used.

**INT-GSM ID** – individual identification number assigned to the INT-GSM / INT-GSM LTE module by the SATEL server.

**INT-GSM IMEI** – individual identification number of the GSM telephone of INT-GSM / INT-GSM LTE module.

**DLOADX key** – a string of up to 12 alphanumeric characters (digits, letters and special characters), used for data encryption during communication between the control panel and the computer with DLOADX program via the INT-GSM / INT-GSM LTE module.

### 3.3 Local programming

---

#### 3.3.1 Starting local programming

1. Connect the control panel RS-232 or USB port to the computer port (for the connection method please refer to the INSTALLER MANUAL).

2. Start the DLOADX program and click on the  button. A window will open in which you should select the computer port to which the control panel is connected. Press “OK”.

3. On the LCD keypad connected to the control panel, enter the **service code** (by default 12345) and press the \* key.

4. Using the ▲ or ▼ key, find the DOWNLOADING submenu and press the # or ► key.

5. When the arrow indicates the START DWNL-RS function, press the # or ► key.

 *To start the local programming function you can use the [service code]\*01 key shortcut.*

6. Establishing communication will be signaled on the monitor screen by a corresponding message.

#### 3.3.2 Starting local programming “from pins”

If the control panel does not support LCD keypads, does not accept the service code, etc., you can use the emergency procedure of, so-called, starting “from pins”. The control panel RS-232 port must be connected to the computer (the USB port cannot be used for the emergency starting procedure). In the DLOADX program, indicate the computer port to which the control panel is connected. Then, follow the procedure described in section “Starting the service mode “from pins”” (p. 6).

 *Running the local programming “from pins” is not possible, if the DISABLE DOWNLOADING option is enabled.*

#### 3.3.3 Finishing local programming

To end the local programming you can use the END DWNL-RS function ([service code]\*►DOWNLOADING ►END DWNL-RS).

The local programming function will be finished automatically after 255 minutes have elapsed since the last use of the DLOADX program, and the service access was blocked or expired during that time.

 *The local programming function must be disabled, if the control panel is to communicate through the RS-232 port with an external analog modem, GSM module, INT-GSM / INT-GSM LTE module or ETHM-1 / ETHM-1 Plus module (e.g. during remote programming, event reporting, etc.).*

### 3.4 Remote programming

---

#### 3.4.1 Starting remote programming via modem

The control panel has a built-in 300 bps modem. It can also operate in conjunction with external modems. For information on how to connect the external modem to the control panel please refer to the INSTALLER MANUAL. Initializing the modem connection is possible, if there is a properly matched modem on the computer side (see Table 4).

Configuration on control panel side	Configuration on computer side
Built-in 300 bps modem	Analog modem
External analog modem	Analog modem
	GSM modem
External ISDN modem	ISDN modem
	GSM modem
External GSM modem	Analog modem
	GSM modem

Table 4. Selecting control panel and computer modems.

Communication can be established in several ways (shown in parentheses is information on the required configuration on the control panel side):

1. Connection initialized from the DLOADX program (built-in modem 300 bps or external analog modem). This method makes it possible to establish connection with the control panel from any location. Establishing connection by this method is possible, if the computer telephone number has not been programmed in the control panel.
2. Connection initialized from the DLOADX program, but the control panel calls back and sets up the connection (built-in 300 bps modem or external analog modem). The control panel may only be remotely programmed from a specified locality.
3. Connection initialized by means of SMS (SATEL GSM module operating as an external modem).
4. Connection initialized by the control panel (all configurations). The control panel may only be remotely programmed from a specified locality. It can be applied if the system user prefers that the remote programming cannot be carried out without his knowledge.

**Connection initialized from the DLOADX program**

Control panel settings:

- **do not program the telephone number of modem connected to computer!**
- if an external modem is connected to the control panel, enable the EXTERNAL MODEM option,
- if a GSM or ISDN modem is connected to the control panel, enable the MODEM ISDN/GSM/ETHM option,
- enable the ANSWERING – MODEM option [any modem] or the ANSWERING – ETHM/GSM option [recommended for GSM or ISDN modem],
- define the number of rings after which the control panel will answer incoming calls (RINGS BEFORE ANSWER) [this does not apply to the GSM or ISDN modem],
- enable the DOUBLE CALL option if the control panel is to answer only after the second call [this does not apply to the GSM or ISDN modem].

DLOADX program settings:

- program the telephone number of control panel,
- configure the modem communication parameters.

1. Click on the  button in the DLOADX program.
2. A drop-down menu will be displayed. Select in it the appropriate control panel modem. A window will open in which information on the modem initialization will be displayed.

3. Click on the “Connect” button.
4. The DLOADX program will inform you about establishing connection by means of a suitable message.

### **Connection initialized from the DLOADX program, but the control panel calls back and sets up the connection**

Control panel settings:

- program the telephone number of modem connected to computer,
- if an external modem is connected to the control panel, enable the EXTERNAL MODEM option,
- if a GSM or ISDN modem is connected to the control panel, enable the MODEM ISDN/GSM/ETHM option,
- enable the ANSWERING – MODEM option [any modem] or the ANSWERING – ETHM/GSM option [recommended for GSM or ISDN modem],
- define the number of rings after which the control panel will answer incoming calls (RINGS BEFORE ANSWER) [this does not apply to the GSM or ISDN modem],
- enable the DOUBLE CALL option if the control panel is to answer only after the second call [this does not apply to the GSM or ISDN modem].

DLOADX program settings:

- program the telephone number of control panel,
- configure the modem communication parameters.



1. Click on the  button in the DLOADX program.
2. A drop-down menu will be displayed. Select in it the appropriate control panel modem. A window will open in which information on the modem initialization will be displayed.
3. Click on the “Connect” button.
4. The control panel will answer, confirm answering the connection, hang up, and then call back the programmed computer telephone number.
5. The DLOADX program will answer the connection automatically or the program user must accept establishing the communication (which depends on the settings programmed in the “Configuration” window, “Modem” tab). A suitable message will inform about the connection being established.

### **Connection initiated by SMS message**

Control panel settings:

- program the telephone number of modem connected to computer,
- enable the EXTERNAL MODEM and MODEM ISDN/GSM/ETHM options.

DLOADX program settings:

- configure the modem communication parameters.

Additionally, you need to configure settings of the SATEL GSM module connected to the control panel (see: GSM module manual).



1. Click on the  button in the DLOADX program.
2. A drop-down menu will be displayed. Select the “ISDN/GSM modem” in it. A window will open in which modem initialization information will be displayed.

3. Send to the GSM module connected to the control panel the following SMS message:  
**xxxxxx.** or **xxxxxx=** (“xxxxxx” – the control command programmed in the GSM module, initializing communication with the DLOADX program through modem) – the control panel will call, via the GSM module, the programmed computer telephone number,  
**xxxxxx=yyyy.** or **xxxxxx=yyyy=** (“xxxxxx” – the control command programmed in the GSM module, initializing communication with the DLOADX program through modem; “yyyy” – computer telephone number to which the control panel is to connect) – the control panel will call, via the module, the telephone number sent in the SMS message (the computer telephone number programmed in the control panel will be ignored).
4. The DLOADX program will answer the connection automatically or the program user must accept establishing the communication (which depends on the settings programmed in the “Configuration” window, “Modem” tab). A suitable message will inform about the connection being established.

### Connection initiated by the control panel – built-in modem

Control panel settings:

- program the telephone number of modem connected to computer.

DLOADX program settings:

- configure the modem communication parameters.



1. Click on the  button in the DLOADX program.
2. A drop-down menu will be displayed. Select the “Modem 300 bps” in it. A window will open in which modem initialization information will be displayed.
3. In the LCD keypad connected to the control panel, start the START DWNL-TEL function ([code]\* ► DOWNLOADING ► START DWNL-TEL). The function is available to the installer, administrator and user having the DOWNLOADING STARTING right.
4. The control panel will call the programmed computer telephone number.
5. The DLOADX program will answer the connection automatically or the program user must accept establishing the communication (which depends on the settings programmed in the “Configuration” window, “Modem” tab). A suitable message will inform about the connection being established.

### Connection initiated by the control panel – external modem

Control panel settings:

- program the telephone number of modem connected to computer,
- enable the EXTERNAL MODEM option,
- if a GSM or ISDN modem is connected to the control panel, enable the MODEM ISDN/GSM/ETHM option,

DLOADX program settings:

- configure the modem communication parameters.



1. Click on the  button in the DLOADX program.
2. A drop-down menu will be displayed. Select the “Modem - INTEGRA with ext. modem” in it. A window will open in which modem initialization information will be displayed.
3. In the LCD keypad connected to the control panel, start the START DWNL-MOD function ([code]\* ► DOWNLOADING ► START DWNL-MOD). The function is available to the installer, administrator and user having the DOWNLOADING STARTING right.
4. The control panel will call the programmed computer telephone number.

5. The DLOADX program will answer the connection automatically or the program user must accept establishing the communication (which depends on the settings programmed in the “Configuration” window, “Modem” tab). A suitable message will inform about the connection being established.

### 3.4.2 Starting remote programming via Ethernet network

Programming through the Ethernet network is possible, if the ETHM-1 / ETHM-1 Plus module is connected to the control panel (the RS-232 ports of control panel and module must be connected).



*Before you start the remote programming via Ethernet, make sure that the local programming is finished.*

The connection can be established in one of the following methods:

1. Initiating connection from the DLOADX program. The control panel can be programmed from any location. If communication takes place in a wide area network, the control panel must have a public IP address.
2. Initiating connection from the keypad (by the control panel). The control panel can be programmed only from specified location. This method is recommended when the alarm system owner does not want the remote programming to be carried out without its knowledge. If communication takes place in a wide area network, the computer with DLOADX program must have a public IP address.
3. Initiating connection by SMS message. The computer with DLOADX program must have a public IP address. The INT-GSM / INT-GSM LTE module must be connected to the ETHM-1 Plus module.
4. Establishing connection via the SATEL server. The control panel can be programmed from any location. No public IP address is required for the control panel or the computer with DLOADX program..

Required settings of the control panel for all methods of establishing connection:

- EXTERNAL MODEM, MODEM ISDN/GSM/ETHM and ANSWERING – ETHM/GSM options enabled.

Required settings of the ETHM-1 Plus / ETHM-1 module for all methods of establishing connection:

- COMMUNICATION WITH DLOADX option enabled,
- data encryption key (DLOADX KEY) programmed,
- network settings configured.

### Initiating connection from the DLOADX program

Required settings of the ETHM-1 Plus / ETHM-1 module:

- programmed number of TCP port used for communication.

Required settings of the DLOADX program for direct communication with the module:

- programmed: Ethernet module address (SERVER), number of TCP port used for communication and data encryption key (DLOADX KEY) or selected set of parameters “LAN: ETHM-1, Address n” (settings of the ETHM-1 Plus / ETHM-1 module with address “n” will be used).



*Before initiating the connection, make sure that the suitable connection establishing method is selected in the “Connection settings” window, “Connection” field.*



1. Click on the  button in the DLOADX program.
2. A drop-down menu will be displayed. Click in turn on “TCP/IP: DLOADX -> ETHM” and “LAN/WAN” (WAN connection) or “LAN” (LAN connection).

3. A window will open. Click on the “Connection” button in the window.
4. The DLOADX program will inform you about establishing connection by means of a suitable message.

### Initiating connection from the keypad



*If the INT-GSM / INT-GSM LTE module is connected to the ETHM-1 Plus module and connection over Ethernet cannot be established, an attempt will be made to establish connection via the cellular data network.*

Required settings of the ETHM-1 Plus / ETHM-1 module:

- programmed: address of computer with DLOADX program (SERVER) and number of TCP port used for communication.

Required settings of the DLOADX program for direct communication with the module:

- programmed: number of TCP port used for communication and data encryption key (DLOADX KEY) or selected set of parameters “LAN: ETHM-1, Address n” (settings of the ETHM-1 Plus / ETHM-1 module with address “n” will be used).



1. Click on the  button in the DLOADX program.
2. A drop-down menu will be displayed. Select “TCP/IP: DLOADX <- ETHM/INT-GSM” in it.
3. In the LCD keypad connected to the control panel, start the ETHM-1 →DLOADX function ([code]\* ►DOWNLOADING ►ETHM-1 →DLOADX). The function is available to the installer, administrator and the user having the DOWNLOADING STARTING right.
4. The DLOADX program will inform you about establishing connection by means of a suitable message.

### Initiating connection by SMS message



*The INT-GSM / INT-GSM LTE module must be connected to the ETHM-1 Plus module. If connection via Ethernet cannot be established, an attempt will be made to establish communication via the cellular data network.*

Required settings of the ETHM-1 Plus module:

- programmed: address of computer with DLOADX program (DLOADX SERVER) and number of TCP port used for communication,
- programmed control command, which, if sent in the SMS message, will initiate connection with the DLOADX program.

Required settings of the DLOADX program for direct communication with the module:

- programmed: number of TCP port used for communication and data encryption key (DLOADX KEY).



1. Click on the  button in the DLOADX program.
2. A drop-down menu will be displayed. Select “TCP/IP: DLOADX <- ETHM/INT-GSM” in it.
3. Send to the INT-GSM / INT-GSM LTE module the following SMS message:
  - xxxx=** (“xxxx” – the control command to initiate establishment of communication with DLOADX program) – the module is to connect to the computer address programmed in the module,
  - xxxx=aaaa:p=** (“xxxx” – the control command to initiate establishment of communication with DLOADX program; “aaaa” – address of the computer with DLOADX program (IP address or domain name); “p” – TCP port) – the module is to connect to the computer whose address has been given in the SMS message and use for communication the TCP port given in the SMS message.

- The DLOADX program will inform you about establishing connection by means of a suitable message.

### Establishing connection via the SATEL server



*For communication via the SATEL server, the ports of 1024-65535 range are used as outgoing ports. These ports must not be blocked.*

*If the INT-GSM / INT-GSM LTE module is connected to the ETHM-1 Plus module and connection over Ethernet cannot be established, an attempt will be made to establish connection via the cellular data network.*

Required settings of the ETHM-1 Plus module:

- CONNECTION VIA SATEL SERVER option enabled.

Required settings of the DLOADX program for communication via the SATEL server:

- programmed: identification number assigned to the ETHM-1 Plus module by the SATEL server (ETHM-1 ID), MAC address of the ETHM-1 Plus module (ETHM-1 MAC) and data encryption key (DLOADX KEY) or selected set of parameters “Module: ETHM-1, Address n” (settings of the ETHM-1 Plus module with address “n” will be used).



- Click on the  button in the DLOADX program.
- A drop-down menu will be displayed. Select “TCP/IP: Satel server”.
- A window will open. Click on the “Connection” button in the window.
- The DLOADX program will inform you about establishing connection by means of a suitable message.

### 3.4.3 Starting remote programming via the cellular data network

Programming via the cellular data network is possible if the INT-GSM / INT-GSM LTE module is installed in the alarm system or the SATEL GSM module is connected to the control panel.

#### Programming via the INT-GSM / INT-GSM LTE module

The INT-GSM / INT-GSM LTE module can be connected to the control panel (RS-232 ports of control panel and INT-GSM / INT-GSM LTE module must be connected) or to the ETHM-1 Plus module (RS-232 ports of control panel and ETHM-1 Plus module must be connected).



*If the INT-GSM / INT-GSM LTE module is connected to the ETHM-1 Plus module, cellular data network communication is only used when connection via Ethernet cannot be successfully established.*

GPRS/LTE connection via the INT-GSM / INT-GSM LTE module connected to the control panel can be established in one of the following methods:

- Initiating connection from the keypad (by the control panel). The control panel can be programmed only from specified location. This method is recommended when the alarm system owner does not want the remote programming to be carried out without its knowledge. The computer with DLOADX program must have a public IP address.
- Initiating connection by SMS message. The computer with DLOADX program must have a public IP address.
- Establishing connection via the SATEL server. The control panel can be programmed from any location. No public IP address is required for the computer with DLOADX program.

Required settings of the control panel for all methods of establishing connection:

- EXTERNAL MODEM, MODEM ISDN/GSM/ETHM and ANSWERING – ETHM/GSM options enabled.

Required settings of the INT-GSM / INT-GSM LTE module for all methods of establishing connection:

- COMMUNICATION WITH DLOADX option enabled,
- data encryption key (DLOADX KEY) programmed,
- configured Internet connection settings.

### **Initiating connection from the keypad**

Required settings of the INT-GSM / INT-GSM LTE module:

- programmed: address of computer with DLOADX program (DLOADX SERVER) and number of TCP port used for communication.

Required settings of the DLOADX program for direct communication with the module:

- programmed: number of TCP port used for communication and data encryption key (DLOADX KEY) or selected set of parameters "GSM: INT-GSM, Address n" (settings of the INT-GSM / INT-GSM LTE module with address "n" will be used).



1. Click on the  button in the DLOADX program.
2. A drop-down menu will be displayed. Select "TCP/IP: DLOADX <- ETHM/INT-GSM" in it.
3. In the LCD keypad connected to the control panel, start the INT-GSM → DLOADX function ([code]\* ► DOWNLOADING ► INT-GSM → DLOADX). The function is available to the installer, administrator and the user having the DOWNLOADING STARTING right.
4. The DLOADX program will inform you about establishing connection by means of a suitable message.

### **Initiating connection by SMS message**

Required settings of the INT-GSM / INT-GSM LTE module:

- programmed: address of computer with DLOADX program (DLOADX SERVER) and number of TCP port used for communication,
- programmed control command, which, if sent in the SMS message, will initiate connection with the DLOADX program.

Required settings of the DLOADX program for direct communication with the module:

- programmed: number of TCP port used for communication and data encryption key (DLOADX KEY) or selected set of parameters "GSM: INT-GSM, Address n" (settings of the INT-GSM / INT-GSM LTE module with address "n" will be used).



1. Click on the  button in the DLOADX program.
2. A drop-down menu will be displayed. Select "TCP/IP: DLOADX <- ETHM/INT-GSM" in it.
3. Send to the INT-GSM / INT-GSM LTE module the following SMS message:
  - xxxx=** ("xxxx" – the control command to initiate establishment of communication with DLOADX program) – the module is to connect to the computer address programmed in the module,
  - xxxx=aaaa:p=** ("xxxx" – the control command to initiate establishment of communication with DLOADX program; "aaaa" – address of the computer with DLOADX program (IP address or domain name); "p" – TCP port) – the module is to connect to the computer whose address has been given in the SMS message and use for communication the TCP port given in the SMS message.
4. The DLOADX program will inform you about establishing connection by means of a suitable message.

### **Establishing connection via the SATEL server**



For communication via the SATEL server, the ports of 1024-65535 range are used as outgoing ports. These ports must not be blocked.

Required settings of the INT-GSM / INT-GSM LTE module:

- CONNECTION VIA SATEL SERVER option enabled.

Required settings of the DLOADX program for communication via the SATEL server:

- programmed: identification number assigned to the INT-GSM / INT-GSM LTE module by the SATEL server (INT-GSM ID), IMEI number of the INT-GSM / INT-GSM LTE module (INT-GSM IMEI) and data encryption key (DLOADX KEY) or selected set of parameters "Module: INT-GSM, Address n" (settings of the INT-GSM / INT-GSM LTE module with address "n" will be used).



1. Click on the  button in the DLOADX program.
2. A drop-down menu will be displayed. Select "TCP/IP: Satel server".
3. A window will open. Click on the "Connection" button in the window.
4. The DLOADX program will inform you about establishing connection by means of a suitable message.

### **Programming via the SATEL GSM module**

**GSM-X / GSM-X LTE** module or module with LEON telephone is required:

- GSM LT-1 (firmware version 1.14 or newer),
- GSM LT-2 (firmware version 2.14 or newer),
- GSM-4 (firmware version 4.14 or newer),
- GSM-5 (firmware version 5.14 or newer).

The RS-232 ports of the control panel and GSM module must be connected.

Connection can be established by sending an SMS message to the GSM module. The computer with DLOADX program must have a public IP address.

Required settings of the control panel:

- EXTERNAL MODEM, MODEM ISDN/GSM/ETHM and ANSWERING – ETHM/GSM options enabled.

Required settings of the GSM module:

- programmed: address of the computer with DLOADX program, number of TCP port used for communication, data encryption key and control command which, if sent in the SMS message, will initiate connection with the DLOADX program,
- configured Internet connection settings.

Additionally, you can enable in the module the option that will enable connection to be established with the computer whose network address will be given in the SMS message initiating the connection.

### **Initiating a connection**



1. Click on the  button in the DLOADX program.
2. A drop-down menu will be displayed. Select "TCP/IP: DLOADX <- GSM/GPRS".
3. A window will open. Enter the following information in the corresponding fields:
  - number of the TCP port which is to be used for communication (identical to that programmed in the GSM module, unless communication takes place via a network device redirecting to another port),

- data encryption key (identical to that programmed in the GSM module).
- 4. Having entered the number of TCP port and data encryption key, click the “Start” button. Activation of the server for cellular data network connection will follow.
- 5. Send to the GSM module the following SMS message:
  - zzzzzz.** or **zzzzzz=** (“zzzzzz” – the control command programmed in the GSM module initializing communication via the cellular data network with the DLOADX program) – the GSM module will connect the control panel to the computer whose address is programmed in the module,
  - zzzzzz=aaaa:p.** or **zzzzzz=aaaa:p=** (“zzzzzz” – the control command programmed in the GSM module initializing communication via the cellular data network with the DLOADX program; “aaaa” – address of the computer with DLOADX program (IP address or domain name); “p” – TCP port) – the GSM module will connect the control panel to the computer whose address is given in the SMS message (the computer address programmed in the GSM module will be ignored).
- 6. The DLOADX program will inform you about establishing connection by means of a suitable message.

### 3.5 Control panel data file

---

After readout of the control panel data, you can save the data file to the computer disk. The data file is encrypted. Default encryption prevents the data file from being opened in other location than the disk where the DLOADX program, which was used to save the data, is installed. You can change the default key for data encryption (“File” → “Access setup” → “Data files encryption key”). If you use an encryption key other than the default one, you can open the control panel data file in any location, after entering the encryption key.

You can export the control panel data file (“File” → “Export/Import” → “Export file”). Once the file is exported, it can then be imported from any computer (“File” → “Export/Import” → “Import file”). When exporting the file, you can enter the encryption key which will be required during import of the file.

All the data files can be exported (“File” → “Export/Import” → “Export all”). In this case, you will be required to enter the encryption key.

## 4. System structure

---

The system can be subdivided into objects (subsystems). Partitions are assigned to each object and zones are assigned to partitions.

### 4.1 Objects

---

The objects are treated as separate alarm systems. By default, one object is created in the control panel. New object can be created:

- using the keypad, in the service mode, by means of the NEW OBJECT function (►STRUCTURE ►SYSTEM ►OBJECTS ►NEW OBJECT) – having started the function, select the object to be created (after an object is created, the LCD keypad will automatically display the functions to allow you to assign partitions to objects and to name the objects),
- using the DLOADX program, in the “Structure” window, “System” tab, after clicking on the system name – a new object will be created after you click on the “Add” button.

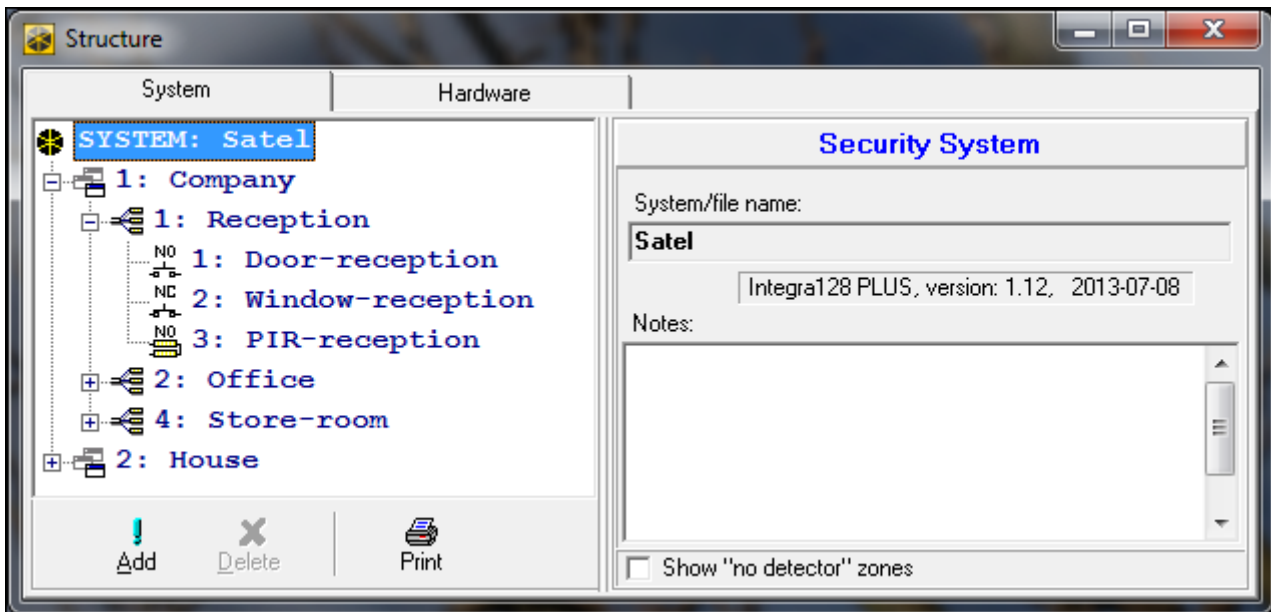

Fig. 2. Presentation of the system structure in the DLOADX program.

## 4.2 Partitions

The partition is a separated area within the premises protected by the security alarm system. The subdivision into partitions enables arming/disarming the system only in part of the protected area, as well as limiting access to some portion of the premises to selected users.

### 4.2.1 Creating partitions

A new partition can be created and, at the same time, assigned to an object:

- using the keypad, in the service mode, by means of the PARTITIONS function (►STRUCTURE ►SYSTEM ►OBJECTS ►EDIT OBJECT ►[select object from list] ►PARTITIONS) – see: “Selection from the multiple-choice list” p. 25,
- using the DLOADX program, in the “Structure” window, “System” tab, after clicking on the object name – a new partition will be created after you click on the “Add” button.

### 4.2.2 Programming partitions

You can program the partitions:

- using the keypad, in the service mode, by means of the functions available in the PARTITIONS submenu (►STRUCTURE ►SYSTEM ►PARTITIONS),
- using the DLOADX program, in the “Structure” window, “System” tab, after clicking on the partition name.

### 4.2.3 Partition parameters

Shown in square brackets is the parameter name as presented in the LCD keypad.



*The user authentication can be based on a code, proximity card (125 kHz passive transponder) or DALLAS iButton. In the description of the partition parameters only the codes are taken into account, but the information also applies to the proximity cards and DALLAS iButtons.*

**Partition name** – individual name of partition (up to 16 characters).

**Partition 1**

Partition name:

Belongs to object:

Type  
Partition type:

Options

Arm by two codes

Disarm by two codes

Codes on two keypads

Valid within 30 sec.

Timer priority

Exit delay clearing

Default block time

Alarm-disarm allowed

Timers

Partition timer

Times

Infinite exit delay

Partition exit delay:  sec.

Auto-arming delay:  sec.

Alarm verification time:  min.  sec.

Audible alarm after verification

Guard round (on armed) every:  min.

Guard round (on disarmed) every:  min.

Blocked for guard round:  min.  sec.

Cash machine block delay:  min.  sec.

Cash machine block time:  min.  sec.

Show "no detector" zones

Fig. 3. Example of partition settings in the DLOADX program.

## Partition type

**Armed with code** [Normal] – the partition can be armed/disarmed by the user.

**With temporary blocking** [With time bypass] – the partition can be armed/disarmed by the user, but on arming the partition is blocked for a time indicated by the user or determined by the installer (see DEFAULT BLOCK TIME option). When blocked, the partition can only be disarmed by the user having the ACCESS TO TEMPORARY BLOCKED PARTITIONS right. An alarm can end the blocking (see ALARM – DISARM ALLOWED option).

**Follow type “AND”** [Dependent “AND”] – the partition controlled by status of other partitions. You should indicate the partitions whose status affects the dependent partition. The dependent “AND” type of partition will be armed when all indicated partitions are armed (start of the procedure of arming the last of the indicated partitions will initiate the procedure of arming the dependent partition). The dependent “AND” type of partition will be disarmed when any of the indicated partitions is disarmed. This type of partition is recommended in case of shared corridors.

**Follow type “OR”** [Dependent “OR”] – the partition controlled by status of other partitions. You should indicate the partitions whose status affects the dependent partition. The dependent “OR” type of partition will be armed when any of the indicated partitions is

armed (start of the procedure of arming any of the indicated partitions will initiate the procedure of arming the dependent partition). The dependent “OR” type of partition will be disarmed when all indicated partitions are disarmed.

**Access according to timer 1...32** [Acc. by t. 1..32] / **Access according to timer 33...64** [Acc. by t.33..64] – the partition can be armed/disarmed by the user, but only within the time intervals set by the indicated timers.

**Controlled by timer 1...32** [Tim. 1..32 ctrl] / **Controlled by timer 33...64** [Tim. 33..64 ctrl] – the partition, which is armed in time periods determined by selected timers, but may also be controlled by the user code.

**Bank vault** – the partition can be armed / disarmed by the user. Disarming may be delayed by a defined period of time (see: DISARM DELAY). After it has been disarmed, the partition can be automatically re-armed after a defined period of time elapses (see: TIME TO RE-ARM).

## Times

**Partition exit delay** – the time counted from the start of the procedure of arming (by the user, timer, zone, etc.), which allows to leave the protected area without triggering an alarm.

**Auto-arming delay** [Auto-arm delay] – the time counted before starting the procedure of arming by timer. It allows the user to postpone or cancel the auto-arming.

**Alarm verification time** [Al. verify time] – the time counted from the triggering alarm by a zone included in alarm verification (with enabled PRE-ALARM or WITH VERIFICATION option). If during the count another zone included in the alarm verification triggers an alarm, a verified alarm will be triggered.

**Guard round (on armed) every** [Guard - armed] – the maximum period of time that can elapse since the last guard round when the partition is armed. If the time is exceeded, information about the lack of guard round will be saved to the control panel memory. Programming the value 0 will disable the control of guard round.

**Guard round (on disarmed) every** [Guard - disarm.] – the maximum period of time that can elapse since the last guard round when the partition is disarmed. If the time is exceeded, information about the lack of guard round will be saved to the control panel memory. Programming the value 0 will disable the control of guard round.

**Blocked for guard round** [Time for guard] – the time counted from the moment of registering the guard round, during which the partition is blocked.

**Cash machine block delay** [C.mach.blk.del.] – the time counted from the moment of entering the user code of the CASH MACHINE ZONES BYPASSING type. After expiry of this time, the 24H CASH MACHINE type zones will be bypassed.

**Cash machine block time** [C.mach.blk.time] – the time during which the 24H CASH MACHINE type zones will be bypassed after entering the user code of the CASH MACHINE ZONES BYPASSING type. The bypass can be delayed by the CASH MACHINE BLOCK DELAY.

**Disarm delay** – the parameter applies to the BANK VAULT partition type. The partition will only be disarmed after a defined period of time has elapsed since the code was used by the user. If the time is equal to 0, the partition will be disarmed immediately.

**Time to re-arm** – the parameter applies to the BANK VAULT partition type. After disarming, the control panel will be analyzing for a defined period of time whether a door in the partition will be opened by means of an access control module (partition keypad, code lock, etc.). If the door is not opened, the partition will be automatically re-armed (the partition exit delay countdown will not be running). If the time value is equal to 0, the partition will not be re-armed. Irrespective of the preset value, if the DISARM DELAY parameter is 0, the partition will not be re-armed.

## Options

**Arm by two codes** [2 cds to arm] – if this option is enabled, arming requires that codes be entered in turn by two users.

**Disarm by two codes** [2 cds to d-arm] – if this option is enabled, disarming requires that codes be entered in turn by two users.

**Codes on two keypads** [Codes on 2 kpd] – if this option is enabled and the partition is armed/disarmed using two codes, they must be entered from different keypads.

**Valid within 30 sec** [1st code 30s] – if this option is enabled and two codes are required for arming/disarming, the second user has to enter the code within 30 seconds of entering the code by the first user.

**Timer priority** – if this option is enabled, arming/disarming is always done by the timer. If this option is disabled, the timer will disarm the partition if it was armed by the timer (if it was armed by the user, the timer will not disarm the partition).

**Infinite exit delay** [Infin.ex.delay] – if this option is enabled, the partition will be armed after entering the code and then:

- violating the 86. ENTRY/EXIT – FINAL, 87. EXIT – FINAL or 89. FINISHING EXIT DELAY type zone,
- shortening of the exit delay time by the user (see EXIT DELAY CLEARING option).

If partition is not armed within 260 seconds, the “Arming failed” event will be registered to the control panel memory. With the option enabled, the PARTITION EXIT DELAY will be taken into account, if the partition is armed using a zone or timer.

**Exit delay clearing** [Fin.exit delay] – if this option is enabled, you can reduce the exit delay countdown by entering 9# from the keypad/partition keypad. The partition will be armed immediately. The exit delay clearing is only available from the same keypad/partition keypad, from which the partition was armed (the EXIT DELAY CLEARING ENABLE option must be enabled in the keypad).

**Default block time** – the option applies to the WITH TEMPORARY BLOCKING partition type. If the option is enabled and the DEFAULT PART. BLOCK TIME is preset, the partition will be blocked on arming for a default time period, as defined by the installer (the blocking time cannot be programmed by the user).

**Alarm – disarm allowed** – the option applies to the WITH TEMPORARY BLOCK partition type. During alarm, the partition can be disarmed by the users who do not have the ACCESS TO TEMPORARY BLOCKED PARTITIONS right.

**Audible alarm after verification** [Bell on 2nd] – if this option is enabled, the alarms from zones with the PRE-ALARM or WITH VERIFICATION option enabled will only trigger loud alarm signaling after verification. The unverified alarms will not trigger loud alarm signaling.

## Partition timer

Partitions can be controlled with an additional timer, which can be programmed:

- in the keypad, using the function available in the user menu ([code]\* ►OPTIONS PROGRAMMING ►PARTITION TIMERS),
- in the DLOADX program **connected to the control panel**, in the “Structure” window, “System” tab, after clicking on the partition name and then on the “Partition timer” button.

## 4.3 Zones

---

The zone is a separated portion of the protected area which can be supervised by a detector or detectors. A zone can only be assigned to one partition.

The system supports the following zones:

- **hardwired** – on the control panel electronics board, in keypads and expanders. The number of available hardwired zones is determined by the control panel during identification procedure.
- **wireless** – when the ABAX 2 / ABAX wireless system controller is connected. The number of available wireless zones depends on the number of wireless devices registered in the system and is determined during the procedure of adding the devices.
- **virtual** – zones which physically do not exist, but have been programmed as FOLLOW OUTPUT or are controlled by means of a keyfob.

#### 4.3.1 Assigning zones to a partition

The zones can be assigned to a partition:

- using the keypad, in the service mode, by means of the ZONES function (►STRUCTURE ►SYSTEM ►PARTITIONS ►SETTINGS ►[Part. Name] ►ZONES) – see: “Selection from the multiple-choice list” p. 25,
- using the DLOADX program:
  1. in the “Structure” window, “System” tab, after clicking on the partition name. Click on the “Add” button to display the list of zones which can be assigned to the selected partition. Click on the zone which is to be assigned to the partition.
  2. in the “Zones” window, “Zones” tab, “Part.” column, enter the number of partition to which the given zone is to be assigned.

#### 4.3.2 Programming the EOL resistor values

As regards the zones on the control panel mainboard, in some keypads and expanders, the value of end-of-line resistors is programmable within the range from 500  $\Omega$  to 15 k $\Omega$  (the sum of preset values may not exceed 15 k $\Omega$ ).

The value of EOL resistors for the zones on mainboard can be programmed:

- using the keypad, in the service mode, by means of EOL R1 RESISTOR, EOL R2 RESISTOR and EOL R3 RESISTOR functions (►STRUCTURE ►HARDWARE ►EOL R1 RESISTOR / ►EOL R2 RESISTOR / ►EOL R3 RESISTOR),
- using the DLOADX program, in the “Structure” window, “Hardware” tab, after clicking on the control panel mainboard.



*The value of EOL resistors programmed for the mainboard zones applies also to the zones in the keypads:*

- INT-KLCD and INT-KLCDR with electronics version 3.2 and firmware version 2.11 (or later),
- INT-KLFR,
- INT-KSG with firmware version 1.02 (or later),
- INT-TSG,
- INT-TSG2,
- INT-TSH,
- INT-TSH2,
- INT-TSI.

The value of EOL resistors for the zones in expanders can be programmed:

- using the keypad, in the service mode, by means of EOL R1 RESISTOR, EOL R2 RESISTOR and EOL R3 RESISTOR functions (►STRUCTURE ►HARDWARE ►EXPANDERS ►SETTINGS ►[expander name] ►EOL R1 RESISTOR / ►EOL R2 RESISTOR / ►EOL R3 RESISTOR),

- using the DLOADX program, in the “Structure” window, “Hardware” tab, after clicking on the given expander.

For the zones in INT-KSG keypad with firmware 1.00 or 1.01, the value of EOL resistors is programmed in the DLOADX program, “Structure” window, “Hardware” tab. After clicking on the given keypad, select the corresponding tab. The value of these resistors cannot be programmed from the keypad.



*The recommended version of INT-KSG keypad firmware is 1.02 (or later).*

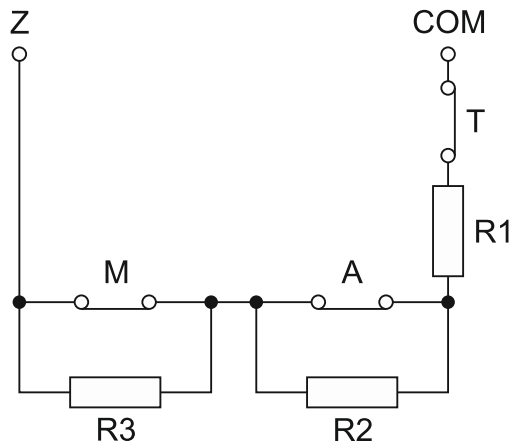

Fig. 4. Numeration of EOL resistors. T – tamper. A – alarm. M – masking. In case of the EOL and 2EOL configurations, the R3 resistor value is irrelevant. In case of the EOL configuration, the resistor value is a sum of the values programmed for the R1 and R2 resistors.

### 4.3.3 Programming the zones

The zones can be programmed:

- using the keypad, in the service mode, by means of the functions available in the ZONES submenu,
- using the DLOADX program:
  1. in the “Structure” window, “System” tab, after clicking on the selected zone,
  2. in the “Zones” window.

### 4.3.4 Zone parameters

**Zone name** – individual name of the zone (up to 16 characters).

**Assigned to** – partition to which the zone belongs.

**Zone type** (see: “Zone types” p. 51).

**Entry delay** – refers to the delayed zones (including the zone types: 0. ENTRY/EXIT, 1. ENTRY, 2. DELAYED, 3. INTERIOR DELAYED, 85. ENTRY/EXIT – CONDITIONAL, 86. ENTRY/EXIT – FINAL, 94. ENTRY/EXIT INTERIOR and 95. ENTRY INTERIOR). The alarm from the zone will be delayed by a preset time. This makes it possible to disarm the partition before the alarm is triggered.

**Signaling delay** – refers to the 4. PERIMETER, 5. INSTANT and 6. EXIT type zones. Loud alarm signaling can be delayed by a programmed time period.

**Alarm delay** – refers to the 5. INSTANT and 6. EXIT type zones. The alarm from zone may be delayed by a programmed time period.

**Surveillance time** – refers to the 8. EXTERIOR type zones.

**Bypass time** – refers to the bypassing zones (zone types 64-79). It indicates for how long the zones will be bypassed. If value 0 is programmed, the zones will remain bypassed until disarming the partitions to which they belong, or until they are unbypassed by the user.

Zone 1 - Module: Main Board.

Zone name: Door-reception      Wiring type: 1: NC

Assigned to: 1: Reception      Zone sensitivity: 320 ms.

Zone type: 0: Entry/Exit      Max. violation time: 0 sec.

Entry delay: 30 sec.      Max. no viol. time: 0 min.

Comments:

Options

<input type="checkbox"/> Power Up Delay	<input type="checkbox"/> Auto-reset 3	<input checked="" type="checkbox"/> Abort delay
<input type="checkbox"/> Priority	<input type="checkbox"/> Auto-reset 1	<input type="checkbox"/> Restore after bell
<input type="checkbox"/> Video on disarmed	<input type="checkbox"/> Clearing Autoreset	<input type="checkbox"/> Restore after disarm
<input type="checkbox"/> Video on armed	<input type="checkbox"/> With verification	<input checked="" type="checkbox"/> Alarm on Exit delay end
<input type="checkbox"/> Bypass disabled	<input type="checkbox"/> Bell delay	<input checked="" type="checkbox"/> Alarm on unbypass
<input type="checkbox"/> Bypassed if no exit	<input type="checkbox"/> Blocks verification	<input checked="" type="checkbox"/> Tamper alarm always loud
		<input checked="" type="checkbox"/> CHIME in module

Previous zone      OK      Next zone

Fig. 5. Example of zone settings in the DLOADX program.

**Module number (lock/keypad)** – refers to the 58. TECHNICAL – DOOR BUTTON type zones. It defines which door will be unlocked after zone violation (you can indicate a door controlled by partition keypad, code lock, proximity card reader expander or DALLAS chip reader expander).

**Arming mode** – refers to the 80. ARMING and 82. ARM/DISARM type zones. It defines which type of armed mode will be activated by the zone:

0 – full armed mode,

1 – fully armed and, additionally, the zones for which the BYPASSED IF NO EXIT option is enabled, will be bypassed,

2- 3. INTERIOR DELAYED type zones will not be armed, 8. EXTERIOR will trigger silent alarm, and the other ones – audible alarm,

3 – same as 2, but the delayed zones type will act as instant ones.

**Group** – refers to the 80. ARMING, 81. DISARMING, 82. ARM/DISARM and 83. CLEARING ALARM type zones. It defines which group of partitions will be controlled by the zone (the zone always controls the partition it belongs to). If value 0 is programmed, the zone will only control the partition to which it belongs.

**Exit delay** – refers to the 89. FINISHING EXIT DELAY type zones.

**Outputs group** – refers to the 92. OUTPUTS GROUP OFF type zones.

**Wiring type** – must be selected to match the detector type and how it is connected to the zone:

**0. no detector** – no detector is connected to the zone,

**1. NC** – the zone supports a detector of NC (normally closed) type,

**2. NO** – the zone supports a detector of NO (normally open) type,

**3. EOL** – the zone supports a detector of NO or NC type with EOL resistor in the circuit,

**4. 2EOL/NC** – the zone supports a detector of NC type with two EOL resistors in the circuit,

**5. 2EOL/NO** – the zone supports a detector of NO type with two EOL resistors in the circuit,

- 6. **Roller** – the zone supports a roller shutter detector,
- 7. **Vibration** – the zone supports a shock detector (also NC type detector),
- 8. **Follow output** – the zone does not support any detectors – its status depends solely on the status of selected output (physical violations and tampers of the zone are ignored),
- 9. **Roller 2EOL** – the zone supports a roller shutter detector with two EOL resistors in the circuit,
- 10. **Vibration 2EOL** – the zone supports a shock detector (also NC type detector) with two EOL resistors in the circuit,
- 11. **3EOL/NC** – the zone supports a detector of NC type with three EOL resistors in the circuit,
- 12. **3EOL/NO** – the zone supports a detector of NO type with three EOL resistors in the circuit.

**Zone sensitivity** – depending on wiring type:

**NO, NC, EOL, 2EOL/NC, 2EOL/NO, 3EOL/NC and 3EOL/NO** – the time during which the zone must be violated, so that it can be noted by the control panel.

**Roller / Roller 2EOL** – 2 parameters are to be programmed (in the DLOADX program, you should enter two numbers in the ZONE SENSITIVITY field):

**Pulses duration** – the time period during which a specified number of pulses must occur (PULSES COUNT) for the zone to be violated. You can enter 0 (the pulse counter will only be reset on arming / disarming), 1 (30 seconds), 2 (120 seconds) or 3 (240 seconds).

**Pulses count** – the number of pulses after which the zone will be violated. You can program values from 1 to 8.

**Vibration / Vibration 2EOL** – 2 parameters are to be programmed (in the DLOADX program, you should enter two numbers in the ZONE SENSITIVITY field):

**Sensitivity** – occurrence of a shock whose duration is equal to or longer than the defined time will cause violation of the zone. You can program values from the 3 ms to 96 ms range (every 3 ms).

**Pulses count** – the number of shocks after which the zone will be violated. You can program values from 0 to 7. If the value 0 is programmed, the pulses (shocks) will not be counted – only SENSITIVITY will be taken into account.

**Output** – refers to the FOLLOW OUTPUT wiring type. Indicate the number of output whose activation will violate the zone. The output can be a virtual one.

**Max. violation time / Max. door opening time** – exceeding the maximum time of violation/door opening is recognized by the control panel as a detector failure/door failure. If the value 0 is programmed, control of this time is disabled.

**Max. no violation time** – exceeding the maximum time of no violation is recognized by the control panel as a detector failure. The time will only be counted when the zone is disarmed. If the value 0 is programmed, control of this time is disabled. The time can be programmed in hours or minutes.



*It is recommended that you program the MAX. NO VIOLATION TIME parameter, since it will provide an additional supervision of the detector connected to the zone.*

#### 4.3.5 Zone types

**0. ENTRY/EXIT** – a delayed zone combining two functions:

entry – violation of the zone starts entry delay counting in the partition and turns on delay for the 3. INTERIOR DELAYED type zones,

exit – violation of the zone during exit delay countdown is equivalent to the partition exit.

1. **ENTRY** – violation of the zone starts entry delay counting in the partition and turns on delay for the 3. INTERIOR DELAYED type zones.
2. **DELAYED** – a delayed-action zone with optional signaling of delay countdown in keypads.
3. **INTERIOR DELAYED** – the zone operates as a delayed one when:
  - violation of another zone has triggered the entry delay countdown in the partition,
  - the delay will be activated using the INT-ENT entry keypad (see the INT-SCR multifunction keypad manual),
  - arm mode type 2 or 3 is active and the DELAY IN 2&3 TYPE ARMING option is enabled for the zone.

In other situations, the zone will act as an instant one.

4. **PERIMETER** – instant zone, which is already armed during exit delay countdown.
5. **INSTANT** – instant zone.
6. **EXIT** – violation of the zone during exit delay countdown is equivalent to the partition exit.
7. **DAY/NIGHT** – if disarmed, the zone will signal violation acoustically in keypads and on the 9. DAY ALARM, 12. SILENT ALARM and 116. INTERNAL SIREN outputs. When armed, the zone acts as the 5. INSTANT zone.
8. **EXTERIOR** – a zone with alarm verification: zone violation will start counting the surveillance time – if a second violation takes place during this time, an alarm will be triggered. If the SURVEILLANCE TIME is not programmed (the value 0 is entered), the alarm will be generated upon the first violation.
9. **24H TAMPER** – permanently armed zone, intended for the tamper circuits. The zone violation will additionally cause a trouble condition.
10. **24H VIBRATION** – permanently armed zone, intended for working with vibration detectors.



*If the partition includes the 10. 24H VIBRATION zone, starting the procedure of arming from the LCD keypad will initiate a test of vibration detectors (the 39. TEST VIBRATION DETECTORS output is activated and the countdown of time remained to the test end is running).*

11. **24H CASH MACHINE** – permanently armed zone, intended for protection of a cash machine.
12. **PANIC-AUDIBLE** – permanently armed zone, intended for operating the panic buttons.
13. **PANIC-SILENT** – permanently armed zone, intended for operating the panic buttons. Violating the zone will trigger a silent alarm.

#### 14. **MEDICAL – BUTTON**

#### 15. **PERSONAL EMERGENCY**

The zone types 14 and 15 trigger alarm signaled in the LCD keypads and on the 12. SILENT ALARM outputs. The names of zones and codes of events from these zones are consistent with the Contact ID reporting format.

- 16...31 **COUNTING C1...16** – the counting zones will signal an alarm when the number of violations counted during a specified time period exceeds the set value (see: “Counters” p. 57). Violations of the counting zones in armed mode can be signaled at the 9. DAY ALARM, 12. SILENT ALARM and 116. INTERNAL SIREN outputs.

#### 32. **24H FIRE**

#### 33. **24H FIRE – SMOKE**

#### 34. **24H FIRE – COMBUSTION**

#### 35. **24H FIRE – WATER FLOW (FIRE)**

#### 36. **24H FIRE – HEAT**

#### 37. **24H FIRE – PULL STATION**

#### 38. **24H FIRE – DUCT**

**39. 24H FIRE – FLAME**

The zone types from 32 to 39 cause a fire alarm. The names of zones and codes of events from these zones are consistent with the Contact ID reporting format. The fire zones (except for 24H FIRE – BUTTON) can work with alarm verification.

**40. 24H FIRE SUPERVISORY****41. 24H LOW WATER PRESSURE****42. 24H LOW CO2****43. 24H WATER VALVE DETECTOR****44. 24H LOW WATER LEVEL****45. 24H PUMP ACTIVATED****46. 24H PUMP FAILURE**

**47. NO ALARM ACTION** – may be used to control the outputs. Additional options (STORE TO EVENT LOG, NO REPORTING and STORE EVENT ONLY IF ARMED) enable the zone to be used for other applications e.g. supervising the keybox.

**48. 24H AUXILIARY – PROTECTION LOOP****49. 24H AUXILIARY – GAS DETECTOR****50. 24H AUXILIARY – REFRIGERATION****51. 24H AUXILIARY – LOSS OF HEAT****52. 24H AUXILIARY – WATER LEAKAGE****53. 24H AUXILIARY – FOIL BREAK****54. 24H AUXILIARY – LOW BOTTLED GAS LEVEL****55. 24H AUXILIARY – HIGH TEMPERATURE****56. 24H AUXILIARY – LOW TEMPERATURE**

**57. TECHNICAL – DOOR OPEN** – zone intended for supervising the status of the door defined as DEPENDENT DOOR in the module executing the access control functions (partition keypad, code lock, readers expander).

**58. TECHNICAL – DOOR BUTTON** – zone violation will result in opening the door controlled by the module executing the access control functions (partition keypad, code lock, readers expander).

**59. TECHNICAL – AC LOSS** – intended for control of devices working together with the alarm control panel e.g. additional power supply units. Violation of the zone will cause a trouble condition.

**60. TECHNICAL – BATTERY LOW** – intended for control of the batteries of additional power supply units working in conjunction with the control panel. Violation of the zone will cause a trouble condition.

**61. TECHNICAL – GSM LINK TROUBLE** – intended for control of the external GSM communication module. Violation of the zone will cause a trouble condition.

**62. TECHNICAL – OVERLOAD** – intended for control of an additional power supply unit used together with the control unit. Violation of the zone will cause a trouble condition.

**63. TROUBLE** – violation of the zone will cause a trouble condition.

**64...79 BYPASSING – GROUP: 1–16** – violation of this type of zone can bypass a group of zones (see: “Bypasses” p. 57).

**80. ARMING** – violation of the zone will arm the partition to which the zone belongs. Additionally, you can select a group of partitions which will also be armed (see: “Groups of partitions” p. 58).

- 81. DISARMING** – violation of the zone will disarm the partition to which the zone belongs. Additionally, you can select a group of partitions which will also be disarmed (see: “Groups of partitions” p. 58).
- 82. ARM/DISARM** – the zone controls the arming status of the partition it belongs to. Additionally, the zone can control a group of partitions (see: “Groups of partitions” p. 58). The control mode depends on the CONTR. BY PULSE(OFF-BY STATE) option. Disarming may simultaneously clear the alarm and cancel the messaging.
- 83. CLEARING ALARM** – violation of the zone will clear alarm in the selected group of partitions (see: “Groups of partitions” p. 58) or the partition to which the zone belongs, and can also cancel messaging.
- 84. GUARD** – violation of the zone is recognized as recording the guard's round in the partition to which the zone belongs.
- 85. ENTRY/EXIT – CONDITIONAL** – similarly as the 0. ENTRY/EXIT type with an extra feature: the zone becomes an instant one upon arming, if no partition exit is registered upon starting the arming procedure.
- 86. ENTRY/EXIT – FINAL** – similarly as the 0. ENTRY/EXIT, but the zone restore during exit delay countdown will terminate the exit delay countdown and arm the system.
- 87. EXIT – FINAL** – similarly as the 6. EXIT, but the zone restore during exit delay countdown will terminate the exit delay countdown and arm the system.
- 88. 24H BURGLARY** – a permanently armed zone. Its violation will cause the burglary alarm.
- 89. FINISHING EXIT DELAY** – zone violation will reduce the partition exit delay time. It is possible to program a shorter exit delay time. If this value remains not programmed, the exit delay will be reduced to 4 seconds from the zone violation. There will be no effect if the zone is violated and the just running exit delay is shorter than that programmed for the zone.
- 90. DISABLING VERIFICATION** – zone violation will disable verification of alarms in the partition. All alarms will be unverified until next arming.
- 91. DETECTOR MASK** – the permanently armed zone, dedicated to anti-masking control. Violation of the zone will be treated by the control panel as detector trouble (masking).
- 92. OUTPUTS GROUP OFF** – the zone allows to deactivate a selected group of outputs.
- 93. OUTPUTS GROUP ON** – the zone allows to activate a selected group of outputs.
- 94. ENTRY/EXIT INTERIOR** – similarly as the 0. ENTRY/EXIT, but it will only be armed in the case of full armed status (arming modes 0 and 1).
- 95. ENTRY INTERIOR** – similarly as the 1. ENTRY, but it will only be armed in the case of full armed status (arming modes 0 and 1).
- 96. FIRE MONITORING** – permanently armed zone. After the zone is violated, fire alarm information is saved to the control panel memory.
- 97. FIRE PANEL FAULT. MONIT.** – permanently armed zone. After the zone is violated, an event is saved to the control panel memory.

#### 4.3.6 Zone options

- Power up delay** – when the option is enabled, the zone will be bypassed for 120 sec. after power-up (which prevents triggering alarms e.g. when starting the alarm control panel).
- Priority** – when this option is enabled, arming will be impossible, if the zone is violated (e.g. windows have been left open, etc.).
- Contr. by pulse(off-by state)** – option for 82. ARM/DISARM zone type. If it is enabled, violation of the zone will arm/disarm the partition (depending on the current status of the partition). If the option is disabled, zone violation will arm, and the zone restore will disarm the partition.

**CHIME in module** – with this option enabled, zone violation can be signaled in partition keypads, code locks and readers expanders assigned to the same partition as the zone (the option CHIME must be enabled in the expander).

**No alarm sign. in keypad** – option for 13. PANIC-SILENT zone type. If it is enabled, alarm from this zone will not be signaled on keypads. Clearing this alarm by means of keypad will not be possible.



*Outputs signaling the silent panic alarm can be deactivated using the CLEAR LATCHED OUTPUTS user function.*

**Video on disarmed** – if this option is enabled, violating the zone when the partition is disarmed will activate the 15. VIDEO ON DISARMED type output.

**Video on armed** – if this option is enabled, violating the zone when the partition is armed will activate the 16. VIDEO ON ARMED type output.

**Bypass disabled** – if this option is enabled, the user cannot bypass the zone.

**Bypassed if no exit** – if this option is enabled, the zone will be automatically bypassed, when no partition exit is registered during the partition exit delay countdown. The zone will also be bypassed when the “full + bypasses” arming mode is on (registering a partition exit is irrelevant then). The zone will be unbypassed after the partition is disarmed.

**Alarm in arm state** – an option for the zone types 64-79. It is available, if the NO BYPASS IF ARMED option is enabled. When it is enabled, violating an armed zone will cause an alarm (if the partition exit was registered upon arming).

**Alarming** – option available for the 91. DETECTOR MASK zone type. If enabled, violation of the zone will additionally trigger an alarm.

**Auto-reset 3** – with this option enabled, the zone can trigger up to 3 alarms. As long as the alarm is not cleared or the partition is not armed/disarmed, violations of the zone will not trigger any alarm.

**Auto-reset 1** – with this option enabled, the zone can trigger only 1 alarm. As long as the alarm is not cleared or the partition is not armed/disarmed, violations of the zone will not trigger any alarm.

**Clearing Autoreset** – with this option enabled, alarm counters for the zones for which the AUTO-RESET 3 or AUTO-RESET 1 option is enabled can be automatically reset at midnight (violations of these zones will be able to trigger alarms again).

**Pre-alarm** – if this option is enabled, alarms from the zone will be verified.

**With verification** – an option for the zone types 0-2, 85-86 and 94-95. If it is enabled, alarms from the zone will be verified.



*Alarm from the zone with enabled PRE-ALARM or WITH VERIFICATION option will be an unverified alarm, unless during verification (see description of the ALARM VERIFICATION TIME parameter p. 46) an alarm will be caused by another zone with enabled PRE-ALARM or WITH VERIFICATION option. In such a case, a verified alarm will be triggered.*

**Bell delay** – an option for the zone types 5 and 6. It changes the way of reaction to a zone violation when armed. If the option is disabled, the alarm from zone will be delayed by a programmed time period (ALARM DELAY). If the option is enabled, the zone will alarm immediately (event, reporting and telephone messaging), but the loud signaling will be delayed by a programmed time period (SIGNALING DELAY).

**Delay in 2&3 type arming** – an option for the 3. INTERIOR DELAYED zone type. If the option is enabled, the zone will be armed and act as a delayed one upon activation of the type 2 (without interior) and type 3 (without interior and without entry delay) arm mode.

**Alarm clearing** – an option for the zone types 81 and 82. With this option enabled, violation of the zone will clear alarm in the partition, if it is currently indicated.

**Abort delay** – when this option is enabled, violating the zone during the entry delay countdown will result in registering a “Zone violation” event (this event can only be reported in the 4/2 format). When the option is disabled, violating the zone during the entry delay countdown will result in registering an “Alarm” event (this event is reported and initiates messaging).

**Report if not armed** – option for the 7. DAY/NIGHT zone type. If it is enabled, the alarm will be reported at all times. If it is disabled, the alarm will only be reported if the zone is armed. If the zone is disarmed, the zone violation will trigger a warning alarm. The warning alarm does not cause any loud alarm signal and is not reported. It can be signaled by the 9. DAY ALARM, 12. SILENT ALARM and 116. INTERNAL SIREN type outputs.

**Event: arming failed** [Event arm fail] – option for 80. ARMING and 82. ARM/DISARM zone types. If this option is enabled, unsuccessful arming by means of zone is saved to the event log.

**Partition temporary blocking** – option for the 84. GUARD zone type. If it is enabled, violation of the zone will block the partition for the time of guard round.

**Restore after bell** – with this option enabled, the zone restore code will be reported to the central monitoring station only after the alarm signaling is ended.

**Restore after disarm** – with this option enabled, the zone restore code will be reported to the central monitoring station only after disarming the partition to which the zone belongs.

**Alarm on exit delay end** – with this option enabled, the zone will trigger alarm if it is violated at the moment of ending the exit delay countdown. If the option is disabled, the alarm will only be triggered in case of changing the zone status from normal to violated when armed.

**Store to event log** – option for the 47. NO ALARM ACTION and 63. TROUBLE zone types. If it is enabled, violation of the zone will result in storing an event according to the zone type (in case of the 47. NO ALARM ACTION zone type, the information to be written depends additionally on the NO REPORTING option).

**No reporting** – option for the 47. NO ALARM ACTION zone type with the STORE TO EVENT LOG option enabled:

- enabled – violation of the zone will write an event informing about zone violation,
- disabled – violation of the zone will result in writing an event informing about keybox opening, the code of which is sent to the monitoring station.

**No restore event** – option for the 47. NO ALARM ACTION zone type with STORE TO EVENT LOG and NO REPORTING options enabled. If it is enabled, the zone restore is not stored into the event log.

**Store event only if armed** – option for the 47. NO ALARM ACTION zone type. It is available, if the STORE TO EVENT LOG option is enabled. If it is enabled, violations of the zone will be written into the event log, provided that the partition to which the zone is assigned, is armed.

**No bypass if armed** – option for the 64-79 zone types. If it is enabled, violation of the armed zone will block no group of zones (provided that during the exit delay countdown an exit from the partition is recorded).

**Messaging cancelling** – option for the 81-83 zone types. If it is enabled, violation of the zone will cancel the messaging, if it is currently ongoing.

**Alarm on unbypass** – if the option is enabled and the armed zone is violated after being bypassed, an alarm will be triggered.

**Tamper alarm always loud** – if this option is enabled, tamper alarm is always loud (if option is disabled – tamper alarm is loud only when armed).

**Reporting delay** – option for the 4-8 and 64-79 zone types. Violation of the zone during the entry delay countdown will trigger a warning alarm. The warning alarm does not cause any loud alarm signal and is not reported. It can be signaled by the outputs of 9. DAY ALARM,

12. SILENT ALARM and 116. INTERNAL SIREN type. If the zone is not disarmed within 30 seconds, the entry delay has expired or another instant is violated, the burglary alarm will be triggered.

**Blocks verification** – option for 0-2, 85-86 and 94-95 zone types. If it is enabled, violation of the zone will block verification of alarms in the partition. All alarms will be unverified until the partition is armed again.

**Check arm possibility** – option for the arming zones (80 and 82 zone types). The zone will not arm, if a zone with enabled PRIORITY option is violated in the partition, or other circumstance have occurred which prevent arming (depending on the selected options, tamper, trouble, etc.).

**Restore disarms** – option for the 89. FINISHING EXIT DELAY zone type. If it is enabled, the zone restore will disarm the partition. This option overrides the option RESTORE DISABLES VERIF.

**Restore disables verif.** – option for the 89. FINISHING EXIT DELAY zone type. If it is enabled, the zone restore will disable verification of alarms in the partition. All alarms will be unverified until the partition is armed again.

**Disabled in arm state** – option for the 91. DETECTOR MASK zone type. If the option is enabled and the zone is violated when armed, the information on detector trouble (masking) will not be stored into the event log (the event code will not be sent to the monitoring station).

#### 4.3.7 Counters

The control panel makes it possible to program 16 different counters which determine the operating mode of the counter zones (zone types 16-31). The counter parameters can be programmed:

- using the keypad, in the service mode, by means of the COUNTERS function (►ZONES ►COUNTERS).
- using the DLOADX program, in the “Zones” window, “Counters” tab.

The following should be programmed for each counter:

**Max. value** – number of violations which, if exceeded, will trigger an alarm.

**Counting time** – the time in which violations are counted.

**Counter type:**

**normal** – all violations of counter group zones are counted,

**omit recurs** – skips violations of the same zone (the alarm will be triggered, if the number of violations of different zones exceeds the maximum value).



*If the counter skips repeats, the programmed MAXIMUM COUNTER VALUE must be lower than the number of zones in counter group.*

#### 4.3.8 Bypasses

You can define a group of zones for each of the zone types from 64 to 79:

- using the keypad, in the service mode, by means of the BYPASSES function (►ZONES ►BYPASSES).
- using the DLOADX program, in the “Zones” window, “Bypasses” tab.

Having assigned the zones to a group, define what reaction should be to violation of the bypassing zone:

**Bypass only** – the zones belonging to the group will be bypassed for BYPASS TIME (see: p. 49).

**Bypass on/off** – the zones belonging to the group will remain bypassed as long as the bypassing zone is violated (they can be bypassed by the user).

**i** | *In the LCD keypad, use the **BYPASS ON/OFF** option to make your selection. Option disabled – see: **BYPASS ONLY**. Option enabled – see: **BYPASS ON/OFF**.*

#### 4.3.9 Groups of partitions

You can define up to 16 partition groups which will be controlled using the 80. **ARMING**, 81. **DISARMING**, 82. **ARM/DISARM** and 83. **CLEARING ALARM** type zones. The partition groups can be defined:

- using the keypad, in the service mode, by means of the **GROUPS** function (▶**ZONES** ▶**GROUPS**).
- using the **DLOADX** program, in the “Zones” window, “Arm/Disarm Groups” tab.

#### 4.3.10 Zone testing

Using the function available in the service mode menu in the keypad (▶**ZONES** ▶**TEST**), you can test the zones. Information on violation or tamper of the zone is displayed and signaled by beeps in keypad (violation – 5 short beeps; tamper – 1 long beep; masking – 3 long beeps). Additionally, the function allows selection of a system output which will be used for signaling during the test (zone violation will activate the output for 0.4 second, tamper – for 1,6 seconds, masking – for 3 seconds).

**i** | *Violation/tamper/masking of the zone during the test will not trigger the response programmed for the control panel zone.*

*Select a zone for testing from the list and press the **#** or ▶ key. The output allocated for signaling will stop doing its present duty (if it was active, it will be disabled) until the zone test is completed (the **\*** key pressed).*

*The output used for signaling is only remembered until exiting the **TEST** function. When the **TEST** function is re-started, the output must be selected again.*

*If wireless sirens are used in the system and any output is selected for signaling, after selecting a zone for testing from the list and pressing the **#** or ▶ key, in the wireless sirens the signaling will be unblock (which is normally blocked for the service mode duration).*

*If the output selected for signaling controls the wireless siren, it should be borne in mind that the command to block/unblock signaling is sent out during polling. This results in a delay whose duration depends on the programmed response period. Also in case of the **ASP-205** siren signaling is only triggered during the polling period.*

## 5. Outputs

---

The system supports the following outputs:

- **hardwired** – on the control panel electronics board and in expanders. The number of available hardwired outputs is determined by the control panel during identification procedure.
- **wireless** – after connecting the **ABAX 2 / ABAX** wireless system controller. The number of available wireless outputs depends on the number of wireless devices registered in the system and is determined during the procedure of adding wireless devices.
- **virtual** – the outputs which do not exist physically, but can be used e.g. for execution of logical functions.

Programming of the outputs is possible:

- using the keypad, in the service mode, by means of functions available in the OUTPUTS submenu,
- using the DLOADX program, in the “Outputs” window.

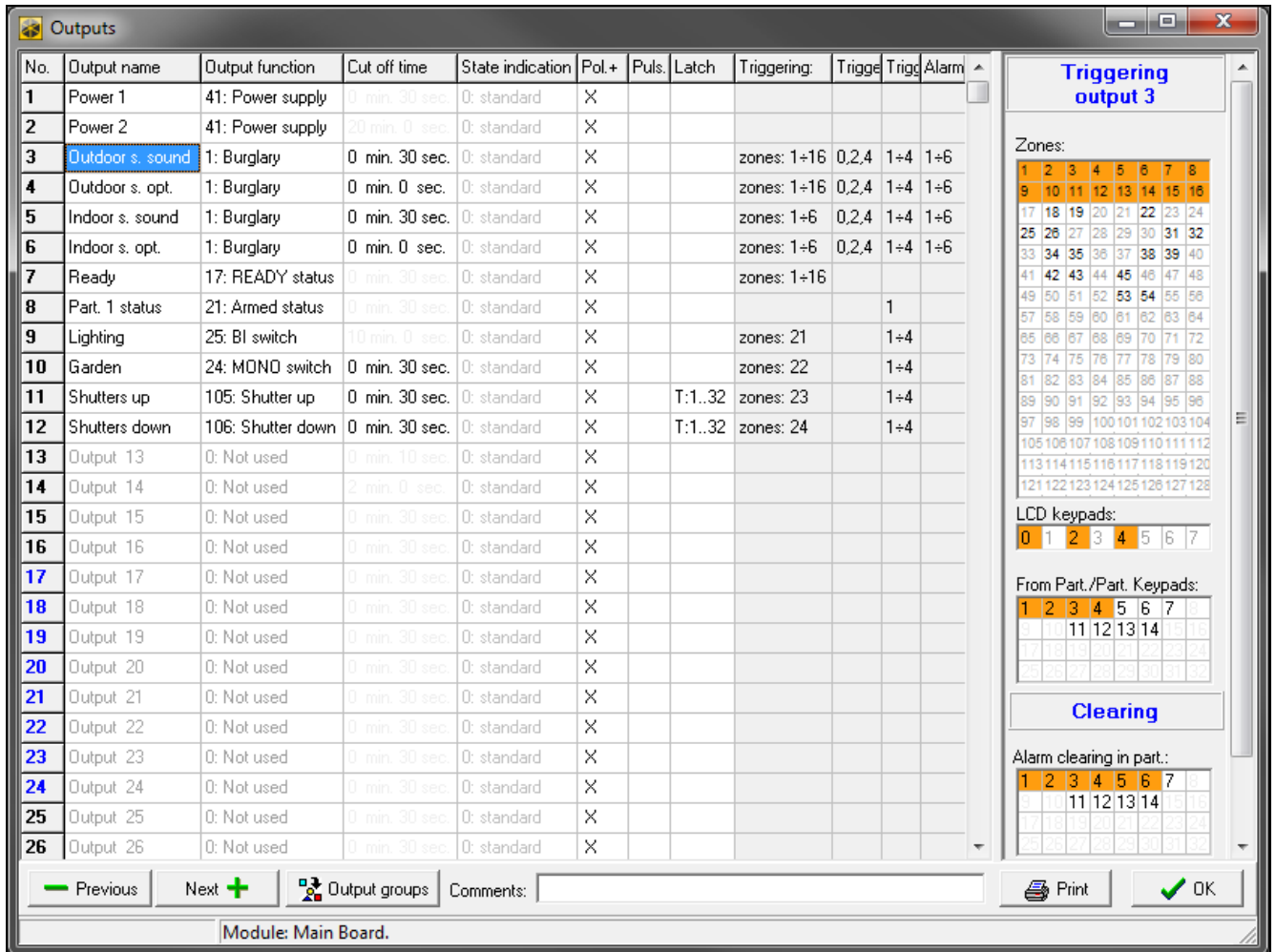

Fig. 6. “Outputs” window in the DLOADX program.

### 5.1 Output parameters

**Output name** – individual name of the output (up to 16 characters).

**Output function** (see: “Output functions”).

**Cut off time** – time during which the output is active. The cut-off time can be programmed with an accuracy of up to 0.1 second. The parameter is irrelevant for the status indicating outputs.



To set the cut-off time with an accuracy of up to 0.1 sec using the DLOADX program, right-click on the “Cut off time” column. A pop-up menu will appear, in which you must click on “Edit”.

**State indication** – instead of the output state, the state of selected zone can be displayed. This can be useful if the output is activated just for a short while to turn on / off a device and the device state is supervised by the control panel zone. In the service mode, to define how the output state is to be presented on the keypad, use the OUTS STATE BY function (►OUTPUTS GROUPS ►OUTS STATE BY).



The output status cannot be presented according to the zone 256 status.

## 5.2 Output functions

---

### 0. NOT USED

1. **BURGLARY** – signals all burglary and panic alarms (from zones, keypad/expander tamper, keypad Panic, etc.).
2. **FIRE/BURGLARY** – signals the burglary and panic alarms (continuous sound) and the fire alarms (intermittent sound).
3. **FIRE ALARM** – signals the fire alarms (from fire zones and triggered from keypads).
4. **KEYPAD ALARM** – signals the alarms triggered from keypad: fire, medical (auxiliary) and panic (except: silent panic alarm).
5. **FIRE (FROM KEYPAD)** – signals the fire alarms triggered from keypad.
6. **PANIC (FROM KEYPAD)** – signals the loud panic alarms triggered from keypad.
7. **MEDICAL ALARM (FROM KEYPAD)** – signals the medical assistance call alarm triggered from keypad.
8. **TAMPER ALARM** – signals the tamper alarms.
9. **DAY ALARM** – signals the following:
  - alarms from 13. PANIC-SILENT type zones,
  - medical alarms from the 14. MEDICAL - BUTTON and 15. PERSONAL EMERGENCY type zones,
  - alarms from 7. DAY/NIGHT type zones, if the partition to which the zone belongs is disarmed,
  - alarms from 8. EXTERIOR type zones, if the armed mode which assumes that the user will stay inside the protected facility is enabled in the partition (see: USER MANUAL),
  - alarms from 4. PERIMETER type zones, if the SIGNALING DELAY has been programmed for them,
  - alarm from 5. INSTANT and 6. EXIT type zones, if the BELL DELAY option has been enabled and the SIGNALING DELAY has been programmed for them,
  - alarms from zones, for which the REPORTING DELAY option has been enabled, provided they were violated during the ENTRY DELAY countdown,
  - unverified alarms, if the AUDIBLE ALARM AFTER VERIFICATION option is enabled for the partition,
  - the first violation of the 8. EXTERIOR type zones when they are armed, provided the SURVEILLANCE TIME has been programmed for the zone,
  - violation of the counting zones (16-31 type zones) when armed.
10. **DURESS ALARM** – action carried out under duress – signals that a DURESS type code (or prefix) has been used in the system.
11. **CHIME** – signals violation of the zones when they are disarmed.
12. **SILENT ALARM** – activates in the same situations as the 9. DAY ALARM output. Additionally, it can signal silent panic alarms.
13. **TECHNICAL ALARM** – signals alarms from zone types 40-56.
14. **ZONE VIOLATION** – indicates the violations of zones.
15. **VIDEO ON DISARMED** – controlled by zones with the VIDEO ON DISARMED option enabled.
16. **VIDEO ON ARMED** – controlled by zones with the VIDEO ON ARMED option enabled.
17. **READY STATUS** – indicates whether the system is ready for arming, i.e. whether there are no violated zones (active when there is no violation).
18. **BYPASS STATUS** – indicates the bypassing of zones.
19. **EXIT DELAY STATUS** – indicates the EXIT DELAY countdown.

- 20. ENTRY DELAY STATUS** – indicates the ENTRY DELAY countdown.
- 21. ARMED STATUS** – indicates the armed status of partitions.
- 22. FULL ARMED STATUS** – active if all selected partitions are armed.
- 23. ARM/DISARM BEEP** – signals:
- starting the arming procedure (arming, if the exit delay has not been programmed) – 1 pulse,
  - disarming – 2 pulses,
  - clearing alarm – 4 pulses,
  - denial of arming or arming procedure failure – 7 pulses.
- The pulse duration is approx. 0.3 seconds.
- 24. MONO SWITCH** – controlled by users, zones or timers. Using a code, zone violation or turning timer on will activate the output for a preprogrammed time.
- 25. BI SWITCH** – controlled by users, zones or timers. Depending on the current status, using a code or violating a zone will activate/deactivate the output. Turning the timer ON activates the output, and turning the timer OFF deactivates the output.
-  *If the 24. MONO SWITCH or 25. BI SWITCH type output is to be controlled from the keypad, it must be assigned to a group of outputs (see: “Output groups” p. 67).*
- 26. TIMER** – the output controlled by timers.
- 27. TROUBLE STATUS** – indicates the troubles.
- 28. AC LOSS (MAINBOARD)-IMMEDIATE** – indicates the loss of AC power to the control panel mainboard.
- 29. AC LOSS (TECHNICAL ZONE)** – indicates the violations of 59. TECHNICAL-AC LOSS type zones.
- 30. AC LOSS (EXPANSION MODULE)** – indicates the loss of AC power to the modules with power supply.
- 31. BATTERY TROUBLE (MAINBOARD)** – indicates a trouble with the battery connected to the control panel (low battery / no battery / high internal resistance of the battery).
- 32. BATTERY TROUBLE (TECHNICAL ZONE)** – indicates the violations of 60. TECHNICAL-BATTERY LOW type zones.
- 33. BATTERY TROUBLE (EXPANSION MODULE)** – indicates the low battery of the modules with power supply.
- 34. DETECTOR TROUBLE** – indicates the zone troubles.
- 35. TELEPHONE LINE IN USE STATUS** – indicates that the telephone communication is in use.
- 36. GROUND START** – generates a control pulse necessary for work with some types of telephone exchange.
- 37. REPORTING ACKNOWLEDGEMENT** – indicates the acknowledgement of reporting.
- 38. SERVICE MODE STATUS** – indicates that the service mode is entered.
- 39. TEST VIBRATION DETECTORS** – intended for testing the vibration detectors in one partition (see: 10. 24H VIBRATION zone type). The output cut-off time defines the duration of testing the vibration detectors in the selected partition.
- 40. CASH MACHINE BYPASS STATUS** – indicates bypassing the 11. 24H CASH MACHINE type zones in partitions with cash dispenser.
- 41. POWER SUPPLY** – intended for supplying external devices.
- 42. POWER SUPPLY ON ARMED** – dedicated to powering the detectors which should not be active when the system is disarmed. Gets active when the arming procedure is started (active during the exit delay countdown).

- 43. RESETABLE POWER SUPPLY** – the power supply output with optional reset by the user. The programmed cut-off time is the time during which the output will be turned off.
- 44. FIRE DETECTORS POWER SUPPLY** – intended for supplying the fire detectors with automatic alarm verification. Violating the fire zone will turn the power off (for the time programmed as the output cut-off time) and if another violation occurs after the power is turned on again, the fire alarm will be triggered. The output can be reset by the user.
- 45. PARTITION BLOCK STATUS** – indicates a temporary blocking of the partition armed status. If the output cut-off time is different from 0, the output will signal that the partition blocking is ending (the output will turn on for a programmed time before the blocking ends).
- 46. OUTPUTS LOGICAL AND** – active when all the control outputs with normal polarity are active and all the control outputs with reversed polarity are inactive (because of the POL.+ option, the output can be used for logical negation). See: “Logical functions of outputs” p. 68.
- 47. OUTPUTS LOGICAL OR** – active when any control output with normal polarity is active or any control output with reversed polarity is inactive (because of the POL.+ option, the output can be used for logical negation). See: “Logical functions of outputs” p. 68.
- 48...63 VOICE MESSAGE 0...15** – activated by the telephone messaging function. It enables any external device to be used for playback of notification messages. When programming the telephone messaging, the number of message to be played back is to be programmed. The messaging will turn on the corresponding output.
- 64...79 REMOTE SWITCH 1...16** – intended for control using the telephone (DTMF). The control is available to the users having a telephone code. Additionally, the outputs can be controlled using the user OUTS CONTROL function (see: USER MANUAL).
- i** *If an output of the REMOTE SWITCH type is to be controlled from the keypad, it must be assigned to a group of outputs (see: “Output groups” p. 67).*
- If a cut-off time has been programmed for a REMOTE SWITCH type output, the output will operate similarly to the 24. MONO SWITCH type output.*
- 80. NO GUARD TOUR** – indicates lack of guard tour.
- 81. AC LOSS (MAINBOARD) - LONG** – indicates the loss of AC power supply to the control panel mainboard, when the trouble lasts long enough to be saved to the event log (see: AC LOSS REPORT DELAY parameter p. 74).
- 82. AC LOSS (EXPANSION MODULE) - LONG** – indicates the loss of AC power supply to the modules with power supply unit, when the trouble lasts long enough to be saved to the event log (the delay is programmed individually in each module).
- 83. OUTPUTS OFF** – the output activates when all selected outputs stop signaling.
- 84. ACCESS CODE ENTERING** – indicates the entering the user code.
- 85. USE OF ACCESS CODE** – indicates the using a code (e.g. for system arming/disarming).
- 86. DOOR OPEN INDICATOR** – indicates the opening the door supervised by a module executing the access control functions.
- 87. DOOR TOO LONG OPENED INDICATOR** – indicates the long open door supervised by a module executing the access control functions.
- 88. BURGLARY ALARM (NO FIRE AND TAMPER)** – signals burglary alarms and PANIC alarms from keypads.
- 89. 50% OF LOG MEMORY FILLED** – informs that 50% of the event log area has been filled since the last event log reading with the DLOADX program.
- 90. 90% OF LOG MEMORY FILLED** – informs that 90% of the event log area has been filled since the last event log reading with the DLOADX program.
- 91. AUTO-ARM DELAY START** – signals starting the AUTO-ARMING DELAY countdown for a programmed time period (see: p. 46).

- 92. AUTO-ARM DELAY STATUS** – indicates the AUTO-ARMING DELAY countdown (see: p. 46).
- 93. UNAUTHORIZED ACCESS** – signals unauthorized opening of a door monitored by the module executing access control functions.
- 94. ALARM – UNAUTHORIZED ACCESS** – similarly as type 93, but the signaling only applies to modules with enabled ALARM ON UNAUTH. ACCESS option.
- 95. IP REPORTING TROUBLE** – signals troubles related to reporting via Ethernet and cellular data network.
- 96. TELEPHONE LINE TROUBLE** – informs about telephone communication troubles.
- 97. VOICE MESSAGE** – similarly as types 48-63, but the numbers of synthesizers (messages) must be selected.
- 98. REMOTE SWITCH** – similarly as types 64-79, but the numbers of remote switches must be selected.
- 99. ACCESS CARD READ** – signals read-in of the user card.
- 100. CARD HOLD – DOWN** – signals holding the user card.
- 101. CARD READ – EXPANDER** – signals that the card has been read in indicated modules/keypads.



*The 101. CARD READ – EXPANDER type output may be used for execution of the access control function from INT-KLCDR / INT-KLFR / INT-KWRL2 / INT-KWRL keypad. To do so:*

in the output settings, indicate the keypad on which reading in the card will activate the output, and the partitions from which the users will be able to open the door, in the keypad settings, assign the door opening function to presenting / holding the card and indicate the 101. CARD READ – EXPANDER type zone as the door to be opened.

- 102. LINK TROUBLE – WIRELESS ZONE** – signals lack of communication with wireless devices assigned to the selected zones.
- 103. LINK TROUBLE – WIRELESS OUTPUT** – signals lack of communication with wireless devices assigned to the selected outputs.
- 104. WIRELESS DEVICE – LOW BATTERY** – signals some problems with power supply of wireless devices.
- 105. SHUTTER UP** – dedicated for raising the roll shutters. It becomes active after violation of selected zones or disarming of selected partitions. It can also be triggered from the keypad, by means of the user function OUTS CONTROL. The cut-off time programmed for the output should be longer than that required for raising the roll shutters.
- 106. SHUTTER DOWN** – dedicated for lowering the roll shutters. It becomes active after violation of selected zones or arming of selected partitions (upon starting the arming procedure). It can also be triggered from the keypad, by means of the user function OUTS CONTROL. The cut-off time programmed for the output should be longer than that required for lowering the roll shutters.



*The roller shutter “up” and “down” functions must be assigned to consecutive (following each other) physical outputs.*

*If the 105. SHUTTER UP and 106. SHUTTER DOWN type outputs are to be controlled from the keypad, they must be assigned to a group of outputs (see: “Output groups” p. 67).*

*For the 105. SHUTTER UP and 106. SHUTTER DOWN type outputs, indicate a partition so that these outputs can be controlled from the keypad serving the given partition. If the partition status is not to control the output status, enable the NOT CONTROLLED BY ARMING option.*

- 107. CARD ON READER A** – indicates the proximity card / DALLAS iButton read-in by the expander reader A. It can also signal card reading in the LCD keypad.

- 108. **CARD ON READER B** – indicates the proximity card / DALLAS iButton read-in by the expander reader B. It can also signal card reading in the LCD keypad.
- 109. **ZONES LOGICAL AND** – active, when all zones selected as the control ones are violated.
- 110. **ALARM – NOT VERIFIED** – signals unverified alarms.
- 111. **ALARM – VERIFIED** – signals verified alarms.
- 112. **VERIFIED – NO ALARM** – informs that the alarm has not been verified (during the alarm verification no alarm was triggered by any other zone included in the verification).
- 113. **VERIFICATION DISABLED STATUS** – signals disabling alarm verification.
- 114. **ZONE TEST STATUS** – indicates the zone testing by means of user functions.
- 115. **ARMING TYPE STATUS** – active when selected partitions are armed in the selected mode.
- 116. **INTERNAL SIREN** – signals the same alarms and violations as the 1. BURGLARY or 9. DAY ALARM output type (logic product of the 1. BURGLARY and 9. DAY ALARM outputs).
- 117. **TAMPERING STATUS** – informs about tamper of selected zones, keypads and expanders.
- 118. **KEYFOB BATTERY LOW** – informs about low battery in keyfobs belonging to selected users. Refers to the 433 MHz keyfobs (supported by the INT-RX or INT-RX-S modules) or the APT-200 (supported by the ABAX 2 / ABAX system) / APT-100 keyfobs (supported by the ABAX system).
- 119. **WIRELESS SYSTEM JAMMING** – indicates the jamming of device supporting the ABAX 2 (ACU-220 or ACU-280 controller) / ABAX wireless system (ACU-120, ACU-270, ACU-100 or ACU-250 controller).
- 120. **THERMOSTAT** – the output activates when temperature drops below a preset value. The control panel can receive the temperature data from wireless temperature detectors or ABAX 2 wireless devices provided with a temperature sensor. For more information, refer to section “120. Thermostat output settings” p. 66.
- 121. **MASKING** – signals for a programmed time masking the detectors connected to the 3EOL zones.
- 122. **MASKING STATUS** – indicates the masking the detectors connected to the 3EOL zones.

### 5.3 Options

**Pol.+** – defines the output operating mode (see Table 5).

	<b>high-current output</b>	
	option enabled (normal polarity)	option disabled (reversed polarity)
active status	+12V voltage supply	+12V voltage cut-off
inactive status	+12V voltage cut-off	+12V voltage supply
	<b>low-current output</b>	
	option enabled (normal polarity)	option disabled (reversed polarity)
active status	shorted to ground	isolated from ground
inactive status	isolated from ground	shorted to ground

Table 5. Functioning of outputs, depending on the POL.+ option.

**Pulsating** – the option refers to timed outputs. If it is enabled, the output operates in a pulsating mode. If it is disabled, the output operates continuously.

**Latch** – the option refers to alarm outputs. If it is enabled, the output will be active until the alarm is cleared by the user.

**Active during violation** – the option applies to the 24. MONO SWITCH output. If enabled, the output is always active when a control zone is violated, and the countdown of output cut-off time will only be running after the violation ends.

**Timer activates/deactivates** – the option applies to the 24. MONO SWITCH and 25. BI SWITCH outputs. If enabled, the output can be controlled by selected timers. Turning the timer ON activates the output (in case of the 24. MONO SWITCH type output – for a programmed time), and turning the timer OFF deactivates the output.

**ON/OFF** – the option refers to the 24. MONO SWITCH type outputs. If it is enabled, violation of the control zone when the output is on will turn the output off. If the option is disabled, each violation of the control zone will turn the output on for a preset time.

**AC loss fast** – the option refers to the 28. AC LOSS (MAINBOARD)-IMMEDIATE type outputs. If this option is enabled, the output will be activated immediately after the AC power is lost. If this option is disabled, the output will be activated 10 seconds after the AC power is lost.

**Not controlled by arming** – the option refers to the 105. SHUTTER UP and 106. SHUTTER DOWN type outputs. If enabled, the partition arming / disarming has no effect on the output status.

## 5.4 Output triggering

---

**Zones** – indicate the zones. The output will be controlled by events related to these zones.

**LCD keypads** – indicate the LCD keypads. The output will be controlled by events related to these LCD keypads.

**Partitions** – indicate the partitions/partition keypads. The output will be controlled by events related to these partitions/partition keypads.

**Timers** – indicate the timers which will control the output.

**Master users / users** – indicate the masters/users. The output will be controlled by events related to these masters/users.

**Outputs** – indicate the output. The output will be controlled by events related to these outputs.

**Expanders** – indicate the expanders. The output will be controlled by events related to these expanders.

**Troubles** – indicate the troubles. The output will be activated by occurrence of these troubles.

**Voice mess.** – indicate the synthesizers. The output will be active when the voice messages with indicated numbers are played back.

**Remote switches** – indicate the remote switches. The users will control the output by controlling the selected switches via the telephone.

**Burglary zones in partition** – indicate the partition in which the output will be activated by starting the test of burglary zones.

**Fire/technical zones in partition** – indicate the partition in which the output will be activated by starting the test of fire or technical zones.

**Arm mode** – indicate the arm mode whose activation will activate the output.

**Telephone usage type** – indicate which cases of using the telephone communication by the alarm control panel will activate the output.

## 5.5 Clearing alarm in partitions

---

Indicate the partitions in which alarm clearing will be available (the users having access to these partitions will be able to clear the alarm).



*The alarm must be signaled in the partition where it is to be cleared. If no alarm is being signaled by the given partition, it will be impossible to clear it.*

## 5.6 Output disabling

---

**Disabling timers** – for the 105. SHUTTER UP and 106. SHUTTER DOWN type outputs, you can indicate the timers which will block the output. When the timer is active, disarming (105. SHUTTER UP) / arming (106. SHUTTER DOWN) will not activate the output.

**Partitions** – for the 11. CHIME type output, you can indicate the partitions from which the user will be able to block the output using the OUTPUTS CHIME function.

## 5.7 120. Thermostat output settings

---



*The 120 THERMOSTAT type output settings are used to adjust the operating parameters of the ART-200 wireless radiator thermostats.*

**Temperature detector** – zones used to provide data on temperature. Data on temperature can be received from ABAX 2 wireless devices provided with temperature sensors. The devices must be assigned to these zones.

**Temperature T1** – the first temperature threshold (economic temperature). It is active when all control timers are OFF or the forcing output is active. If the first temperature threshold is active, the output will be turned on when the temperature drops below temperature T1 (economic temperature).

**Temperature T2** – the second temperature threshold (comfortable temperature). It is active when the control timer is ON or the forcing output is inactive. If the second temperature threshold is active, the output will be turned on when the temperature drops below temperature T2 (comfortable temperature).

**Hysteresis** – temperature difference between turning the output on and off. The output will be turned on when temperature drops below the threshold by a value higher than the hysteresis. The output will be turned off when temperature reaches the threshold. Hysteresis is used to eliminate the undesirable output state changes when temperature fluctuations occur.



*The user can edit the temperature thresholds and hysteresis using the TEMPERATURES user function available in the CHANGE OPTIONS submenu.*

**Output forcing T1** – output that forces temperature T1 to be active. If the output is turned on, the first temperature threshold (economic temperature) will be active. If the output is turned off, the temperature thresholds will be controlled by timers. If the forcing output is not selected, the temperature thresholds will only be controlled by timers.



*The output 256 cannot be indicated as the forcing one.*

**Timers controlling T1/T2** – timers used to control the temperature thresholds. If the timer is turned on, the second temperature threshold will be active (unless the forcing output is turned on).

**Timers set** – if this option is enabled, the output can be controlled by timers 33-64. If this option is disabled – by timers 1-32.



*The user can edit the parameters of control timers using the TIMERS user function available in the CHANGE OPTIONS submenu.*

**Edition in ART-200** – if this option is enabled, the keys on the ART-200 wireless radiator thermostat will be enabled. This means they can be used to:

- change the operating mode (when the operating mode is changed manually, the thermostat will not use the active temperature threshold of the thermostatic output),

- change the temperature threshold settings (when the settings are changed in the thermostat, the thermostatic output settings will also be changed),
- start other functions available in the thermostat.

If this option is disabled, the keys on the ART-200 thermostat will be disabled.

### 5.7.1 Rules for programming the thermostatic output settings

#### **Temperature programming rules**

You can enter a value from -30°C to 70°C (with accuracy to 0.5°).



*The ART-200 wireless radiator thermostat regulates temperature in the range from 5°C to 30°C.*

#### **Hysteresis programming rules**

You can enter a value from 0°C to 7.5°C (with accuracy to 0.5°). If you program 0°C, the thermostat will be turned on when the temperature drops below the threshold by 0.5°C.

## 5.8 Output groups

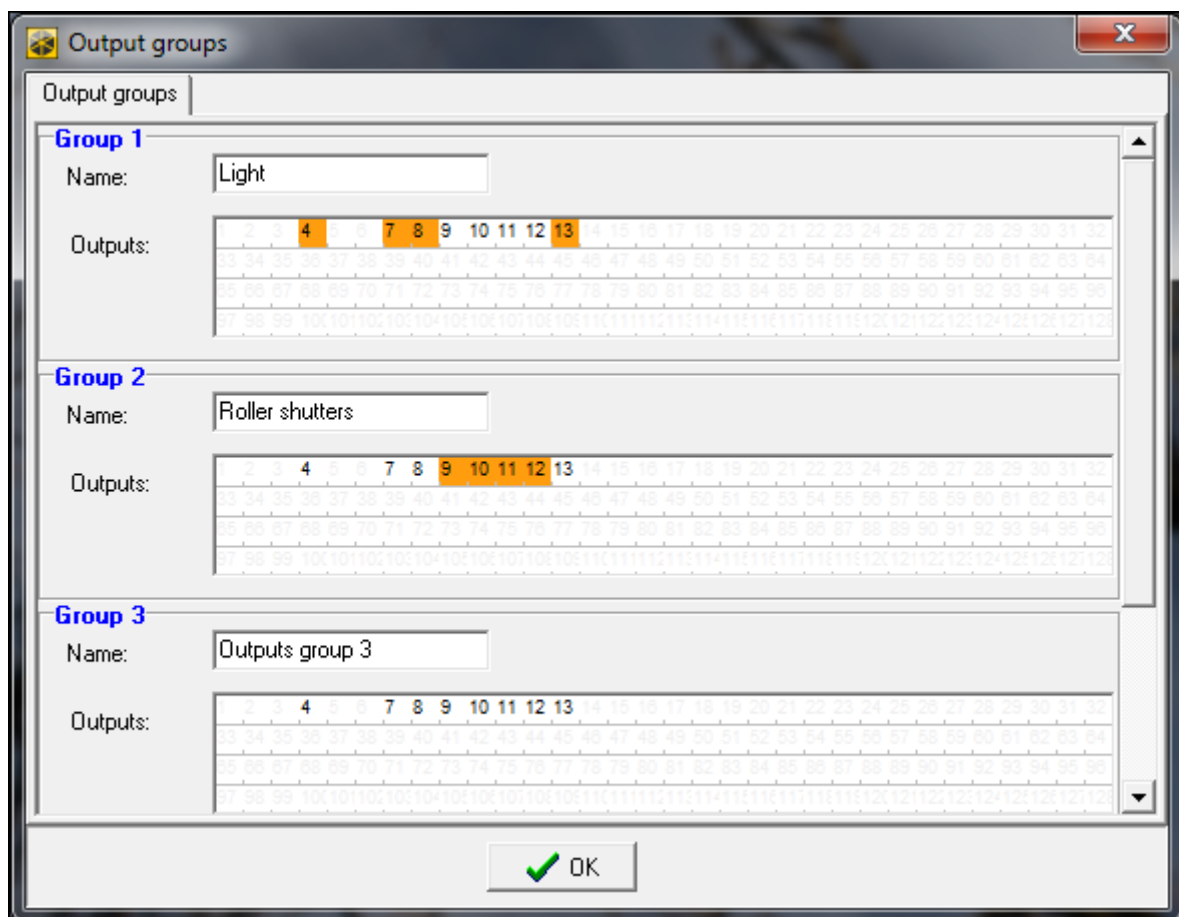

Fig. 7. Window “Output groups” in the DLOADX program.

The outputs of MONO SWITCH, BI SWITCH, REMOTE SWITCH, SHUTTER UP and SHUTTER DOWN type can be grouped by the function performed by them. Each group may be given a name.

The output groups can be defined:

- using the keypad, in the service mode, by means of the OUTPUT GROUPS function,
- using the DLOADX program, in the “Output groups” window (to open the window, press the “Output groups” button in the “Outputs” window).



*If all outputs are assigned to one group of outputs, the keypad will not display the list of output groups upon starting the REMOTE CONTROL user function, but it will immediately display the list of outputs which can be controlled.*

*The output can be assigned to a few groups.*

*If the output is not assigned to any group, it cannot be controlled from the keypad.*

## 5.9 Logical functions of outputs

---

It is possible to use any number of outputs as virtual outputs to control the 46. OUTPUTS LOGICAL AND or 47. OUTPUTS LOGICAL OR type output.

### Example of using output functions 46 and 47

1. Assign functions to the outputs which do not physically exist:
  - output 63: function 1. BURGLARY,
  - output 64: function 23. ARM/DISARM BEEP.
2. Program the output 1, to which the siren is connected, as 47. OUTPUTS LOGICAL OR, and select the outputs 63 and 64 as the controlling ones. The output 1 will be turned on, if the output 63 or 64 is active.
3. Program the output 62, which does not exist physically, as 26. TIMER type. Program the timer, which is to control the output, as a daily one, turned on at 16.00 and turned off at 8.00.
4. Program the output 2, to which the siren is connected, as 46. OUTPUTS LOGICAL AND, and indicate the outputs 1 and 62 as the controlling outputs. As a result, the output 2 will signal alarms and confirmation of partition arming/disarming, but only from 16:00 to 8:00. Beyond these hours, the output will be inactive.

## 5.10 Output testing

---

Using the function available in the service mode menu in the keypad (►OUTPUTS ►TEST), you can test the outputs. After starting the function, the list of system outputs will be displayed. Select the output to be tested and press the # or ► key. The keypad will display a submenu which enables the output testing. By using the # or ► key, you can activate/deactivate the output. You can also deactivate the output by means of the numerical keys. Press \* to quit the submenu and return to the list of system outputs.



*The output under test will stop performing its previous function (if it was active, it will be deactivated).*

*If there are wireless sirens in the system, starting the function of output testing will unblock the signaling in them (the signaling is normally blocked for the service mode duration). It should be remembered that the command to block/unblock the signaling is sent out during polling. This will cause a delay whose duration depends on the programmed response period.*

*When testing the control output for ASP-205 wireless siren, it should be remembered that the signaling is only triggered during the polling.*

## 6. System options

---

Most of the options and parameters described in this section can be programmed:

- using the keypad, in the service mode, by means of the functions available in the OPTIONS submenu,
- using the DLOADX program, in the “Options” window.

Shown in square brackets are the names used in keypads.

## 6.1 Telephone options

**Reporting - TELEPHONE** [Mon.TELEPHONE] – with this option enabled, the control panel can send event codes by means of the telephone line.

**Reporting - GPRS** [Mon.GPRS] – if this option is enabled, the control panel can send event codes via the cellular data network (LTE/GPRS) by using the SATEL GSM module.



*The REPORTING – GPRS option does not apply to reporting via the cellular data network by using the INT-GSM / INT-GSM LTE module.*

**Reporting - ETHM** [Mon.ETHM-1] – the option is available if the ETHM-1 Plus / ETHM-1 module is connected to the control panel, but the INT-GSM / INT-GSM LTE module is not included in the alarm system. If this option is enabled, the control panel can send event codes over Ethernet by using the ETHM-1 Plus / ETHM-1 module.

**Reporting – ETHM/INT-GSM** [Mon.ETHM-1] – the option is available if the INT-GSM / INT-GSM LTE module is installed in the alarm system. If this option is enabled, the control panel can send event codes via Ethernet by using the ETHM-1 Plus / ETHM-1 module and/or via the cellular network (cellular data / SMS) by using the INT-GSM / INT-GSM LTE module.

**Telephone messaging** [Messaging] – if this option is enabled, the control panel can send notifications via the telephone network of the occurrence of specific events using voice or text messages defined by the installer.

**SMS messaging** – if this option is enabled, the control panel can send event notifications by using SMS messages whose content is created automatically, based on the control panel event log. The SATEL GSM module must be connected to the control panel.



*If the INT-GSM / INT-GSM LTE module is installed in the alarm system, the SMS MESSAGING option is not available. The SMS MESSAGING option does not apply to SMS messaging by the INT-GSM / INT-GSM LTE module.*

**E-mail messaging** [E-MAIL messag.] – if this option is enabled, the control panel can send event notifications by e-mail messages, the content of which is created automatically, based on descriptions from the control panel event log. ETHM-1 Plus or INT-GSM / INT-GSM LTE module must be connected to the control panel.

**Answering - modem** [Modem answer.] – with this option enabled, external initiation of the communication between modem and control panel is possible.

**Answering - audio** [Voice answer.] – with this option enabled, the control panel will carry out the function of call answering.



*The ANSWERING - AUDIO option must be enabled, if the users are to operate the alarm system using the interactive voice menu offered by the INT-VG module.*

**Remote control** – with this option enabled, the control panel allows the users having a telephone code to operate the REMOTE SWITCH outputs by using a phone. The option is available if the ANSWERING – AUDIO is enabled.

**External modem** [External modem] – with this option enabled, the control panel will support an external modem connected to the control panel RS-232 port.

**Modem ISDN/GSM/ETHM** [ISDN/GSM modem] – enable this option if the ETHM-1 Plus / ETHM-1 / INT-GSM / INT-GSM LTE / GSM / ISDN module is connected to the control panel RS-232 port. The option is available if the EXTERNAL MODEM option has been enabled.

**Answering - ETHM/GSM** [Ext.mod.answ.] – if this option is enabled, it is possible to establish connection with the alarm control panel via the ETHM-1 / ETHM-1 Plus module, INT-GSM / INT-GSM LTE module, GSM or ISDN modem. The option is available, if the

EXTERNAL MODEM and MODEM ISDN/GSM/ETHM options are enabled. The option is not available when the ANSWERING - MODEM option is enabled, which also enables to establish connection with the alarm control panel via the ETHM-1 / ETHM-1 Plus module, INT-GSM / INT-GSM LTE module, GSM or ISDN modem.

**Tone dialing** – with this option enabled, the control panel will tone dial the telephone numbers (pulse dial, if this option is disabled).

**Ground Start** – with this option enabled, the control panel will use the Ground Start method to obtain signal on the telephone line (by grounding temporarily the telephone line wires). Enable this option, if required by your phone service provider.

**No dial tone test** [No dialton.tst] – with this option enabled, the control panel will not perform the test for dial tone before dialing the number and will start dialing the number 5 seconds after going “off hook”. This makes it possible for the control panel to dial the number when some non-standard tones occur after going off hook (e.g. interrupted tone). When this option is disabled, the control panel will start dialing the number 3 seconds after going off hook, provided that the dial tone is present.

**No answer test** – with this option enabled, in case of notifying by means of voice messages, the control panel will not perform the test for “off hook” condition. The voice message will be played back 15 seconds after completion of the number dialing.

**Double voice message** [Dbl. voice msg.] – with this option enabled, the voice message is played back twice during telephone messaging.

**Double call** – with this option enabled, the control panel must be called twice for the modem communication to be established. The first time you must wait for the preprogrammed number of rings and hang up. Then you must call back within three minutes and the control panel will answer the call immediately. This solution makes it possible to connect after the control panel some additional devices which will be activated after a preset number of rings (e.g. answering machine, fax, etc.).

**Pulse dialing 1/1.5 (off 1/2)** – this option applies to dialing the telephone numbers by using the pulse mode. Before you enable it, make yourself familiar with the valid standard of pulse dialing.

**Rings before answer** [Rings to answer] – number of rings after which the control panel will go off hook.

## 6.2 Printer options

---

**Printing** – the option enables on-line events printout by the printer connected to the RS-232 port of control panel mainboard.

### 6.2.1 Printout options

**Include reporting status** [Monitor.status] – on the printout will appear the information if the particular event was sent to the monitoring station (printout of the event information will take place not immediately but after transmission to the station has been completed).

**Print names/descriptions** [Names/descript] – determines if, besides the numbers of zones, outputs, modules and users, also their names and descriptions are to be printed.

**Wide paper** – printout width will be 132 columns (if the option is disabled: 80 columns).

**2400 bps (off:1200 bps)** – data will be sent to RS-232 port at a rate of 2400 bps (if the option is disabled - at a rate of 1200 bps).

**CR+LF (off: CR)** – parameter determining the control mode of paper feed in the printer.

**Use parity bit** – the parity check of data transferred from the control panel to the printer is enabled.

**Parity EVEN (off: ODD)** – option determines the mode of parity check of data transferred from the control panel to the printer. The option is relevant only if the USE PARITY BIT option is active.



*The other parameters of RS-232 transmission are permanently programmed (8 data bits, 1 stop bit).*

*All the parameters regarding transmission through RS-232 (i.e. transmission rate, CR+LF, parity, data bits and stop bits) are to be set identically on the control panel and on the connected printer. Otherwise the printer will not operate at all, or the printout will be illegible.*

### 6.2.2 Printout contents

The options define what kind of information will be contained in the printout.

## 6.3 Other options

---

**Permitted “simple” access codes** [Simple codes] – with this option enabled, with this option enabled, it is possible to use codes containing less than three different digits (e.g. 1111 or 1212) or consisting of consecutive digits (e.g. 3456).

**Notify of necessity to change access code** [Notify of code] – with this option enabled, the keypad will notify the user of the necessity to change access code, if it is known to other users.

**Confirm commands with “1”** [Confirm with 1] – if this option is enabled, the LCD keypad will require, in case of some functions, additional confirmation with the key 1.

**Clear messaging on alarm clearing** [Autoabort msg.] – with this option enabled, clearing the alarm can automatically cancel messaging about this alarm, if the user clearing the alarm has the TELEPHONE MESSAGING CANCELING right.

**Return to menu from Service Mode** [SM -> menu] – if this option is enabled, exiting the service mode will be followed by return to the user menu instead of to the basic operating mode of the keypad.

**Return to menu from menu “Test”** [Tests -> menu] – if this option is enabled, exiting the user function available in the TESTS or CHANGE OPTIONS submenu will be followed by return to the submenu instead of to the basic operating mode of the keypad.

**Fast module bus communication** [Fast exp. bus] – it is recommended to enable this option to speed up communication with the modules. The option should only be disabled in case of extended security alarm systems, where electric interference may cause problems with communication.

**No module restart reports** [No rest. mon.] – when the option is enabled and the Contact ID or SIA format is used for reporting, no event codes referring to module restarts will be sent to the monitoring station.

**Service message after tamper alarm** [Inf.aft.tamper] – when the option is enabled, after any tamper alarm, the keypads can display on LCD display the message informing that service maintenance is necessary. The message will be cleared after entering the service code and confirming it with the # key.

**Backlight off on AC loss** [No AC-no blght] – when this option is enabled, the backlighting in keypads can be automatically switched off in case of 230 V AC power loss.

**Block keypad after 3 wrong codes** [Blk aft.w.code] – with this option enabled, entering an invalid code (reading in an invalid card / DALLAS iButton) three times will block the keypad (reader) for 90 seconds. After expiry of that time, each next entry of an invalid code (read-in of an invalid card / DALLAS iButton) will block the device immediately.



**Trouble memory until review** [Troubl. memory] – if the option is enabled, the trouble memory can be signaled until it will be cleared (clearing the trouble memory is possible when exiting the function of viewing troubles in the keypad or in the “Troubles” window, DLOADX program).

**Do not show alarm if armed** [Hide alarms] – with this option enabled, no alarms will be indicated in keypads during the armed mode.

**Limit events** [Events limit.] – with this option enabled, while armed events from the same source will be saved into the event log and reported to the monitoring station 3 times only.

**Alarming zones review** [View clear.al.] – if this option is enabled, in the LCD keypad the zones that triggered the alarm can be reviewed immediately after the alarm is cleared.

**Grade 3** – with this option enabled, the system operates as required by the EN 50131 standard for Grade 3, i.e.:

- starting the arming procedure may be impossible, or, if started, the arming procedure may fail, if some zones are violated in the partition, or there is a trouble in the system,
- LCD keypads, partition keypads, proximity card arm/disarm devices and reader expanders do not signal alarms,
- the  LEDs in keypads indicate alarms only when code has been entered and confirmed with the \* key,
- the flashing  LED in keypads means that there is a trouble in the system, some zones are bypassed, or there has been an alarm,
- new access codes in the system must be composed of at least 6 characters (USER CODE MIN. LENGTH parameter),
- information on the arm status is displayed for maximum 60 seconds (NO ARMED INDICATION AFTER parameter),
- the following global options are enabled (cannot be disabled):
  - TROUBLE MEMORY UNTIL REVIEW,
  - DO NOT SHOW ALARM IF ARMED,
  - BLOCK KEYPAD AFTER 3 WRONG CODES,
  - WARN WHILE ARMING IF TROUBLE,
  - DISPLAY VIOLATED/BYPASSED ZONES ON ARMING,
  - DO NOT REPORT SATEL SERVER CONNECTION TROUBLE,
  - DO NOT REPORT SMTP SERVER CONNECTION TROUBLE,
  - DO NOT REPORT TIME SERVER CONNECTION TROUBLE,
- the following global options are disabled (cannot be enabled):
  - DO NOT ARM IF TAMPERED,
  - DO NOT ARM IF BATTERY TROUBLE,
  - REQUIRED SYSTEM RESET AFTER VERIFIED ALARM,
  - DO NOT ARM IF TROUBLE,
  - DO NOT ARM IF OUTPUTS TROUBLE,
  - DO NOT ARM IF REPORTING TROUBLE,
- the TAMPER ALARM ALWAYS LOUD option is disabled for all zones, keypad and expander buses (the option cannot be enabled),
- the VALID WITHIN 30 SEC option is enabled for all partitions (cannot be disabled),
- the entry delay time (global and for individual zones) can be up to 45 seconds (if longer, it will be automatically reduced) for the 0. ENTRY/EXIT, 1. ENTRY, 2. DELAYED, 3. INTERIOR DELAYED, 85. ENTRY/EXIT – CONDITIONAL, 86. ENTRY/EXIT – FINAL, 94. ENTRY/EXIT INTERIOR and 95. ENTRY INTERIOR zone types,

- the REPORTING DELAY option is enabled for the 4. PERIMETER, 5. INSTANT, 6. EXIT, 7. DAY/NIGHT and 64...79 BYPASSING – GROUP: 1...16 zone types (the option cannot be disabled),
- the ABORT DELAY option is enabled for the 0. ENTRY/EXIT, 1. ENTRY, 2. DELAYED, 3. INTERIOR DELAYED, 85. ENTRY/EXIT – CONDITIONAL, 86. ENTRY/EXIT – FINAL, 94. ENTRY/EXIT INTERIOR and 95. ENTRY INTERIOR zone types (the option cannot be disabled),
- the PRIORITY option is enabled for the 9. 24H TAMPER zone type (the option cannot be disabled),
- the AUTO-RESET 3 and AUTO-RESET 1 options are disabled for the 12. PANIC AUDIBLE and 13. PANIC SILENT zone types (the options cannot be enabled),
- AC loss report delay (for the control panel and all modules with power supply units) can be up to 60 minutes (if longer, it will be automatically reduced),
- AC loss report delay (for the control panel and all modules with power supply units) cannot be equal to 0 (if the value 0 is entered, 1 minute will be programmed),
- the quick arming is not possible (relevant parameters in keypads settings are automatically modified),
- the SHOW ARM MESSAGES option is enabled in all keypads (it cannot be disabled),
- the following options are disabled in all keypads (they cannot be enabled):
  - SIGNALING TROUBLES IN PARTIALLY ARM,
  - SIGNAL NEW TROUBLE,
  - ALARM MESSAGES: PARTITIONS,
  - ALARM MESSAGES: ZONES,
  - SHOW VIOLATED ZONES,
  - DISPLAY MODE SWITCHING,
- it is not possible to view the status of zones, partitions, alarms, trouble memory and current troubles by pressing and holding down the dedicated keypad keys (the corresponding options are disabled and cannot be enabled),
- it is not possible to present information on partition status in the bottom line of keypad display (relevant parameters in the keypad settings will be automatically modified),
- after entering the user menu by means of the service code, you will get access in the EVENTS submenu to the GRADE 3 function, which enables viewing the events required by EN 50131 for Grade 3,
- the ISOLATE user function is only available to the installer,
- the SYSTEM STATE user function provides information about alarms, bypassed zones, troubles and partition status (disarmed or type of armed mode).

**Tamper if no communication with ABAX device (2h)** [L.no ABAX=tamp] – with this option enabled, tamper alarm will be triggered if there is no communication with a wireless device of the ABAX 2 / ABAX system for 2 hours.

**No shortcuts in menu** – if this option is enabled, the user menu shortcuts are not supported.

**Do not report SATEL server connection trouble** [No SATEL trbl.] – if this option is enabled, loss of communication with the SATEL server will not be reported as trouble.

**Do not report LAN loss on AC loss** [No LAN(AC) tr.] – if this option is enabled, trouble will not be reported after Ethernet network loss in the event of control panel AC power failure.

## 6.4 Arming options

---

**Display violated/bypassed zones on arming** [Arm, view viol] – if this option is enabled, the user will be informed of the violated / bypassed zones when arming the system from keypad.



*If the system is being armed in the “full + bypasses” mode, bypasses and violations of the zones for which the BYPASSED IF NO EXIT option is enabled are not checked.*

*If the system is being armed in the “without interior” or “without interior and without entry delay” mode, bypasses and violations of the 3. INTERIOR DELAYED type zones are not checked (unless the DELAY IN 2&3 TYPE ARMING option is enabled for the zone).*

**Warn while arming if trouble** [Arm, warn.trb.] – if this option is enabled, the user will be informed of the existing troubles, if any, when arming the system from keypad.

**Do not arm if tampered** [If tamper] – if this option is enabled, arming will be impossible if a tamper is discovered.

**Do not arm if reporting trouble** [If monit.trbl.] – if this option is enabled, arming will be impossible in case of any problems with reporting.

**Do not arm if battery trouble** [If batt. trbl.] – if this option is enabled, arming will be impossible in case of a battery failure.

**Do not arm if outputs trouble** [If outs. trbl.] – if this option is enabled, arming will be impossible when the control panel detects that the mainboard outputs are overloaded or devices connected to these outputs are cut off.

**Do not arm if trouble** [If other trbl.] – if this option is enabled, arming will be impossible in case of a trouble.

**Required system reset after verified alarm** [If verif. al.] – if this option is enabled, arming will be impossible after a verified alarm.



*The options DO NOT ARM IF TAMPERED, DO NOT ARM IF BATTERY TROUBLE, DO NOT ARM IF TROUBLE, DO NOT ARM IF OUTPUTS TROUBLE and DO NOT ARM IF REPORTING TROUBLE are available, when the WARN WHILE ARMING IF TROUBLE option is enabled.*

## 6.5 Times

---

**Global entry delay** – parameter taken into account in the delayed zones, for which the programmed ENTRY DELAY is equal to 0.

**Global alarm time** – time of signaling alarm in keypads, proximity card arm/disarm devices, proximity card readers and DALLAS chip readers.

**No armed indication after** – time counted from the moment of partition arming, during which information about armed status is displayed on the keypads. Programming the value 0 means that keypads will indicate the armed status as long as the partition is armed.

**AC loss report delay** – time during which the control panel must not receive AC power so that information of it can be saved to the event log. Having programmed the value 0 means that the information of AC power loss will not be saved to the event log.

**Tel. line loss report delay** – time during which abnormal voltage must be on the telephone line for the control panel to report the telephone line trouble. This delay prevents the reporting of short-time voltage dips (e.g. during a phone call) or decays. If you enter 0, the control panel will not report the telephone line trouble.

**Default part. block time** – the time period during which the WITH TEMPORARY BLOCK type partitions with enabled DEFAULT BLOCK TIME option will be blocked.

**Summer/winter time** [Daylight saving] – the control panel can automatically adjust the clock settings due to a change from the summer time to the winter time according to the selected schedule.

**Summer time from** – if the control panel clock is to be corrected by 1 or 2 hours according to dates, you should enter the dates (day, month) after the clock is changed to the summer time (moved forward).

**Winter time from** – if the control panel clock is to be corrected by 1 or 2 hours according to dates, you should enter the dates (day, month) after the clock is changed to the winter time (moved back).

**RTC clock correction** [Clock adjustm.] – if the accuracy of control panel clock is inadequate, the clock settings may be adjusted once per 24 hours (at midnight) by a defined time. The correction time is programmed in seconds. The maximum correction can be  $\pm 19$  seconds per 24 hours.

**Time server** – if the control panel is to synchronize the time with the server (automatically and after suitable function is enabled by the installer or master user), enter the address of time server supporting the NTP protocol. Time synchronization is possible when the ETHM-1 / ETHM-1 Plus / INT-GSM / INT-GSM LTE module is connected.

**Time zone** – if the control panel is to synchronize the time with the server, indicate the time zone, i.e. the difference between the universal time (GMT) and the zone time.

**Do not report time server connection trouble** [No t.serv.trbl] – with this option enabled, no trouble will be reported if there is no communication with the time server.

## 6.6 Service options and parameters

---

In the keypad, most of the options and parameters, as described below, are available in SM SETTINGS submenu.

**Service access code** – a code that allows access to the service mode, as well as some functions in the user menu.

**Disable service mode** [Block SM] – with this option enabled, entering the service mode “from pins” (by hardware means) will be impossible (entering the service mode “from pins” will only be possible if the control panel factory settings are restored).

**Disable downloading** [Block DWNL] – with this option enabled, starting communication with the DLOADX program “from pins” will be impossible.

**Hide service mode after** [Hide SM after] – the time counted from the last operation performed in the service menu, after expiry of which the service mode menu will be hidden (see: p. 6). If value 0 is programmed, the automatic hiding of the service mode will be disabled.

**Service mode beep** [SM sounds] – with this option enabled, the service mode will be acoustically signaled in the keypad.

**User code min. length** [Min. code length] – the minimum required number of digits in the user code. The parameter will be taken into account when creating and editing the codes (but it has no effect on the codes already existing in the system).

## 6.7 Other parameters

---

**Prefix length** – the required number of digits in the prefix. Entering a number different from 0 means that from now each code will have to be preceded by a prefix:

- **normal** – for everyday use. By default, it consists of a suitable number of digits 0 (e.g. if the prefix length has been set at 4, the default prefix will be: 0000),
- **DURESS** – to be used, when the user is forced to enter the code. If used, a silent alarm will be triggered. By default, it consists of a suitable number of digits 4 (e.g. if the prefix length has been set at 3, the default prefix will be: 444).

The prefixes and their validity can be programmed by the administrator (master), using the CHANGE PREFIX function.



*Each change of the prefix length restores the prefix factory values.*

*The service code need not be preceded by a suitable prefix – it is enough when the number of digits preceding the code matches the prefix length.*

**PING test** – the ETHM-1 (firmware version 1.05 or newer) / ETHM-1 Plus modules can test communications by using the PING command sent to the indicated network device. The ETHM-1 / ETHM-1 Plus module will be testing communication after the parameters described below are configured and the PING TEST option is enabled in the module itself. In the DLOADX program, you can program the PING test parameters in the “Structure” window, “Hardware” tab, after you click on the keypad bus.

**Address to test [PING]** – address of the device to which the module is to send the PING command to test communications. It can be entered as an IP address (4 decimal numbers separated by dots) or as a name.

**Period [PING period]** – the interval between consecutive communication tests by using the PING command. If value 0 is programmed, the communication test will be disabled.

**Tries no. before trouble [PING tries]** – the number of unsuccessful communication tests (the module has received no answer to the PING command sent) after which trouble will be reported. If value 0 is programmed, the communication test will be disabled.

**Integration encryption key [Integrate key]** – if the ETHM-1 / ETHM-1 Plus module is used for integration of the control panel with other systems and the communication over Ethernet network is to be encrypted, enter the key with which the data will be encrypted: up to 12 alphanumeric characters. In the DLOADX program, the encryption key can be programmed in the “Structure” window, “Hardware” tab, after clicking on the keypad bus.

## 6.8 Default user's authority level

---

You can define which user rights will be automatically assigned to a new user. The list of permissions can be modified during user creating or editing.

## 7. Programming the keypads

---

You can program the keypads:

- using the keypad, in the service mode, by means of the functions available in the LCD KEYPADS submenu (►STRUCTURE ►HARDWARE ►LCD KEYPADS) – having selected the SETTINGS or NAMES function, choose the keypad,
- using the DLOADX program, in the “Structure” window, “Hardware” tab, after clicking on the keypad name.

### 7.1 Keypad parameters and options

---



*This section covers the INT-KLCD, INT-KLCDR, INT-KLCDK, INT-KLCDL, INT-KLCDS and INT-KLFR keypads. Parameters and options for other keypads are described in their respective dedicated manuals.*

Shown in the square brackets are the names, as used in the keypads.

#### 7.1.1 Keypad

**Name** – individual name of the LCD keypad (up to 16 characters).

**Partitions managed by keypad [Partitions]** – partitions which can be armed/disarmed or alarm in which may be cancelled from the keypad. These functions are available to the users having appropriate rights and access to these partitions.



*Using the service code you can operate all partitions, irrespective of which partitions are operated by the keypad.*

**Show alarms of partitions** [Alarms] – the keypad can signal burglary alarms from selected partitions.

**Show fire alarms of partitions** [Fire alarms] – the keypad can signal fire alarms from selected partitions.

**CHIME signal of zones** [Chime zones] – the keypad can audibly signal violation of selected zones.



*In the case of the INTEGRA 256 Plus control panel, violation of zone numbers 129 to 256 will be indicated by the INT-KLFR / INT-TSG / INT-TSG2, INT-TSH, INT-TSH2, INT-TSI keypads and the keypads with firmware version:*

- INT-KLCD / INT-KLCADR – 1.12 (or newer),
- INT-KLCDK / INT-KLCDL / INT-KLCDS – 6.12 (or newer),
- INT-KSG – 2.00 (or newer).

**Zone disabling CHIME** [Chime bps. zone] – zone, which, if violated, will disable the CHIME feature for specified time.



*The zone 256 cannot disable the CHIME feature.*

**Bypass time** [Chime bps. time] – time during which the CHIME signal will be disabled after violation of the zone which disables the signaling (time is counted from the zone restore). If the value 0 is programmed, the signaling will not be disabled.

**Quick Arm partitions** [Quickarm part.] – partitions which will be armed in case of the quick arming (see: USER MANUAL).

**Display entry delay of partitions** [Show entry del.] – information on entry delay countdown in selected partitions can be displayed on the keypad.

**Display exit delay of partitions** [Show exit delay] – information on exit delay countdown in selected partitions can be displayed on the keypad.

**Signal entry delay of partitions** [Sign.entry del.] – the entry delay countdown in selected partitions can be audibly signaled on the keypad.

**Signal exit delay of partitions** [Sign.exit delay] – the exit delay countdown in selected partitions can be audibly signaled on the keypad.

**Date/Time format** – the format in which the date and time are to be displayed on the keypad.

**LCD backlight** – selection of the display backlighting type.

**Keys backlight** – selection of the keypad backlighting type.

## Alarm messages

**Partitions** [Part.al.msg.] – if this option is enabled, messages on partition alarms will be displayed (they contain the name of partition).

**Zones** [Zone al.msg.] – if this option is enabled, messages on alarms from zones will be displayed (they contain the name of zone). The zone alarm messages have the priority.

## Alarms

**FIRE** [Fire alarm] – if this option is enabled, pressing the  key for approx. 3 seconds will trigger the fire alarm.

**PANIC** [Panic alarm] – if this option is enabled, pressing the  key for approx. 3 seconds will trigger the panic alarm.

**AUX.** [Medical alarm] – if this option is enabled, pressing the  key for approx. 3 seconds will trigger the medical alarm.

**3 wrong codes** [3 wrong codes] – if this option is enabled, entering incorrect code three times will trigger the alarm.

**LCD keypad, addr.:00**

version: ----

**Keypad** | **Volume/filter** | **State inspections** | **User functions definition**

Name:

Date/Time format:

LCD backlight:

keys backlight:

Alarm messages  
 Partitions  Zones

Alarms  
 FIRE  PANIC  
 AUX.  3 wrong codes

Additional options  
 Silent PANIC alarm  
 Sign. entry delay  
 Sign. exit delay  
 Sign. alarms  
 Keys sound  
 Sign. trbl in part. arm  
 Sign. new trouble  
 Show code entering  
 Show keypad name  
 Exit delay clearing enable  
 Show viol. zones  
 Auto-Arm delay countdown  
 Displ. mode switching  
 Show disarm messages  
 Show arm messages  
 **Communication RS**  
 Quick control

Partitions managed by keypad:  

1	2	3	4	5	6	7	8	9	10	11	12	13	14	15	16
17	18	19	20	21	22	23	24	25	26	27	28	29	30	31	32

Show alarms of partitions:  

1	2	3	4	5	6	7	8	9	10	11	12	13	14	15	16
17	18	19	20	21	22	23	24	25	26	27	28	29	30	31	32

Show fire alarms of partitions:  

1	2	3	4	5	6	7	8	9	10	11	12	13	14	15	16
17	18	19	20	21	22	23	24	25	26	27	28	29	30	31	32

CHIME signal of zones:  

1	2	3	4	5	6	7	8	9	10	11	12	13	14	15	16
17	18	19	20	21	22	23	24	25	26	27	28	29	30	31	32
33	34	35	36	37	38	39	40	41	42	43	44	45	46	47	48
49	50	51	52	53	54	55	56	57	58	59	60	61	62	63	64
65	66	67	68	69	70	71	72	73	74	75	76	77	78	79	80
81	82	83	84	85	86	87	88	89	90	91	92	93	94	95	96
97	98	99	100	101	102	103	104	105	106	107	108	109	110	111	112
113	114	115	116	117	118	119	120	121	122	123	124	125	126	127	128

Zone disabling chime:  Bypass time:

Quick Arm partitions:  

1	2	3	4	5	6	7	8	9	10	11	12	13	14	15	16
17	18	19	20	21	22	23	24	25	26	27	28	29	30	31	32

Display entry delay of partitions:  

1	2	3	4	5	6	7	8	9	10	11	12	13	14	15	16
17	18	19	20	21	22	23	24	25	26	27	28	29	30	31	32

Display exit delay of partitions:  

1	2	3	4	5	6	7	8	9	10	11	12	13	14	15	16
17	18	19	20	21	22	23	24	25	26	27	28	29	30	31	32

Signal entry delay of partitions:  

1	2	3	4	5	6	7	8	9	10	11	12	13	14	15	16
17	18	19	20	21	22	23	24	25	26	27	28	29	30	31	32

Signal exit delay of partitions:  

1	2	3	4	5	6	7	8	9	10	11	12	13	14	15	16
17	18	19	20	21	22	23	24	25	26	27	28	29	30	31	32

Zone 113: "Zone 113"  
 in LCD keypad  
 Not used

Zone 114: "Zone 114"  
 in LCD keypad  
 Not used

Auto-backlight  
 Entry delay in part.:   viol. of zone:   no

Tamper signaled in part.:

Comments:

Fig. 8. Example of LCD keypad settings.

## Additional options

**Silent PANIC alarm** [Silent panic] – if this option is enabled, the panic alarm triggered from the keypad will be a silent one, i.e. the keypad will not indicate it, there will be no audible signal, but the alarm will be reported to the monitoring station. The silent panic alarm is useful when the control panel is sending events to the monitoring station, but unauthorized persons should not be aware of the alarm being triggered. This option is available when the PANIC option is enabled.

**Sign. alarms** [Alarm signal.] – with this option enabled, the keypad will signal the alarms audibly.

**Key sounds** [Key sounds] – with this option enabled, pressing the keypad keys is confirmed by beeps.

**Sign. trbl. in part. arm** [Trbl.in p.arm.] – if this option is enabled, the  LED goes off after all managed by keypad partitions are armed (if the option is disabled, the LED goes off after just one of the partitions is armed).

**Sign. new trouble** [New trbl.sign.] – with this option enabled, the keypad can audibly signal the occurrence of a new trouble (if the TROUBLE MEMORY UNTIL REVIEW option is enabled). New trouble signaling is cleared after the troubles have been reviewed by the user.

**Show code entering** [Show code ent.] – with this option enabled, entering the code is presented on the keypad display by asterisks.

**Show keypad name** [Name (2nd row)] – with this option enabled, the keypad name is presented in the lower line of the display.

**Exit delay clearing enable** [Fin.exit delay] – with this option enabled, the exit delay time in partitions with the EXIT DELAY CLEARING option enabled can be shortened after pressing in turn the 9# keys.

**Show viol. zones** [Zone violation] – with this option enabled, violating the CHIME signal triggering zone result additionally in the zone name being displayed.

**Auto-Arm delay countdown** [Auto-arm delay] – with this option enabled, the auto-arm delay countdown in partition is signaled acoustically.

**Displ. mode switching** [Dspl.mode chg.] – with the option enabled, you can toggle the display between the standby mode and the partition status display mode by using the 9 key.

**Show disarm messages** [Show disarming] – if this option is enabled, the keypad displays the disarming message irrespective of how the system has been disarmed. If this option is disabled, the keypad displays the disarming message only when the system has been disarmed from this keypad.

**Show arm messages** [Show arm] – if this option is enabled, the keypad displays the arming message. If this option is disabled, the arming message is not displayed.

**Communication RS** – if this option is enabled, it is possible to connect a computer with GUARDX program to the LCD keypad RS-232 port.

**Quick control** [Control (8#)] – if this option is enabled, the OUTS CONTROL user function can be started by pressing in turn the 8# keys (without the need to enter the user code).

## Zones

**in LCD keypad** – if you select this option, the keypad zone will be supported.

**Not used** – if you select this option, the keypad zone will not be supported.

## Auto-backlight

**Entry delay in part.** – if you select this option, the backlight will be additionally turned on when the entry delay countdown begins in a selected partition.

**viol. of zone** – if you select this option, the backlight will be additionally turned on when a selected zone is violated.

**no** – if you select this option, the backlight will be turned on only when the user presses any button.

**i** | *In the case of the INTEGRA 256 Plus control panel, violation of the zone numbers from 129 to 256 can turn on backlight in the INT-KLFR / INT-TSG / INT-TSG2, INT-TSH, INT-TSH2 keypads and keypads with the following firmware version:*

- INT-KLCD / INT-KLCADR – 1.12 (or newer),
- INT-KLCDK / INT-KLCDL / INT-KLCDS – 6.12 (or newer),
- INT-KSG – 2.00 (or newer).

**Tamper signaled in part.** [Tamper in part.] – partition where alarm will be triggered in the event of keypad tamper, triggering the alarm from keypad etc.

### 7.1.2 Volume/filter

**i** | *You can adjust the volume level for INT-KLCD, INT-KLCADR and INT-KLFR keypads.*

**Volume** – volume level of the beeps generated during keypad operation (key pressing, confirmation of performed operation, etc.).

**Volume – chime** – volume level of the beeps generated after zone violation (CHIME).

**Volume – entry delay** – volume level of the entry delay beeps.

**Volume – exit delay** – volume level of the exit delay beeps.

**Volume – fire** – volume level of the fire alarm beeps.

**Volume – alarm** – volume level when signaling burglar, panic and medical alarms.

**Card reader filter** [Sensitivity] – the level of signal filtering by the proximity card reader (when programming from the keypad: 1 – minimal filtering, 10 – maximal filtering). Higher filtering level is useful where noise occurs, causing the reader to malfunction. This parameter is available for the INT-KLCADR keypad with firmware version 1.06 (or newer) and for other keypads provided with a built-in reader.

### 7.1.3 State inspections

#### Key hold-down

Some functions can be run by the users without having to enter the code.

**1 – zone state** [Zones] – if this option is enabled, the user can press and hold down the key with number 1 for 3 seconds to check the state of zones.

**4 – partitions armed** [Partitions] – if this option is enabled, the user can press and hold down the key with number 4 for 3 seconds to check the state of partitions.

**5 – alarm events memory** [Alarms log] – if this option is enabled, the user can press and hold down the key with number 5 for 3 seconds to view the alarms log (based on the event log).

**6 – trouble memory** [Troubles log] – if this option is enabled, the user can press and hold down the key with number 6 for 3 seconds to view the troubles log (based on the event log).

- 7 – trouble status** [Troubles] – if this option is enabled, the user can press and hold down the key with number 7 for 3 seconds to view the troubles.
- 8 – chime on/off** [Chime changing] – if this option is enabled, the user can press and hold down the key with number 8 for 3 seconds to enable / disable the CHIME signal in the keypad.

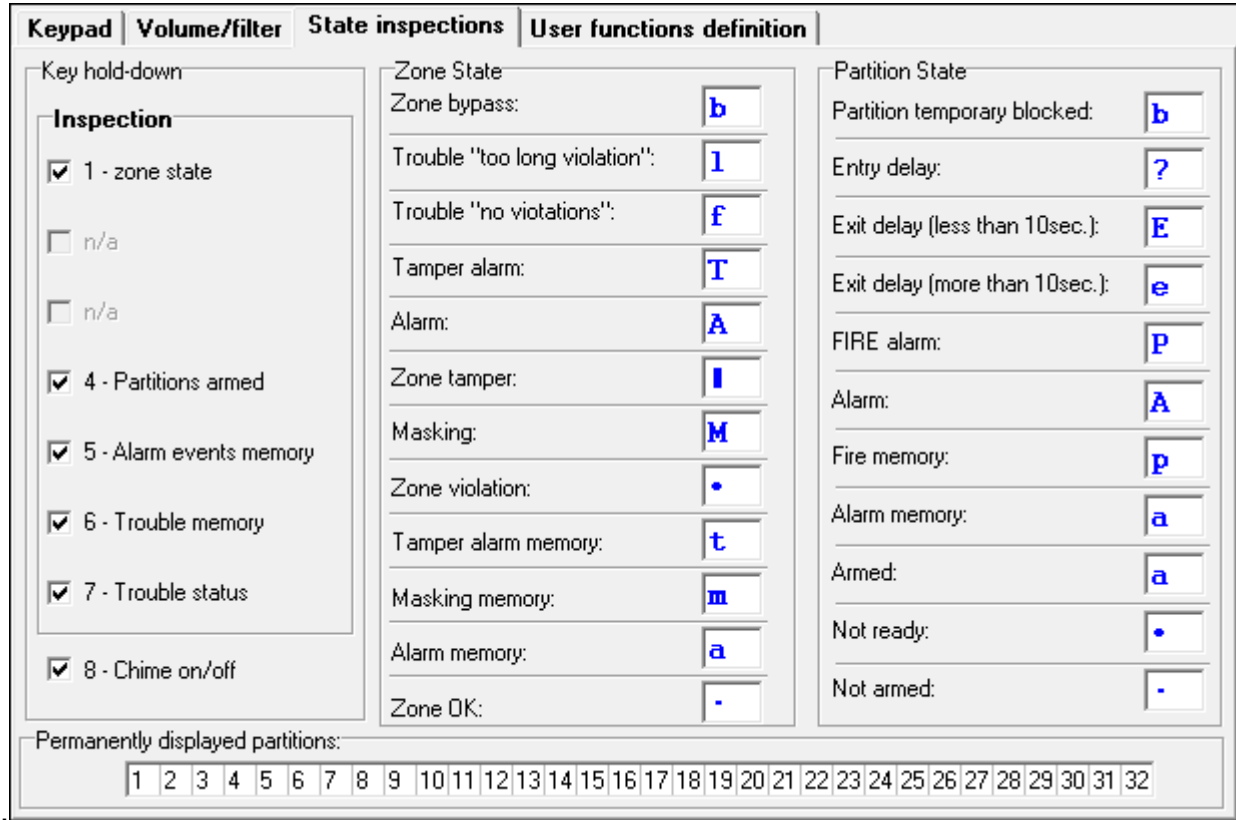

Fig. 9. Keypad “State inspections” tab in DLOADX program.

**Zone state** [Zone characters]

You can define the symbols which will be used to illustrate the state of zones on the display.

**Partition state** [Part.characters]

You can define the symbols which will be used to illustrate the state of partitions on the display.

**Permanently displayed partitions** [State part.]

You can select the partitions whose state will be permanently presented in the lower line of the display. Up to 16 partitions can be selected. The partitions are displayed successively: for example, if the partitions 3, 6 and 7 are selected, their state will be displayed in the first, second and third position of the display.

**7.1.4 User functions definition**

**Code+arrows** – you can define which functions will be started on entering the code and pressing the selected arrow key.

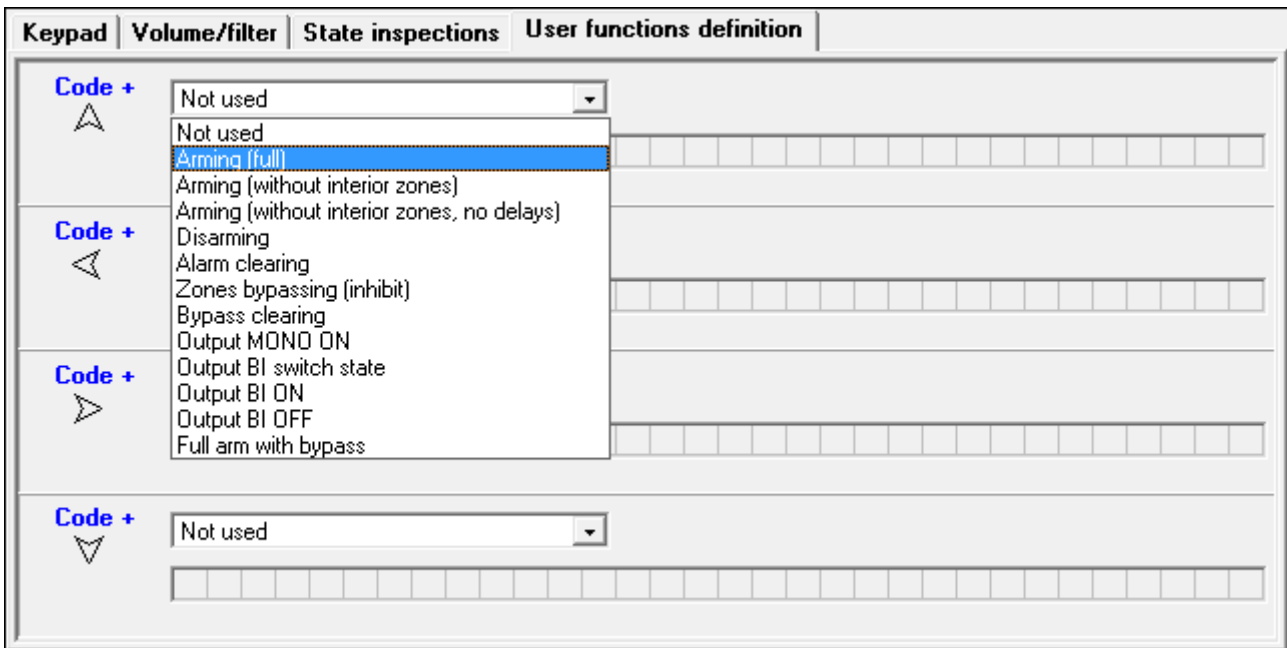

Fig. 10. "User functions definition" tab for keypad in the DLOADX program.

### 7.1.5 Proximity cards

Proximity card handling parameters are available for the keypads provided with proximity card readers (INT-KLCDR and INT-KLFR).

#### Card function

**Card read** [Card close] – you can select the function executed after presenting the card.

**Card holddown** [Card close long] – you can select the function executed after holding the card.

**Door** [Door to open] – if presenting the card or holding it is to open a door, you must indicate the door supervised by the access control module or the 101. CARD READ – EXPANDER type output.

#### Wrong card

**Signal on wrong card** [Unkn.card sig.] – if this option is enabled, reading in an unknown card will be signaled by two long beeps.

**Event after 3 readings** [Ev.3 unk.cards] – if this option is enabled, reading in an unknown card three times will save the event.

**Alarm after 3 readings** [Al.3 unk.cards] – if this option is enabled, reading in an unknown card three times will trigger an alarm. The option is available, if the EVENT AFTER 3 READINGS option is enabled.

#### Code+card

**Code OR card** – the user can use code or card for authentication.

**Code AND card** – the user must use code and card for authentication.

**Follow output** – the authentication method depends on the status of selected output (the output active – code and card; the output inactive – code or card).



*In case of the authentication using code and card, the executed function depends on the second identifier.*

*THE OUTPUTS 255 AND 256 CANNOT BE USED FOR CONTROLLING THE AUTHENTICATION METHOD.*

## 8. Timers

---

The timers enable some functions to be automatically executed by the control panel (arming/disarming, turning on/off devices connected to outputs, etc.). The timer compares the time to that of the control panel clock and executes the selected function at the programmed time.

### 8.1 Programming the timers

---

The timers can be programmed:

- using the keypad, in the service mode, by means of the functions available in the TIMERS submenu,
- using the DLOADX program, in the “Timers” window.

### 8.2 Timer parameters

---

**Name** – individual timer name (up to 16 characters).

**User edits** – if this option is enabled, the users can edit the timer parameters by using the keypad ([code]\* ►CHANGE OPTIONS ►TIMERS).



*Parameters of the timers indicated as the controlling ones for the 120. THERMOSTAT type output can be edited by the user even if the USER EDITS option is disabled (see: “120. Thermostat output settings” p. 66).*

**[day of week]** – you can program the timer start/end time for each day of the week.

**Everyday** – you can program the timer start/end time which will apply to those days of the week for which no timer start/end time has been programmed.

**Exception** – the period during which the timer will be started/ended at a different time. 4 exceptions can be programmed for a timer. You can program for each exception:

- the date from which the exception will apply,
- the date to which the exception will apply,
- the timer start/end time when an exception applies.



*If a year is programmed for an exception, the setting will only be valid for the current year. If no year is programmed (the 9999 sequence is entered in the keypad instead of the year), the exception will be valid every year.*

**Arming mode** – the arming mode which will be activated when the timer starts (in the DLOADX program, enter an additional digit next to the timer start time: 0 – full arming; 1 – full arming + bypasses; 2 – arming without interior; 3 – arming without interior and without entry delay).

## 9. User schedules

---

User schedules should be defined for the needs of the SCHEDULE type users (see: USER MANUAL). You can program the user schedules:

- using the keypad, in the service mode, by means of the functions available in the USER SCHEDULES submenu,
- using the DLOADX program, in the “Timers” window, “User Schedules” tab.

For each user schedule, you can:

- program an individual name (up to 16 characters),
- indicate the timers which will determine when the user will have access to the system.

## 10. Reporting

The control panel can send event codes to the monitoring station using the following transmission paths:

- analog telephone line,
- Ethernet (connection of the ETHM-1 Plus / ETHM-1 module to the control panel required),
- cellular data network (INT-GSM / INT-GSM LTE module must be installed in the alarm system or SATEL GSM module must be connected to the control panel),
- SMS (INT-GSM / INT-GSM LTE module is required to be installed in the alarm system) – the control panel gets no acknowledgement of event code receipt.

The control panel will try to send event code to the monitoring station using in turn:

1. ETHM-1 Plus / ETHM-1 module and/or INT-GSM / INT-GSM LTE module. If several such modules are connected to the control panel, that with the lowest address will be used. Event code can be sent via Ethernet, cellular data network or SMS.



*When configuring the ETHM-1 Plus module to which the INT-GSM / INT-GSM LTE module is connected, or when configuring the INT-GSM / INT-GSM LTE module connected directly to the control panel, define priority of the transmission paths. The transmission path which is not included in the list defining the priority of transmission paths, will not be used.*

2. SATEL GSM module for transmission via the cellular data network (GPRS/LTE).
3. analog telephone line (basic and backup telephone number).

If the event code is successfully sent via one transmission path, the other transmission paths will not be used.

If sending the event code via one transmission path fails, the control panel will try to send the event code by using the next transmission path. In the case of reporting via the telephone line, if the event cannot be sent despite completion of the preprogrammed number of retries, the control panel will hang up until a next event occurs, or for a specified period of time. After the time expires, the control panel will make further attempts to send the event.

The reporting parameters can be programmed:

- using the keypad, in the service mode, by means of the functions available in the MONITORING submenu,
- using the DLOADX program, in the “Reporting” window.

For correct operation, the reporting function may require enabling some system options.

Reporting through the ETHM-1 Plus / ETHM-1 / INT-GSM / INT-GSM LTE / GSM modules requires that some telephone options be enabled and settings of these modules properly configured.

Before you proceed to the programming, obtain from the monitoring station operator all data necessary to correctly start the reporting function:

- depending on the method of sending events:
  - telephone number of the monitoring station (telephone reporting),
  - server address, port number, STATION KEY and KEY (ETHM) (reporting through Ethernet network),
  - server address, port number, STATION KEY and KEY (GPRS) (reporting via the cellular data network),
  - telephone number of the monitoring station and SMS message format (SMS reporting),
- transmission format required by the monitoring station,
- identifiers assigned to the alarm system,

- list of event codes (not applicable to Contact ID and SIA formats).

## 10.1 Reporting parameters and options

---

See also section “Telephone options” p. 69.

Shown in square brackets are the names used in keypads.

### 10.1.1 Options

**Station 1 or Station 2** – the control panel will make an attempt to send the event code to station 1 and, if unsuccessful, to station 2.

**Station 1 only** – the event codes are only sent to station 1.

**Station 2 only** – the event codes are only sent to station 2.

**Station 1 and 2** – the event codes are sent to both stations. For most formats, it is possible then to define which events will be sent to the given station (see: EVENTS ASSIGNMENT).

**Dual path reporting** – the option is available when the ETHM-1 Plus module with the INT-GSM / INT-GSM LTE module attached to it is connected to the control panel. The control panel will make an attempt to send the event code to station 1 and, if unsuccessful, to station 2.



*The dual path reporting requires that the following settings be additionally programmed:*

just one transmission path for Station 1: ETHM (Ethernet) [settings of the ETHM-1 Plus module with the INT-GSM / INT-GSM LTE module connected to it],

priority transmission path for Station 2: GPRS SIM1 or GPRS SIM 2 [settings of the ETHM-1 Plus module with the INT-GSM / INT-GSM LTE module connected to it],

IP format for both stations: SIA-IP,

supervision of the link between the control panel and the central station: SUPERVISION INTERVAL parameter configured at least for the first monitoring station.

**No module restart reports** [No rest. mon.] – when this option is enabled and the Contact ID or SIA format is used for reporting, no event codes referring to module restarts will be sent to the monitoring station.

### Advanced

**Long kiss-off signal** – with this option enabled, the control panel will accept a long kiss-off (acknowledgment) signal for receiving events in case of Ademco Express and Contact ID formats. Enable this option in the event of telephone reporting if the monitoring station acknowledges receiving events in a non-standard way (the kiss-off signal is longer than 800 ms).

**Longer waiting for initial handshake** – with this option enabled, the control panel will wait longer for handshake from the monitoring station in case of sending events in the Ademco Express, Contact ID or SIA format. Enable this option in the event of telephone reporting, if the monitoring station sends a non-standard initial handshake.

**Identifier confirmation required** – the option refers to the SIA format. If it is enabled, the control panel waits for acknowledgement by the monitoring station of receiving the identifier with which the data were sent. The option refers to the telephone reporting.

**6-character identifier** – the option refers to the SIA format. If it is enabled, events will be sent with a 6-character identifier. It consists of 2 parts: 2-character prefix and 4-character identifier.

**Send event source name** – the option refers to the SIA format. If it is enabled, the name of event source (zone, user, etc.) will also be sent along with the event code.

**Send event partition name** – the option refers to the SIA format. If it is enabled, the name of partition where the event occurred will also be sent along with the event code.

**Each data block conf. required** – the option refers to the SIA format. If it is enabled, the control panel waits for acknowledgement by the monitoring station of receiving each data block. The option refers to the telephone reporting.

**Extended charset** – the option refers to the SIA format. If it is enabled, not only ASCII characters, but also national characters can be sent.

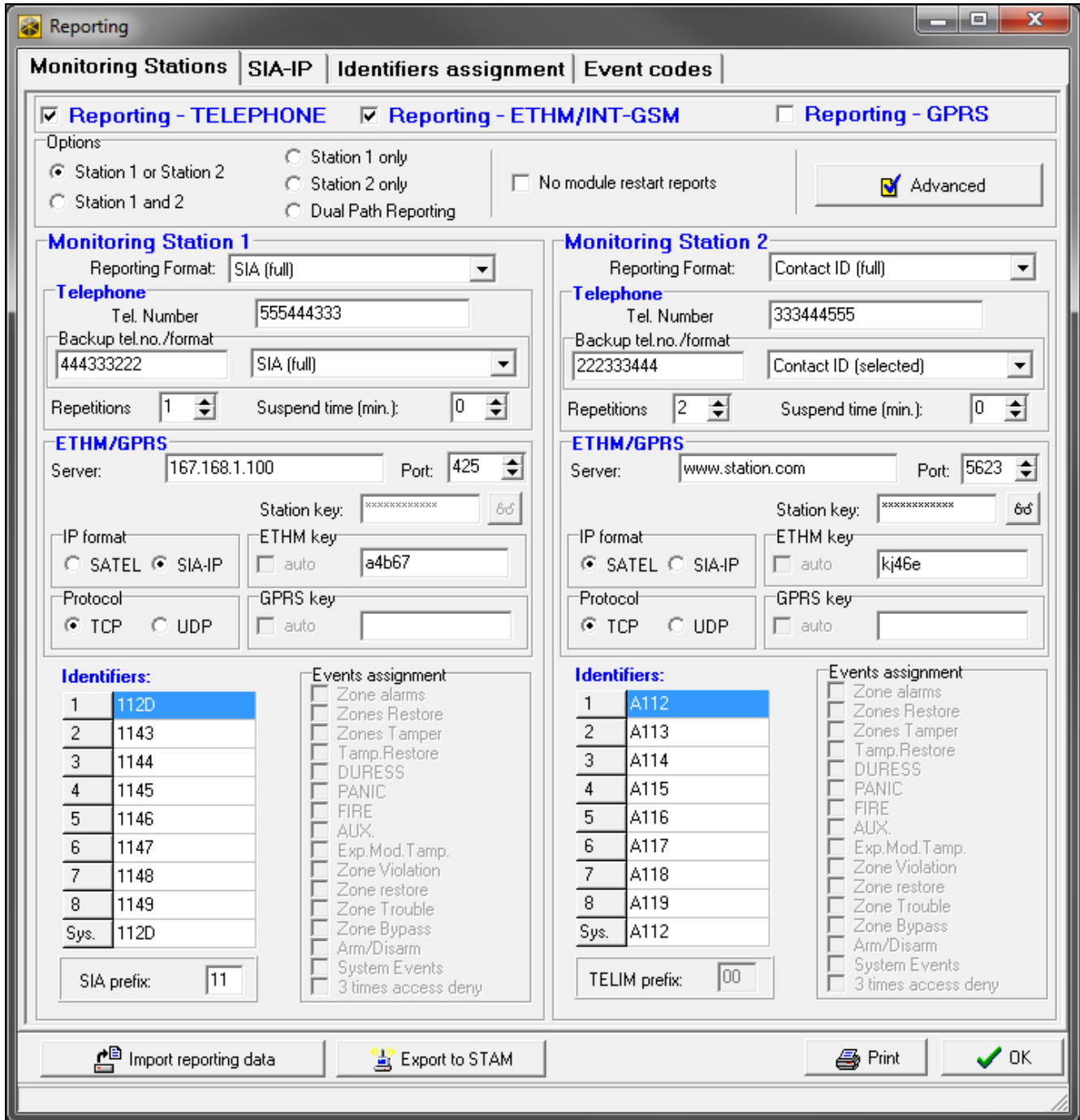

Fig. 11. Example of reporting settings in the DLOADX program.

### 10.1.2 Monitoring station 1 / Monitoring station 2

**Reporting format [Tel. 1 format]** – format in which event codes are sent to the monitoring station.

**i** | *Having selected the CONTACT ID (FULL) or SIA (FULL) format you do not need to program the assignment of identifiers and any event codes. The control panel will send*

*the codes according to the format specification and the performed subdivision into objects.*

*In the TELIM format, events can only be sent via the analog telephone line.*

## Telephone

**Tel. number** [Tel. 1 number] – basic telephone number of the monitoring station.

**Backup tel. no.** [Tel. 2 number] – a backup telephone number of the monitoring station. The control panel will make an attempt of reporting to that telephone number, if the attempt of reporting to the basic telephone number fails.

**Backup format** [Tel. 2 format] – format in which event codes are sent to the backup telephone number of the monitoring station.

**Repetitions** [Repetition count] – the number of attempts to establish telephone connection with the monitoring station after which, if there is no connection (busy number, no answer from the station, etc.), the control panel will suspend reporting. Up to 31 retries can be programmed. Programming the value 0 means that monitoring will be suspended after 8 attempts.

**Suspend time** – the time for which telephone reporting is suspended, after making the programmed number of attempts to establish connection with the monitoring station. The control panel will resume the attempt of establishing telephone connection with the monitoring station after this time expires or a next, new event occurs. Up to 30 minutes can be programmed. Programming the value 0 means that an attempt to establish telephone connection with the monitoring station will only be taken after occurrence of a new event in the system.

## ETHM/GPRS

**Server** [IP address] – the address of STAM-2 monitoring station (or SMET-256 converter). It can be entered in the form of IP address (4 decimal numbers separated by dots) or as a name.

**Port** – the number of port through which communication with the monitoring station will be effected.

**Station key** [Key (MS)] – the key with which the data sent to the monitoring station will be encrypted (a string of up to 12 alphanumeric characters). The parameter applies to the IP SATEL format.

**IP format** [SIA-IP] – if the event codes are to be sent via Ethernet or cellular data network, specify whether SATEL format or SIA-IP format (SIA DC-09 standard) will be used.

**Protocol** [UDP] – if the event codes are to be sent via Ethernet or cellular data network, specify whether TCP or UDP protocol will be used.

**ETHM key** [Key (ETHM)] – the string of up to 5 alphanumeric characters intended to identify the control panel for the purposes of reporting via Ethernet. The parameter applies to the IP SATEL format.

**GPRS key** [Key (GPRS)] – the string of up to 5 alphanumeric characters intended to identify the control panel for the purposes of reporting via the cellular data network (GPRS/LTE). The parameter applies to the IP SATEL format.



*It is recommended that the maximum number of characters be programmed for the keys and that letters, digits and special characters be used, as this will ensure higher security of the transmission.*

## Identifiers

Each event code is sent to the monitoring station with an identifier. Up to 8 identifiers plus a system identifier can be programmed. Sent with the system identifier are events related to the alarm system (troubles, tests, etc.).

4 characters (digits or letters from A to F) must be programmed for each identifier. Using the digit 0 in the identifier is not recommended.

For the pulse, ADEMCO EXPRESS, CONTACT ID (SELECTED) or SIA (SELECTED) formats, you must define which events will be sent with the given identifier (see: "Identifiers assignment").

**i** | *For the CONTACT ID (FULL) or SIA (FULL) formats, each object has its own identifier. Therefore, the identifiers of non-existing objects need not to be programmed. In the system event identifier field, you should re-enter the identifier of the object which is responsible for the system (for example, the object, where the control panel is installed).*

## SIA / TELIM prefix

2 characters which will precede each of the identifiers in case of the SIA and TELIM formats. Thus an identifier consisting of 6 characters can be obtained. 2 hexadecimal characters (digits or letters from A to F) can be programmed. Entering 00 means that the prefix will not be added. Using the digit 0 in the prefix is not recommended.

## Events assignment

If the events are to be sent to both stations (STATION 1 AND 2 is selected), you can define which event types will be reported to the given station.

**i** | *It is not possible to assign events for the CONTACT ID (FULL) and SIA (FULL) formats.*

### 10.1.3 SIA-IP

If events are to be sent in the SIA-IP format, you must program additional parameters for each monitoring station.

**Send MAC address** [MAC] – if this option is enabled, the MAC address of ETHM-1 / ETHM-1 Plus module will be sent with event code.

**Send timestamp** [Timestamp] – if this option is enabled, the date and time will be sent with event code (the monitoring station can change the date and time in the control panel).

**Encrypt data** [Coded] – if this option is enabled, the data to be sent will be encrypted, and the date and time will be sent with event code (the monitoring station can change the date and time in the control panel).

**SIA-IP key** – the key to encrypt data to be sent using the SIA-IP format.

**hex** – if the option is enabled, you can enter up to 32 hexadecimal characters as the SIA-IP KEY. If the option is disabled, you can enter up to 16 alphanumeric characters as the SIA-IP KEY.

**SIA-IP acct** – a string of up to 16 hexadecimal characters, which is used to identify the control panel for the purpose of reporting in SIA-IP format.

**Supervision interval** [SIA-IP test] – an additional transmission can be sent at specified intervals to check communication with the monitoring station. You can program a number of days, hours, minutes and seconds between the transmissions.

**Event-independent pooling** [Ev.independent] – if this option is enabled, an additional transmission to check communication is sent after the programmed time has elapsed since the last such transmission. If this option is disabled, an additional transmission to check communication is sent after the programmed time has elapsed since any last transmission.

### 10.1.4 Identifiers assignment

Define the identifier with which events relating to individual partitions, zones, keypads and expansion modules will be sent. If no identifier is assigned to the given element of the system, it will be impossible to define codes for events relating to it.

### 10.1.5 Event codes

For the pulse and Ademco Express formats, it is necessary to program codes which will be reported to the monitoring station if the defined events occur. The reported events are those for which a code different from "00" has been programmed. 2 hexadecimal characters (digits or letters from A to F) are to be programmed.



*In case of the CONTACT ID (SELECTED) and SIA (SELECTED) formats, indicate the events which are to be reported, entering for them any code different from "00" (a code consistent with the format specification will be sent, not the entered one). The events for which the "00" code has been programmed will not be reported.*

### 10.1.6 Test transmissions

The test transmission may be sent:

- at a specified time. The test transmission code will be sent regularly at a defined time. The number of days between transmissions and the time of sending transmission are programmed.
- in specified time intervals. For each monitoring station, the number of days, hours and minutes between transmission can be individually programmed. The test transmission code will be sent:
  - after a predefined period of time has elapsed since the last transmission, irrespective of whether it was a test transmission, or the code of another event was sent (the NO SYNC. TO LAST TRANSMISSION option disabled),
  - at predefined time intervals (the NO SYNC. TO LAST TRANSMISSION option enabled).

## 10.2 Starting the reporting

---

### 10.2.1 Telephone reporting

1. Enable the REPORTING – TELEPHONE option.
2. Using the telephone options (see: "Telephone options" p. 69):
  - determine how the telephone numbers should be dialed (TONE DIALING option and – in case of the pulse dialing – PULSE DIALING 1/1,5 (OFF:1/2) option),
  - determine whether the control panel, prior to dialing the number, should check the telephone line for dialing signal (NO DIAL TONE TEST option).
3. Determine whether the event codes will be sent to both monitoring stations or to one of them only (STATION 1 OR 2 / STATION 1 / STATION 2 / STATION 1 AND 2).
4. Program the following for the monitoring station to which event codes are to be sent:
  - telephone number,
  - reporting format in which the codes will be sent,
  - the number of attempts to connect to the station after which, if there is no connection, the control panel will suspend reporting (REPETITIONS),
  - time for which reporting will be suspended after the programmed number of attempts to establish connection with the station has been made (SUSPEND TIME),
  - identifiers with which the events will be sent,
  - events assignment (if STATION 1 AND 2 is selected),
  - advanced options (if Ademco Express, Contact ID, SIA or TELIM format is selected).

5. If a reporting format other than CONTACT ID (FULL) or SIA (FULL) is selected:
  - assign identifiers to the partitions, zones, keypads and expansion modules,
  - program the codes for events which are to be reported.
6. Define the parameters of test transmissions.

### 10.2.2 Reporting via Ethernet network



*The ETHM-1 / ETHM-1 Plus module must be connected to the control panel.*

*Events in TELIM format cannot be sent through Ethernet network.*

1. Enable the REPORTING - ETHM-1 / REPORTING – ETHM/INT-GSM option.
2. Determine whether the event codes will be sent to both monitoring stations or to one of them only (STATION 1 OR 2 / STATION 1 / STATION 2 / STATION 1 AND 2). If the INT-GSM / INT-GSM LTE module is connected to the ETHM-1 Plus module, you can select the DUAL PATH REPORTING option.
3. Program the following for the monitoring station to which event codes are to be sent:
  - reporting format in which the codes will be sent,
  - server address,
  - port number,
  - IP format in which the codes will be sent (SATEL or SIA-IP),
  - encryption key (STATION KEY) and control panel identifier for the purposes of reporting via Ethernet (ETHM KEY) if the SATEL format is selected,
  - additional parameters if the SIA-IP format is selected,
  - identifiers with which the events will be sent,
  - event assignment (if STATION 1 AND 2 is selected),
  - advanced options if SIA reporting format is selected.
4. If a reporting format other than CONTACT ID (FULL) or SIA (FULL) is selected:
  - assign identifiers to the partitions, zones, keypads and expansion modules,
  - program the codes for events which are to be reported.
5. Define the parameters of test transmissions.
6. If the INT-GSM / INT-GSM LTE module is connected to the ETHM-1 Plus module, define the priority of Ethernet reporting in the ETHM-1 Plus module settings.

### 10.2.3 Reporting via cellular data network



*The TELIM format events cannot be sent via the cellular data network.*

*The Internet connection settings (APN, username, password, DNS server) must be programmed in the INT-GSM / INT-GSM LTE / GSM module.*

#### Reporting by using the INT-GSM / INT-GSM LTE module

1. Enable the REPORTING – ETHM/INT-GSM option.
2. Determine whether the event codes will be sent to both monitoring stations or to one of them only (STATION 1 OR 2 / STATION 1 / STATION 2 / STATION 1 AND 2). If the INT-GSM / INT-GSM LTE module is connected to the ETHM-1 Plus module, you can select the DUAL PATH REPORTING option.
3. Program the following for the monitoring station to which event codes are to be sent:
  - reporting format in which the codes will be sent,
  - server address,
  - port number,
  - IP format in which the codes will be sent (SATEL or SIA-IP),

- encryption key (STATION KEY) and control panel identifier for the purposes of reporting via Ethernet (ETHM KEY) if the SATEL format is selected,
  - additional parameters if the SIA-IP format is selected,
  - identifiers with which the events will be sent,
  - event assignment (if STATION 1 AND 2 is selected),
  - advanced options if SIA reporting format is selected.
4. If a reporting format other than CONTACT ID (FULL) or SIA (FULL) is selected:
    - assign identifiers to the partitions, zones, keypads and expansion modules,
    - program the codes for events which are to be reported.
  5. Define the parameters of test transmissions.
  6. Define the priority of reporting via the cellular data network in the settings of INT-GSM / INT-GSM LTE module (INT-GSM / INT-GSM LTE module connected to the control panel) or ETHM-1 Plus module (INT-GSM / INT-GSM LTE module connected to the ETHM-1 Plus module).

### Reporting by using the GSM module



*As an external modem, the following module must be connected to the control panel (the RS-232 ports of control panel and module must be connected):*

- GSM-X / GSM-X LTE,
- GSM LT-2 with firmware 2.11 (or later),
- GSM-4 with firmware 4.11 (or later),
- GSM-5.

*If the GSM module is only connected to the control panel dialer terminals (TIP and RING), the settings of the reporting via cellular data network will be ignored.*

*The EXTERNAL MODEM and MODEM ISDN/GSM/ETHM options must be enabled in the control panel (see: "Telephone options" p. 69).*

1. Enable the REPORTING – GPRS option.
2. Determine whether the event codes will be sent to both monitoring stations or to one of them only (STATION 1 OR 2 / STATION 1 / STATION 2 / STATION 1 AND 2).
3. Program the following for the monitoring station to which event codes are to be sent:
  - reporting format in which the codes will be sent,
  - server address,
  - port number,
  - IP format in which the codes will be sent (SATEL or SIA-IP),
  - encryption key (STATION KEY) and control panel identifier for the purposes of reporting via the cellular data network (GPRS KEY) if the SATEL format is selected,
  - additional parameters if the SIA-IP format is selected,
  - identifiers with which the events will be sent,
  - event assignment (if STATION 1 AND 2 is selected),
  - advanced options if SIA reporting format is selected.
4. If a reporting format other than CONTACT ID (FULL) or SIA (FULL) is selected:
  - assign identifiers to the partitions, zones, keypads and expansion modules,
  - program the codes for events which are to be reported.
5. Define the parameters of test transmissions.

## 10.2.4 SMS reporting



*The TELIM format events cannot be sent as SMS messages.*

1. Enable the REPORTING – ETHM/INT-GSM option.
2. Determine whether the event codes will be sent to both monitoring stations or to one of them only (STATION 1 OR 2 / STATION 1 / STATION 2 / STATION 1 AND 2).
3. Program the following for the monitoring station to which event codes are to be sent:
  - reporting format in which the codes will be sent,
  - server address (this address will not be used, but entering some character is required),
  - identifiers with which the events will be sent,
  - event assignment (if STATION 1 AND 2 is selected),
4. If a reporting format other than CONTACT ID (FULL) or SIA (FULL) is selected:
  - assign identifiers to the partitions, zones, keypads and expansion modules,
  - program the codes for events which are to be reported.
5. Define the parameters of test transmissions.
6. In the settings of the INT-GSM / INT-GSM LTE module (INT-GSM / INT-GSM LTE module connected to the control panel) or ETHM-1 Plus module (INT-GSM / INT-GSM LTE module connected to the ETHM-1 Plus module):
  - specify the priority of the SMS reporting,
  - program the telephone number to which the SMS messages will be sent,
  - configure the SMS message format.

## 11. Messaging

---

The control panel can inform the users about the system events by means of:

- voice messages. You must connect to the control panel:
  - the INT-VG module or another voice synthesizer,
  - telephone line or SATEL GSM module.
- voice messages (the INT-VG module or another voice synthesizer must be connected),
- PAGER type text messages, whose content can be programmed (the SATEL GSM modules enable the PAGER messages to be converted into SMS). Connection of telephone line or SATEL GSM module to the control panel is required.
- SMS messages, whose content is created automatically, based on descriptions from the control panel event log memory. The INT-GSM / INT-GSM LTE module must be installed in the system or the SATEL GSM module must be connected to the control panel (RS-232 ports of control panel and module must be connected).



*The required SATEL GSM module:*

- GSM-X / GSM-X LTE,
- module with LEON telephone and firmware version:
  - GSM LT-1: 1.14 or newer,
  - GSM LT-2: 2.14 or newer,
  - GSM-4: 4.14 or newer,
  - GSM-5: 5.14 or newer.

- e-mail messages, whose content is created automatically, based on descriptions from the control panel event log memory. The ETHM-1 Plus or INT-GSM / INT-GSM LTE module is required to be connected to the control panel.

Messaging is performed independently from reporting but reporting has the priority. If in the course of messaging some events occur which must be reported to the monitoring station by the control panel, the messaging will be interrupted. The control panel will resume the messaging function after the event codes are reported to the monitoring station.

You can program the messaging:

- using the keypad, in the service mode, by means of the functions available in the submenu,
  - VOICE MESSAGING (voice messaging and PAGER messaging),
  - SMS MESSAGING (SMS messaging using the GSM module),
  - E-MAIL MESSAG. (e-mail messaging).



*You cannot use the keypad to configure the settings of SMS messaging via the INT-GSM / INT-GSM LTE module.*

- using the DLOADX program:
  - in the “Messaging” window (voice, PAGER and SMS messaging via the GSM module),
  - in the “Structure” window, “Hardware” tab, when configuring the module INT-GSM / INT-GSM LTE settings (SMS messaging via the INT-GSM / INT-GSM LTE module),
  - in the “E-mail messaging” window (e-mail messaging).

For the messaging function to work properly, some system options may have to be enabled.

## 11.1 Voice / PAGER messaging parameters and options

---

**See also section “Telephone options” p. 69.**

Shown in square brackets are the names used in keypads.

**Max. redial number for one round** [Repetition cnt.] – the number of attempts to get through after which the control panel will give up messaging for the current round, if it fails to establish connection (the number is busy).

### 11.1.1 Telephone numbers

**Description** – telephone name or description (up to 16 characters).

**Tel. number** – the telephone number to which messaging is effected.

**Mode** – selection of the messaging type for the given telephone number (0 – voice; 1 – PAGER type 1; 2 – PAGER type 2; 3 – PAGER type 3).

**Round count** – the number of attempts made by the control panel to notify the selected telephone number about the event, if the message reception has not been acknowledged. If the value 0 is entered, messaging for the indicated telephone number will be disabled.

**Any code** – with this option enabled, it is possible to acknowledge the voice message reception from the telephone keypad, using any sequence of 4 digits.

**Code** – 4 digits which, when entered from the telephone keypad, will acknowledge reception of the voice message.



*If no code has been programmed to acknowledge receipt of the voice message, nor the ANY CODE option has been enabled, the control panel will recognize receipt of the message as acknowledged when the receiver is picked up after two rings and any sound occurs.*

**User** – if a code has been programmed to acknowledge receipt of the voice message or the ANY CODE option has been enabled, a user can be assigned to the telephone. Thus, if the INT-VG module is connected to the control panel, the user will be automatically granted access to the voice menu after acknowledgement of the voice messaging.

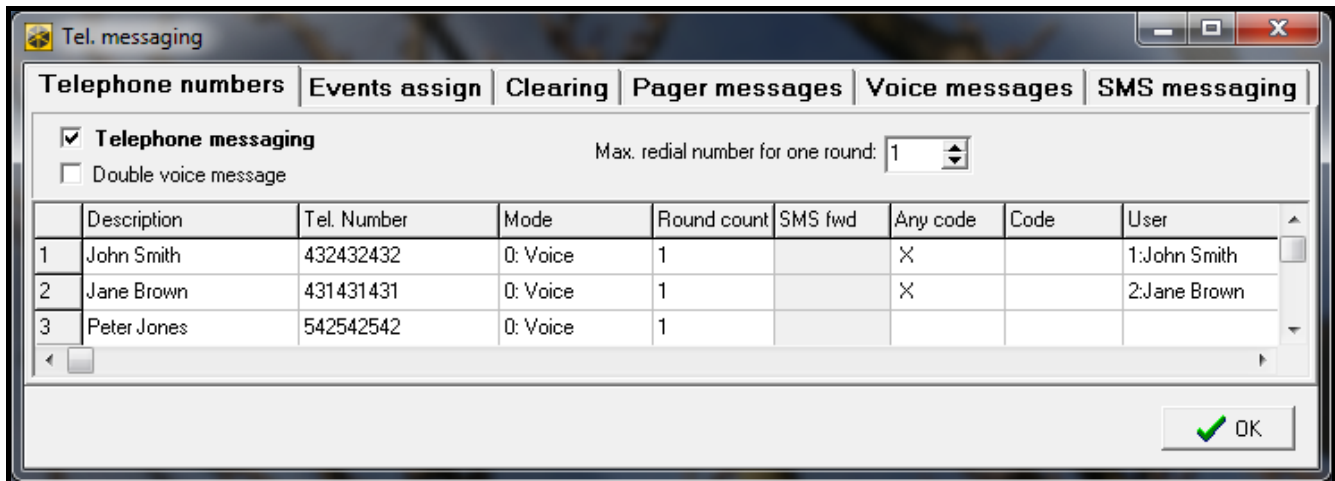

Fig. 12. Example of messaging settings in the DLOADX program.

### 11.1.2 Events assignment

Enter the following information for the events of which the control panel is to notify:

- number of the voice or text message by means of which messaging will be effected,
- telephones which will be notified.

### 11.1.3 Clearing

**In partitions** [Msg.abort in P.]

For each telephone, you can indicate partitions in which clearing an alarm will cancel messaging that alarm (messaging to that telephone number will be canceled, but can be continued to other numbers).

**After acknowledgement** [Msg.abort on T.]

You can indicate telephones which will not be notified about the event, if the control panel receives acknowledgement that the voice message has been received by another, indicated telephone.

### 11.1.4 Pager messages

Define the content of messages which will be used for PAGER type messaging.

### 11.1.5 Pager type

For messaging using the PAGER type messages, you must define the parameters of pager identification. Default parameters of the pager type 1 are adjusted to the SATEL GSM module requirements for conversion of the PAGER type message into SMS message.

## 11.2 SMS messaging parameters and options

The settings described below apply to SMS messaging via the SATEL GSM module. The settings are not available, when the INT-GSM / INT-GSM LTE module is installed in the alarm system. The settings for SMS messaging via the INT-GSM / INT-GSM LTE module are described in the INT-GSM / INT-GSM LTE module manual.

**Name** – individual telephone name (up to 16 characters).

**ON** – if this option is enabled, messaging to the given telephone will be possible.

**Telephone no.** – telephone number which will be notified.

### 11.2.1 Events assignment

Select the types of events which, if occur in the selected partitions, will result in SMS messaging.

## 11.3 E-mail messaging parameters and options

---

**Email address** – e-mail address to which event notifications will be sent.



*Because the message is sent to many recipients, the addressees are hidden. If you want the addressee to be shown, place @ before the email address (e.g. @j.smith@example.com).*

**ON** – if this option is enabled, event notifications can be sent to the indicated e-mail address.

### 11.3.1 Events assignment

Select the types of events, the occurrence of which in selected partitions will result in sending e-mail notifications.

### 11.3.2 E-mail server

**Mail server (SMTP)** – address of outgoing mail server.

**Server port** – number of outgoing mail port.

**User name** – name of the mail account used for authentication by the SMTP server (mail account login).

**Password** – password used for authentication by the SMTP server.

**Encryption** – you can specify whether and how the outgoing mail is to be encrypted:

**none** – outgoing mail will not be encrypted.

**STARTTLS** – outgoing mail will be encrypted using the STARTTLS protocol.

**SSL/TLS** – outgoing mail will be encrypted using the SSL/TLS protocol.

**Do not report SMTP server connection trouble [No SMTP trbl.]** – if this option is enabled, the failure sending e-mail will not trigger any trouble signal.

**Subject** – subject of the e-mail message. It will be inserted in each e-mail to be sent.

**Sender address** – e-mail address which will be inserted in the outgoing e-mail message as the sender address. If this field is blank, the name of e-mail account will be treated as the sender address.

## 11.4 Starting the voice messaging

---

1. Enable the TELEPHONE MESSAGING option.
2. Using the telephone options (see: “Telephone options” p. 69):
  - define the mode of dialing the telephone numbers (TONE DIALING option and – in case of the pulse dialing – PULSE DIALING 1/1.5 (OFF 1/2) option),
  - determine whether the control panel, prior to dialing the number, should check the telephone line for dialing signal (NO DIAL TONE TEST option),
  - determine whether the control panel is to play back the voice message after going off-hook, or 15 seconds after the dialing is completed (global option NO ANSWER TEST).
  - determine whether the voice message is to be played back once or twice (option DOUBLE VOICE MESSAGE).
3. Define the number of attempts to get connected in one round (function MAX. REDIAL NUMBER FOR ONE ROUND).
4. Define parameters of the telephones to which messages are to be sent:
  - name (up to 16 characters),

- telephone number,
  - type of messaging (select 0 – voice),
  - number of attempts made by the control panel to notify the indicated telephone number about the event, if receipt of the message has not been acknowledged,
  - how the receipt of voice message is to be acknowledged (if the messaging is to be acknowledged, enable the ANY CODE option or enter the 4-digit code).
5. Record or synthesize the voice messages which are to be used for messaging (see: CA-64 SM synthesizer or INT-VG voice module manual).
  6. For events about which the control panel is to inform, indicate:
    - number of the voice message to be used for messaging,
    - telephones to be notified.
  7. In order to limit unnecessary messaging, define the cases in which notification can be cancelled (the parameters CLEARING IN PARTITIONS and CLEARING AFTER ACKNOWLEDGEMENT and the option CLEAR MESSAGING ON ALARM CLEARING).

## 12. Answering phone calls and remote control

The call answering function allows the control panel users to receive information on the partition status (arm mode, alarms). Owing to the telephone control function, the users can control the REMOTE SWITCH outputs by means of a telephone.

**i** | *The INT-VG module offers a much larger scope of the alarm system remote operation functionality using a telephone.*

The parameters of telephone answering and control can be programmed:

- using the keypad, in the service mode, by means of the functions available in the TEL.ANSW./CTRL. submenu,
- using the DLOADX program, in the “Answering and remote control” window.

### 12.1 Telephone answering and control parameters and options

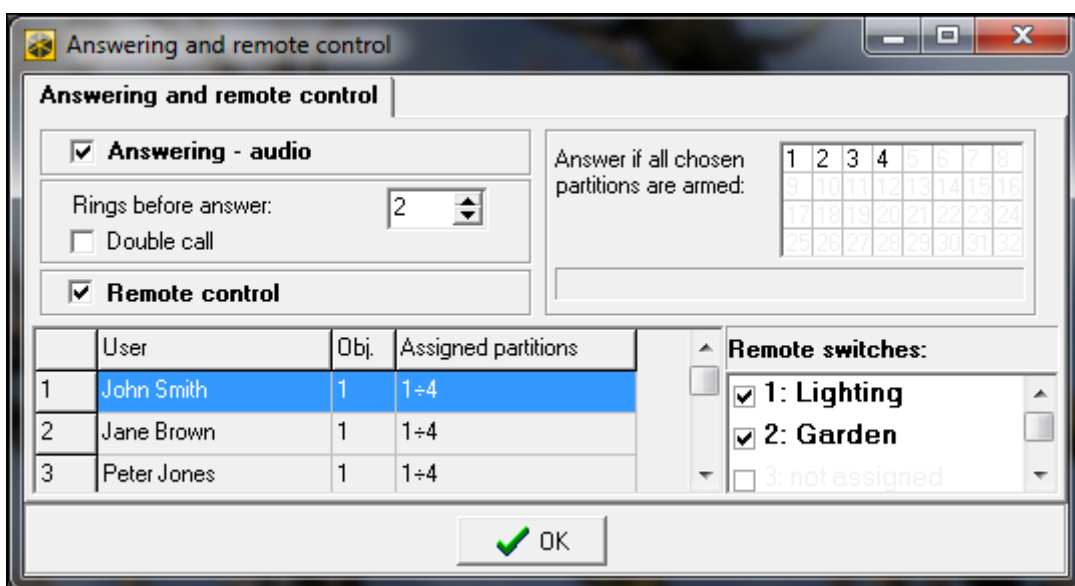

Fig. 13. “Answering and remote control” window in the DLOADX program.

See also section “Telephone options” p. 69.

Shown in square brackets are the names used in keypads.

**Answer if all chosen partitions are armed** [On armed part.] – you can indicate the partitions whose status will affect the telephone answering and control functions (they will only be executed, if all indicated partitions are armed).



*If the ANSWERING - MODEM option is enabled, the control panel will be answering the calls whether the partitions are armed or not.*

### 12.1.1 Users and remote switches

The telephone control function requires that REMOTE SWITCH type outputs, which can be controlled by users, be individually assigned to each user.

## 12.2 Activation of the phone calls answering

---

1. Enable the ANSWERING - AUDIO option.
2. Define the rules of call answering by the control panel (RINGS BEFORE ANSWER parameter and DOUBLE CALL option).
3. Define whether the function is to be available at all times, or only when selected partitions are armed (function ANSWER IF PARTITIONS ARE ARMED).
4. Program the telephone codes for the users who are to use the function (see: USER MANUAL).

## 12.3 Activation of the remote control



---

1. Activate the call answering function.
2. Enable the REMOTE CONTROL option.
3. Program the selected outputs as the REMOTE SWITCH.
4. Assign the REMOTE SWITCH type outputs to the users who are to use the function.

## 13. Control panel firmware update

---

Available on the [www.satel.pl](http://www.satel.pl) website is the current version of control panel firmware and the FLASHX program enabling to write it to the control panel. In order to update the firmware:

1. Connect the control panel RS-232 or USB port to the computer port (for the connection method please refer to the INSTALLER MANUAL).
2. Start the FLASHX program.
3. Click on the  button to select the file with control panel new firmware.
4. Click on the  button to indicate the port to be used for communication with the control panel and start the firmware update.
5. Using the function available in the service mode, start the STARTER program in the control panel (►RESTARTS ►STARTER).



**During operation of the STARTER program the control panel does not perform its normal functions (only the status of electronic fuses being monitored).**

**The STARTER program is waiting 2 minutes for the procedure of control panel firmware update to begin. If it does not happen, the control panel will return to the service mode.**

**If the firmware update is suddenly terminated (e.g. due to loss of power) and, as a result, the control panel firmware is damaged, the STARTER program will start automatically and will remain active until the correct firmware is installed.**

**You can run the STARTER program by shorting the RESET pins when starting the control panel – remove the short immediately after power-up (within approx. one second).**

## 14. Manual update history

Date	Firmware version	Introduced changes
2013-08	1.12	<ul style="list-style-type: none"> <li>• Information on INTEGRA 256 Plus control panel has been added.</li> <li>• Section “Hiding the service mode” has been added (p. 6).</li> <li>• List of functions available in the service mode menu has been supplemented (p. 6-25).</li> <li>• Note has been added to inform in which situations the local programming function must be disabled (p. 34).</li> <li>• Description of how to configure the GSM module for GPRS remote programming has been modified (p. 42).</li> <li>• Description of 3. INTERIOR DELAYED type zone has been modified (p. 52).</li> <li>• Description of 93. OUTPUTS GROUP ON type zone has been added (p. 54).</li> <li>• Description of DELAY IN 2&amp;3 TYPE ARMING option has been added (p. 55).</li> <li>• Description of 95. IP REPORTING TROUBLE type output has been modified (p. 63).</li> <li>• Description of 118. KEYFOB BATTERY LOW type output has been modified (p. 64).</li> <li>• Description of 119. WIRELESS MODULE JAMMING type output has been modified (p. 64).</li> <li>• Note on the forcing output has been added (p. 66).</li> <li>• Note on displaying the output status and zone 256 has been added (p. 59).</li> <li>• Description of REPORTING – ETHM-1 option has been modified (p. 69).</li> <li>• Description of RETURN TO MENU FROM MENU “TEST” has been modified (p. 71).</li> <li>• Description of GRADE 3 option has been modified (p. 73).</li> <li>• Description of TAMPER IF NO COMMUNICATION WITH ABAX DEVICE (2H) option has been added (p. 73).</li> <li>• Description of HIDE SERVICE MODE AFTER option has been modified (p. 75).</li> <li>• Description of DO NOT REPORT TIME SERVER TROUBLE option has been added (p. 75).</li> <li>• Note about INTEGRA 256 Plus control panel and CHIME signal in keypads has been added (p. 77).</li> <li>• Note about chime disabling zone has been added (p. 77).</li> <li>• Note about controlling authentication method and outputs 255 and 256 has been added (p. 82).</li> <li>• Note about INTEGRA 256 Plus control panel and auto-backlight has been added (p. 80).</li> <li>• Description of timer exceptions has been modified (p. 83).</li> <li>• Description of IP FORMAT parameter has been added (p. 87).</li> <li>• Description of PROTOCOL parameter has been added (p. 87).</li> <li>• Section describing additional parameters for SIA-IP reporting has been added (p. 88).</li> <li>• Section on reporting via Ethernet has been modified (p. 90).</li> <li>• Section on GPRS reporting stating has been modified (p. 90).</li> <li>• Information on ACU-250 and INT-RX-S modules has been added.</li> </ul>
2013-12	1.12	<ul style="list-style-type: none"> <li>• Information on the INT-KLFR , INT-TSG and INT-TSI keypads has been added.</li> <li>• Information on INT-RS Plus module has been added.</li> </ul>
2014-10	1.13	<ul style="list-style-type: none"> <li>• Information on ACU-120 and ACU-270 controllers has been added.</li> </ul>

		<ul style="list-style-type: none"> <li>• Information on ETHM-1 Plus module has been added.</li> <li>• List of functions available in the service mode menu has been supplemented (p. 6-25).</li> <li>• Information on new functionality of key 0 when editing the multiple selection list in text mode has been added (p. 25).</li> <li>• Description of ENTRY DELAY parameter has been modified (p. 49).</li> <li>• Description of ENTRY/EXIT INTERIOR zone type has been added (p. 54).</li> <li>• Description of WITH VERIFICATION option has been modified (p. 55).</li> <li>• Description of BLOCKS VERIFICATION option has been modified (p. 57).</li> <li>• Description of E-MAIL MESSAGING option has been added (p. 69).</li> <li>• Description of GRADE 3 option has been modified (p. 72).</li> <li>• Description of NO SHORTCUTS IN MENU option has been added (p. 73).</li> <li>• Description of EXTENDED CHARSET option has been added (p. 86).</li> <li>• Section describing test transmissions has been modified (p. 89).</li> <li>• Section describing parameters and options of e-mail notification has been added (p. 95).</li> </ul>
2015-10	1.14	<ul style="list-style-type: none"> <li>• Structure of the manual has been modified.</li> <li>• Information on INT-TSH keypad has been added.</li> <li>• List of functions available in the service mode menu has been supplemented (p. 6-25).</li> <li>• Information on the required version of DLOADX program has been added (p. 27).</li> <li>• Section has been added to describe parameters related to communication between the control panel and the DLOADX program (p. 29).</li> <li>• Section describing how to start remote programming via modem has been modified (p. 34).</li> <li>• Section describing how to start remote programming via Ethernet has been modified (p. 38).</li> <li>• Information on communication via the SATEL server has been added (p. 38 and p. 40).</li> <li>• Section describing how to start remote programming via GPRS has been modified (p. 40).</li> <li>• Section on files with data saved by the DLOADX program has been added (p. 43).</li> <li>• Description of ZONE SENSITIVITY parameter has been modified (p. 51).</li> <li>• Description of 95. ENTRY INTERIOR zone type has been added (p. 54).</li> <li>• Description of 96. FIRE MONITORING zone type has been added (p. 54).</li> <li>• Description of PULSATING option has been corrected (p. 64).</li> <li>• Description of HYSTERESIS parameter has been added (p. 66).</li> <li>• Section describing system options has been modified (p. 68).</li> <li>• Section describing parameters and options of keypads has been modified (p. 76).</li> <li>• Section describing timers has been modified (p. 83).</li> <li>• Description of HEX option has been added (p. 88).</li> <li>• Description of SIA-IP ACCT parameter has been added (p. 88).</li> <li>• Description of SENDER ADDRESS parameter has been added (p. 95).</li> </ul>
2016-04	1.15	<ul style="list-style-type: none"> <li>• Information on the required version of DLOADX program has been modified (p. 27).</li> <li>• Description of DO NOT REPORT SMTP SERVER TROUBLE option has been added (s. 95).</li> </ul>
2017-05	1.17	<ul style="list-style-type: none"> <li>• List of functions available in the service mode menu has been supplemented (p. 6-25).</li> <li>• Information on the required version of DLOADX program has been modified (p. 27).</li> </ul>

		<ul style="list-style-type: none"> <li>• Information on the output cut-off time has been modified (p. 59).</li> <li>• Information on the output state indication has been modified (p. 59).</li> <li>• Description of the GRADE 3 option has been modified (p. 72).</li> <li>• Description of DO NOT REPORT SATEL SERVER CONNECTION TROUBLE option has been added (p. 73).</li> <li>• Name of the DO NOT REPORT TIME SERVER TROUBLE option has been changed to DO NOT REPORT TIME SERVER CONNECTION TROUBLE (p. 75).</li> <li>• Name of the SHOW ENTRY DELAY OF PARTITIONS parameter has been changed to DISPLAY ENTRY DELAY OF PARTITIONS (p. 77).</li> <li>• Name of the SHOW EXIT DELAY OF PARTITIONS parameter has been changed to DISPLAY EXIT DELAY OF PARTITIONS (p. 77).</li> <li>• Description of SIGNAL ENTRY DELAY OF PARTITIONS parameter has been added (p. 77).</li> <li>• Description of SIGNAL EXIT DELAY OF PARTITIONS parameter has been added (p. 77).</li> <li>• Name of the DO NOT REPORT SMTP SERVER TROUBLE option has been changed to DO NOT REPORT SMTP SERVER CONNECTION TROUBLE (p. 95).</li> </ul>
2018-06	1.18	<ul style="list-style-type: none"> <li>• List of functions available in the service mode menu has been supplemented (p. 6-25).</li> <li>• Information on the required version of DLOADX program has been modified (p. 27).</li> <li>• Section “Ethernet communication parameters” has been modified and supplemented (p. 31).</li> <li>• Section “Cellular data network communication parameters” has been modified and supplemented (p. 32).</li> <li>• Section “Starting remote programming via Ethernet network” has been modified and supplemented (p. 38).</li> <li>• Section “Starting remote programming via the cellular data network” has been modified and supplemented (p. 40).</li> <li>• Description of 97. FIRE PANEL FAULT. MONIT. zone type has been added (p. 54)</li> <li>• Description of EVENT: ARMING FAILED option has been added (p. 56).</li> <li>• Description of REPORTING – GPRS option has been modified (p. 69).</li> <li>• Description of REPORTING – ETHM option has been modified (p. 69).</li> <li>• Description of REPORTING – ETHM/INT-GSM option has been added (p. 69).</li> <li>• Description of SMS MESSAGING option has been modified (s. 69).</li> <li>• Note regarding SMS MESSAGING option has been added (p. 69).</li> <li>• Description of E-MAIL MESSAGING option has been modified (p. 69).</li> <li>• Description of MODEM ISDN/GSM/ETHM option has been modified (p. 69).</li> <li>• Description of ANSWERING - ETHM/GSM option has been modified (p. 69).</li> <li>• Description of DO NOT REPORT LAN LOSS ON AC LOSS option has been added (p. 73).</li> <li>• Description of NO ARMED INDICATION AFTER option has been modified (p. 74).</li> <li>• Description of TIME SERVER option has been modified (p. 75).</li> <li>• Description of CARD READER FILTER parameter has been modified (p. 80).</li> <li>• Section “Reporting” has been modified and supplemented (p. 84).</li> <li>• Section “Messaging” has been modified and supplemented (p. 92).</li> </ul>
2019-05	1.19	<ul style="list-style-type: none"> <li>• Information about ABAX 2 system devices has been added.</li> <li>• List of functions available in the service mode menu has been supplemented (p. 6-25).</li> <li>• Information on the required version of DLOADX program has been modified (p. 27).</li> <li>• Description of REPORTING DELAY option has been modified (p. 56).</li> <li>• Description of 83. OUTPUTS OFF type output has been modified (p. 62).</li> <li>• Description of 120. THERMOSTAT type output has been modified (p. 64).</li> </ul>

		<ul style="list-style-type: none"> <li>• Description of ON/OFF option has been added (p. 65).</li> <li>• Description of TEMPERATURE DETECTOR parameter has been modified (p. 66).</li> <li>• Description of HYSTERESIS parameter has been modified (p. 66).</li> <li>• Description of SILENT PANIC ALARM option has been modified (p. 79).</li> <li>• Description of functions started by long press of a numeric key on the keypad has been modified (p. 80).</li> <li>• Description of starting SMS reporting via the INT-GSM module has been modified (p. 92).</li> <li>• A note on presenting e-mail addresses for e-mail messaging has been added (p. 95).</li> </ul>
2021-08	1.20	<ul style="list-style-type: none"> <li>• Information on the INT-GSM LTE module has been added.</li> <li>• Information on the INT-TSG2 and INT-TSH2 keypads has been added.</li> <li>• List of functions available in the service mode menu has been supplemented (p. 6-25).</li> <li>• Information on the required version of DLOADX program has been modified (p. 27).</li> <li>• Description of AC LOSS FAST option has been added (p. 65).</li> <li>• Section describing the keypad settings has been modified (p. 76).</li> <li>• Description of EVENT-INDEPENDENT POOLING option has been added (p. 88).</li> </ul>
2022-11	1.21	<ul style="list-style-type: none"> <li>• List of functions available in the service mode menu has been modified (p. 6-25).</li> <li>• Information on the required version of DLOADX program has been modified (p. 27).</li> <li>• Description of GROUP parameter has been modified (p. 50).</li> <li>• Description of 82. ARM/DISARM type zone has been modified (p. 54).</li> <li>• Section "Groups of partitions" has been modified (p. 58).</li> <li>• Description of 31. BATTERY TROUBLE (MAINBOARD) type output has been modified (p. 61).</li> <li>• Section "120. Thermostat output settings" has been modified (p. 66).</li> </ul>