

Keypad  
**INT-TSG2**

Firmware version 2.01

**EN**

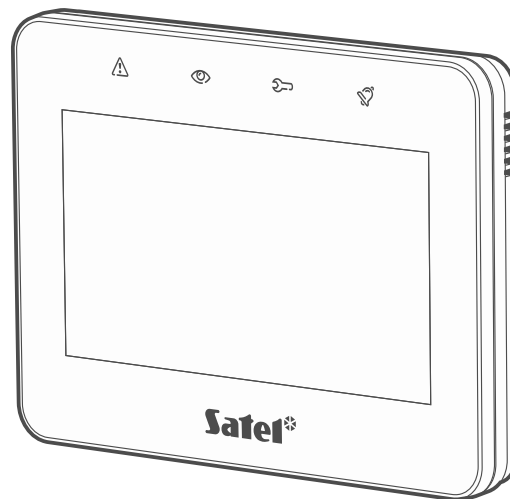

**CE**



**INSTALLER MANUAL**

int-tsg2\_i\_en 03/23

**Satel**®

SATEL sp. z o.o. • ul. Budowlanych 66 • 80-298 Gdańsk • POLAND  
tel. +48 58 320 94 00  
[www.satel.pl](http://www.satel.pl)

## IMPORTANT

The keypad should be installed by qualified personnel.

Read carefully this manual before proceeding to installation.

Changes, modifications or repairs not authorized by the manufacturer shall void your rights under the warranty.

### Warning

This is a Class A product. In a domestic environment this product may cause radio frequency interference.

SATEL aims to continually improve the quality of its products, which may result in changes in their technical specifications and software. Current information about the changes being introduced is available on our website.

Please visit us at:  
<https://support.satel.pl>

The declaration of conformity may be consulted at [www.satel.pl/ce](http://www.satel.pl/ce)

The following symbols may be used in this manual:



- note,



- caution.

## CONTENTS

1. Features .....	3
2. Using the touch screen.....	3
Tap.....	3
Tap and hold.....	4
Swipe up / down.....	4
Swipe right / left.....	4
Swipe right from the edge (return to the previous screen) .....	5
3. Installation.....	5
3.1 Description of terminals .....	7
3.2 Address setting.....	7
3.2.1 Address setting in the factory new keypad.....	7
3.2.2 Address setting in the service mode .....	7
Keypad in the INTEGRA system.....	7
Keypad in the PERFECTA 64 M system.....	9
Keypad in the VERSA system.....	12
3.2.3 Address setting without starting the service mode .....	14
3.3 Identification .....	14
3.3.1 Keypad identification in the INTEGRA system .....	14
Keypad.....	14
DLOADX program.....	14
3.3.2 Keypad identification in the PERFECTA 64 M system .....	14
Keypad.....	14
PERFECTA SOFT program.....	15
3.3.3 Keypad identification in the VERSA system .....	15
Keypad.....	15
DLOADX program.....	15
4. Memory card .....	15
4.1 Inserting the card.....	15
4.2 Removing the card.....	16
4.3 Slideshow .....	16
4.4 Site plan / background image .....	16
4.5 New firmware.....	16
5. Preparing the image files.....	16
6. Programming.....	17
6.1 Keypad in the INTEGRA system.....	17
6.1.1 Programming with the DLOADX program .....	17
6.1.2 Programming from the keypad.....	17
6.1.3 Keypad settings.....	17
Keypad.....	17
Keypad data.....	20
6.2 Keypad in the PERFECTA 64 M system .....	34
6.2.1 Programming with the PERFECTA SOFT program .....	34
6.2.2 Programming from the keypad.....	35
6.2.3 Keypad settings.....	35
Keypad.....	35
Screen.....	37
6.3 Keypad in the VERSA system .....	50
6.3.1 Programming with the DLOADX program .....	50

---

- 6.3.2 Programming from the keypad .....50
- 6.3.3 Keypad settings .....51
  - INT-TSG2.....51
  - Keypad data .....53
  - Macro Commands .....53
  - Screen .....56
- 7. Updating the keypad firmware .....56
  - 7.1 Update using the function .....56
    - 7.1.1 Keypad in the INTEGRA system .....56
    - 7.1.2 Keypad in the PERFECTA 64 M system .....57
    - 7.1.3 Keypad in the VERSA system .....57
  - 7.2 Update after restart .....58
- 8. Specifications .....58
- 9. Manual update history .....58

The INT-TSG2 keypad allows you to operate and program:

- INTEGRA series control panels (firmware version 1.21 or newer),
- PERFECTA 64 M control panel,
- VERSA series control panels (firmware version 1.06 or newer).

## 1. Features

---

- Touch screen:
  - diagonal: 4.3",
  - resolution: 480 x 272,
  - color depth: 24 bpp.
- Customizable user screens.
- Widget-based operation of the alarm system.
- Alarm system control by means of macro commands to facilitate the running of functions.
- Possibility to display plans of the protected site.
- Intuitive icon-based user menu.
- Customizable screensaver.
- Possibility to display a slideshow.
- LEDs indicating the state of system.
- Built-in reader of microSD memory cards.
- Built-in sounder for signaling.
- 2 programmable hardwired zones (supported by the INTEGRA series control panels):
  - support for NO and NC type detectors, as well as roller shutter and shock detectors,
  - support for EOL, 2EOL and 3EOL configuration (3EOL for the INTEGRA Plus control panels),
  - programmable end-of-line resistor value.
- Tamper protection against enclosure opening and removal from mounting surface.

## 2. Using the touch screen

---

Use the gestures described below.

### Tap

Tap on an item on the screen.

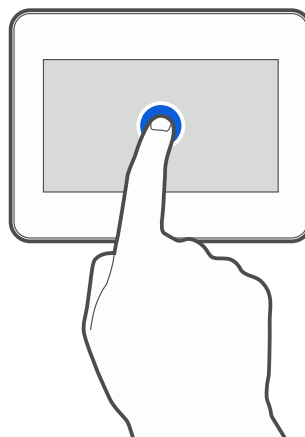

## Tap and hold

Tap on an item on the screen and hold for 3 seconds.

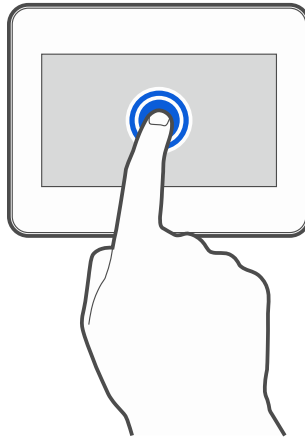

## Swipe up / down

Tap the screen and slide your finger up or down to:

- swipe the screen up / down (move between the screensaver / user screen / user menu home screen),
- scroll through a list.

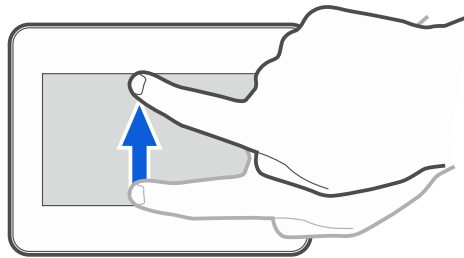

## Swipe right / left

Tap the screen and slide your finger right or left to swipe the screen right / left (go to the previous / next screen). When the screensaver is active, swipe right / left to start / end the slideshow.



*The slideshow is available when a memory card containing image files is installed in the keypad.*

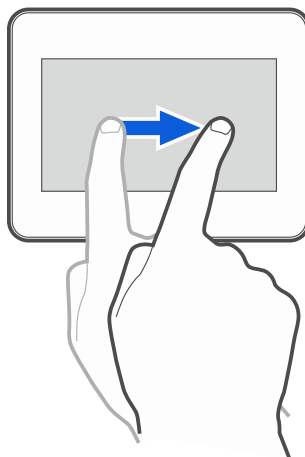

### Swipe right from the edge (return to the previous screen)

Tap the screen close to the left edge and slide your finger right to return to the previous screen. This gesture is supported in the user menu and the service menu. You will not be able to exit the service mode by using this gesture.

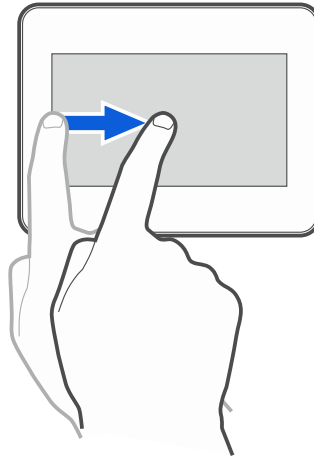

## 3. Installation



**Disconnect power before making any electrical connections.**

The INT-TSG2 keypad is designed for indoor installation. The place of installation should be readily accessible to the system users.

1. Open the keypad enclosure (Fig. 1). The enclosure opening tool, shown in the illustration, is included in the keypad delivery set.

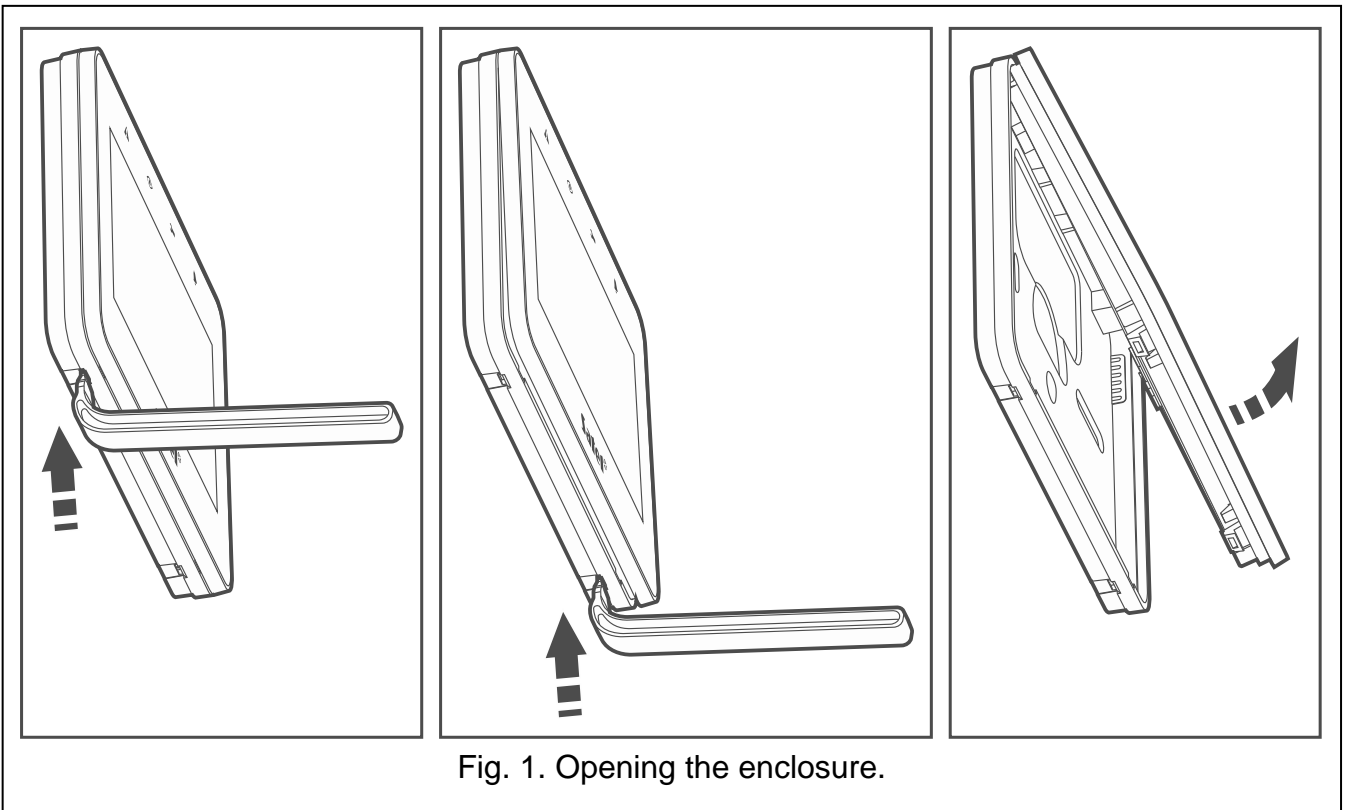

2. Place the enclosure base on the wall and mark the location of mounting holes.
3. Drill the holes for wall plugs (screw anchors).
4. Run the wires through the opening in the enclosure base.

5. Use wall plugs (screw anchors) and screws to fasten the enclosure base to the wall. Select wall plugs specifically intended for the mounting surface (different for concrete or brick wall, different for drywall, etc.).
6. Connect the DTM, CKM and COM keypad terminals to the appropriate terminals of the control panel communication bus (Fig. 2). To make the connection, use an unshielded non-twisted cable. If you use the twisted-pair type of cable, remember that CKM (clock) and DTM (data) must not be sent through one twisted-pair cable. The wires must be run in one cable. The length of cables must not exceed 300 m.

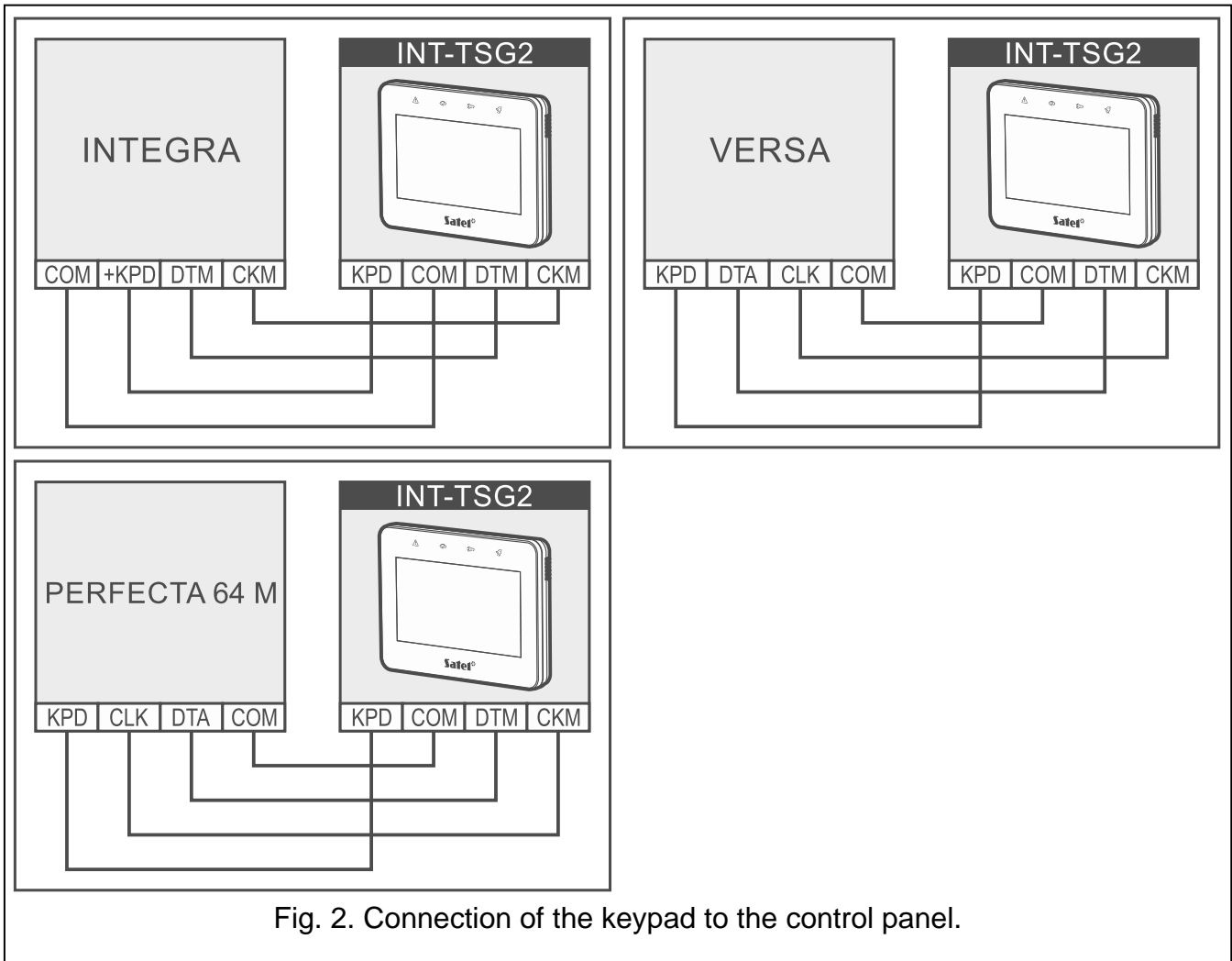

Fig. 2. Connection of the keypad to the control panel.

7. If you wish to connect any detectors to the Z1 and Z2 zones, connect the wires to the terminals (connect the detectors in the same way as to the control panel onboard zones – **use the keypad COM terminal**).
8. Connect the supply wires to the KPD and COM terminals. The keypad can be powered directly from the control panel, from an expander with power supply or from an additional power supply. The table shows the requirements regarding the power wires (KPD and COM), if conductors with 0.5 mm diameter are used.

Distance from control panel	Number of parallel connected wires
up to 25 m	1
25 – 50 m	2
50 – 75 m	3
75 – 100 m	4

9. Place the front panel onto the catches and snap close the enclosure.

### 3.1 Description of terminals

---

- KPD** - power supply input.
- COM** - common ground.
- DTM** - data.
- CKM** - clock.
- Z1, Z2** - zones.
- RSA, RSB** - terminals provided for future applications (RS-485).

### 3.2 Address setting

---

Each keypad connected to the control panel must have its individual address set in it. By default, address 0 is set in the keypad.

The keypad must have an address set in it:

- for the INTEGRA 24 / INTEGRA 32 / PERFECTA 64 M control panel: in the range from 0 to 3,
- for other INTEGRA or INTEGRA Plus control panel: in the range from 0 to 7,
- for the VERSA series control panel: in the range from 0 to 5.



*When started with factory default settings, the control panel will support all keypads connected to the bus, irrespective of the addresses set in them. Otherwise, keypads with identical addresses are not supported.*

If the keypad is connected to the INTEGRA series control panel, the address set in the keypad determines the numbers to be given to the keypad zones (see the installer manual for the INTEGRA or INTEGRA Plus control panels).

You can set the address:

- after you connect the factory new keypad to the control panel and start the keypad. You will be able to use the keypad after you set the address.
- after you started the service mode. The address setting function is available in the service menu. You can start it from any keypad supported by the control panel. After starting it, you can set the address in all wired keypads.
- without starting the service mode. When operation of the keypads is blocked and it is impossible to start the service mode (e.g. the address of the new keypad and the address of the keypad installed previously are the same), it is the only way to set the address.

#### 3.2.1 Address setting in the factory new keypad



*The keypad must be connected to the control panel communication bus.*

1. Power on the keypad. The following message will be displayed: "This LCD address (n, 0-x)" [n – keypad address; 0-x – range of supported addresses].
2. Enter the keypad address and tap . The keypad will restart.

#### 3.2.2 Address setting in the service mode

##### Keypad in the INTEGRA system

##### ***Starting the service mode in the INTEGRA system***

1. Tap the keypad screen. The user screen will be displayed.
2. Swipe the screen up. The on-screen keypad will be displayed (Fig. 3).

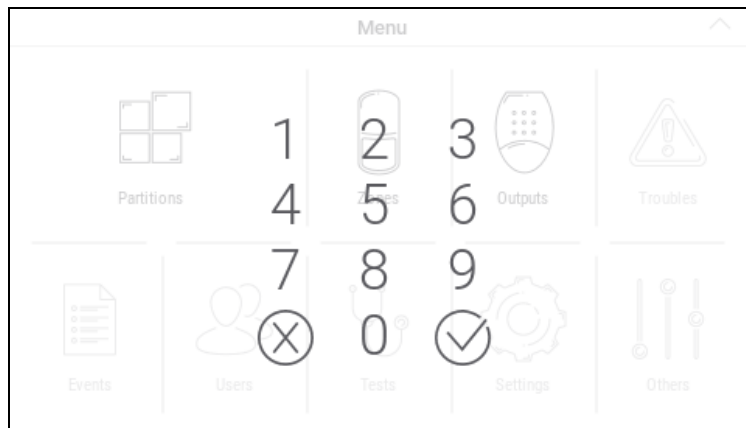



Fig. 3. On-screen keypad.

3. Enter the service code (by default: 12345) and tap . The user menu home screen will be displayed (Fig. 4).

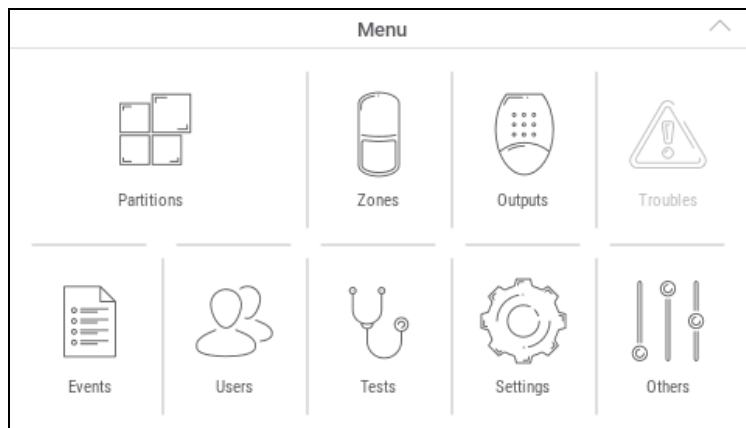

Fig. 4. User menu home screen.

4. Tap the "Others" function. A list of functions will be displayed (Fig. 5).

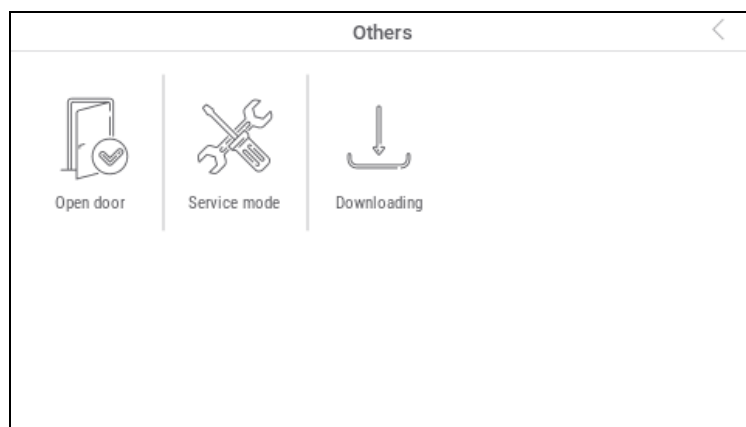

Fig. 5. Functions available on the "Others" screen (example).

5. Tap the "Service mode" function. The service menu will be displayed (Fig. 6).

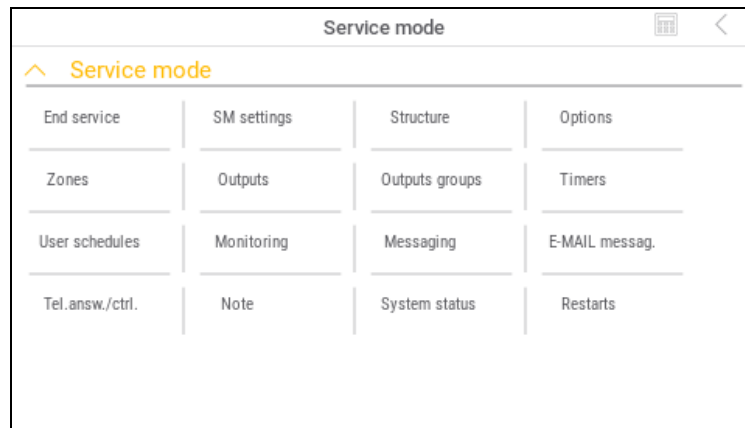

Fig. 6. Service menu.



The procedure described above applies to the keypad with factory default settings. You can configure the keypad so that the access to the user screen is code-protected (a keypad will appear before the user screen is displayed).

### Address setting in the INTEGRA system

1. Tap "Structure" ► "Hardware" ► "Identification" ► "Keypads addr.". All wired keypads will display the message: "This LCD address (n, 0-x)" [n – keypad address; 0-x – range of supported addresses] (Fig. 7).



Fig. 7. Address setting.

2. Use on-screen keypad to enter the new keypad address and tap . The keypad will restart. The service menu will be displayed.



If you fail to set the new address within 2 minutes after you started the "Keypads addr." function, the function will be terminated automatically and the keypad will restart.

### Keypad in the PERFECTA 64 M system

#### Starting the service mode in the PERFECTA 64 M system

1. Tap the keypad screen. The user screen will be displayed.
2. Swipe the screen up. The on-screen keypad will be displayed (Fig. 8).

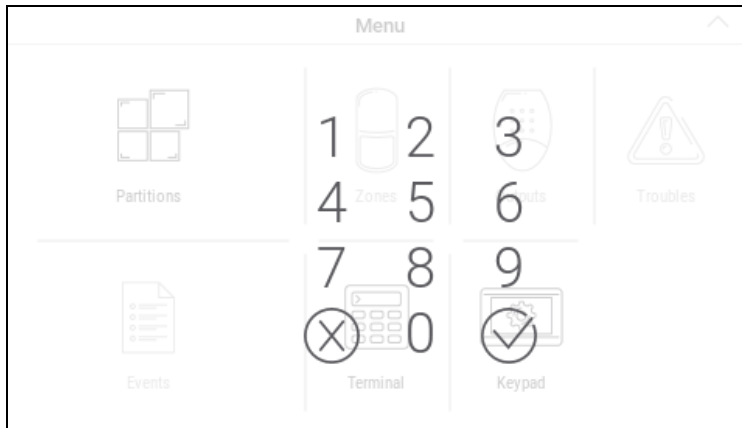



Fig. 8. On-screen keypad.

- 3. Enter the service code (by default: 12345) and tap . The user menu home screen will be displayed (Fig. 9).

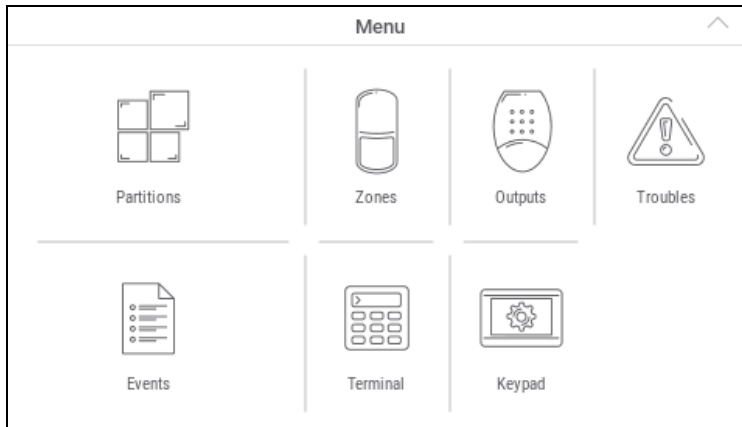





Fig. 9. User menu home screen.

- 4. Tap the "Terminal" function. The terminal will be displayed (Fig. 10).



Fig. 10. Terminal.

- 5. Enter the service code (by default: 12345) and tap . The user menu will be displayed.

6. Tap . The cursor will point to the “Service mode” function.
7. Tap . The service menu will be displayed (Fig. 11).

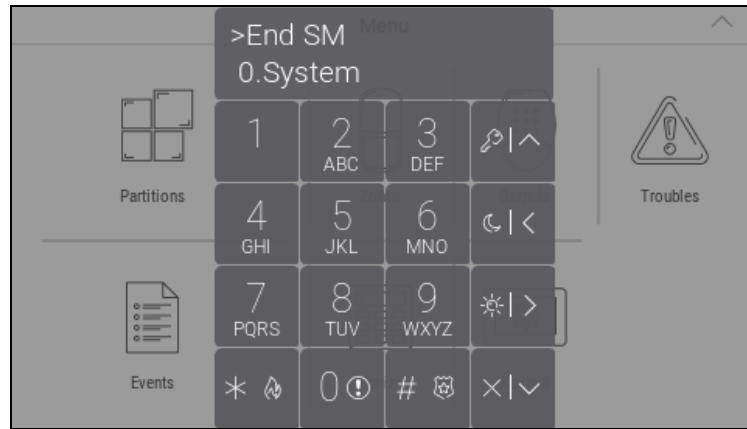





Fig. 11. Terminal displaying the service menu.

**i** | *The procedure described above applies to the keypad with factory default settings. You can configure the keypad so that the access to the user screen is code-protected (a keypad will open before the user screen is displayed).*

**Address setting in the PERFECTA 64 M system**

1. Tap   . The “20.Kpd.address.” function will start. All wired keypads will display the message: “This LCD address (n, 0-3) [n - keypad address; 0-3 – range of supported addresses] (Fig. 12).

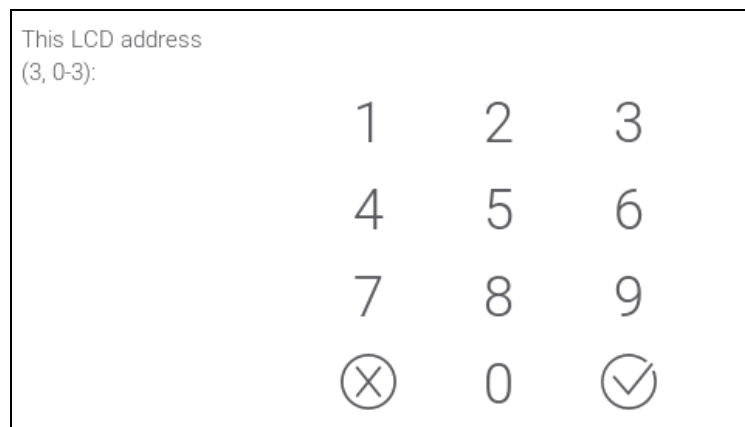

Fig. 12. Address setting.

2. Use on-screen keypad to enter the new keypad address and tap . The keypad will restart.

**i** | *If you fail to set the new address within 2 minutes after you started the “20.Kpd.address.” function, the function will be terminated automatically and the keypad will restart.*

### Keypad in the VERSA system

#### Starting the service mode in the VERSA system

1. Tap the keypad screen. The user screen will be displayed.
2. Swipe the screen up. The on-screen keypad will be displayed (Fig. 13).

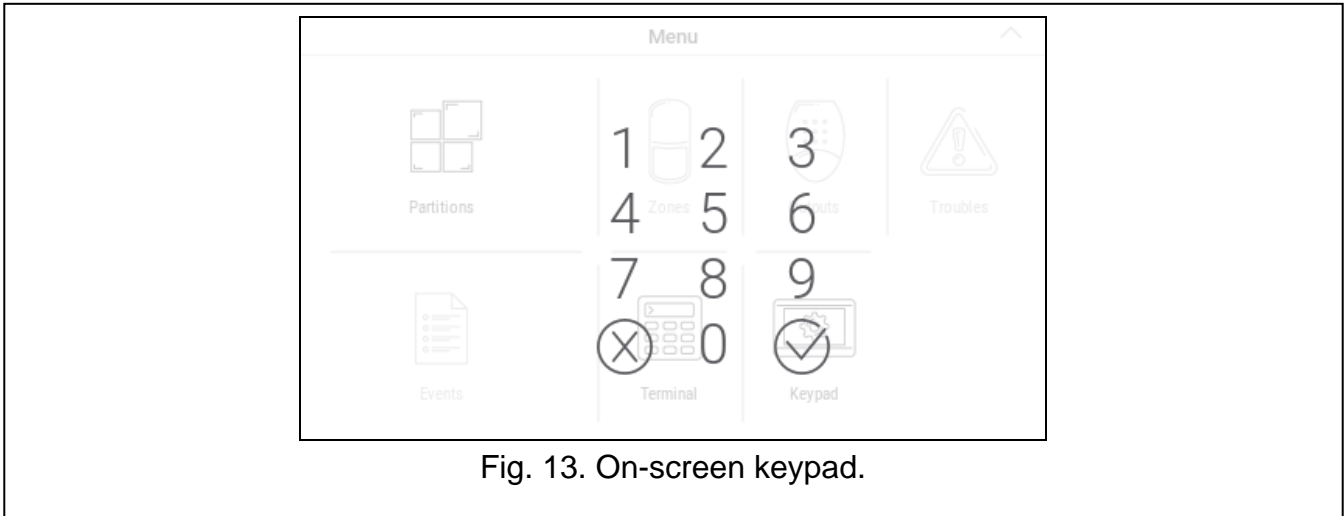



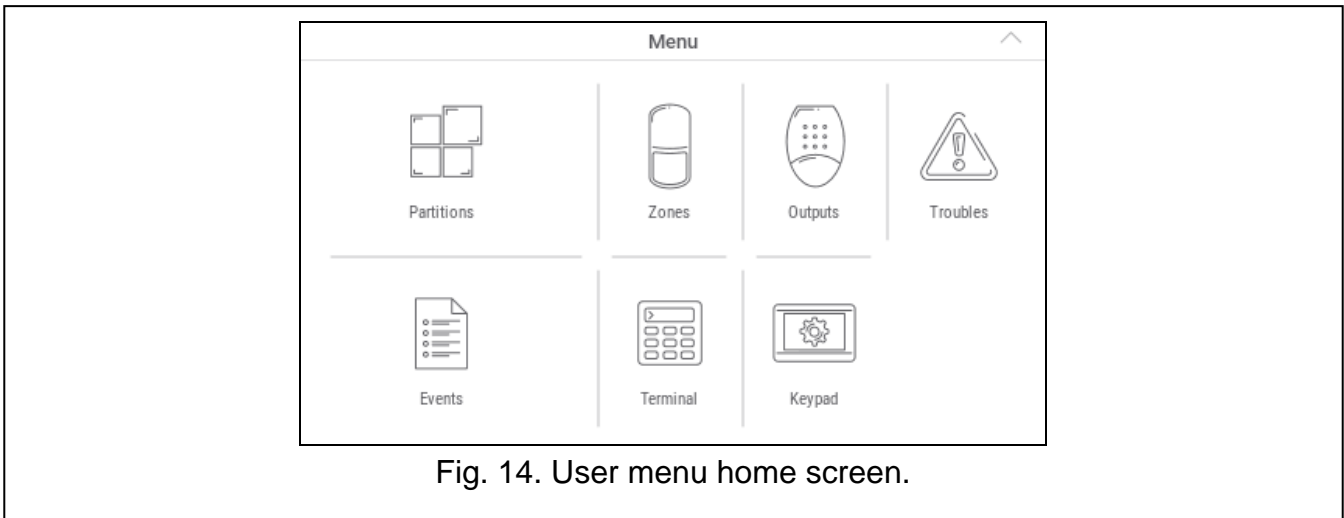

3. Enter the service code (by default: 12345) and tap . The user menu home screen will be displayed (Fig. 14).

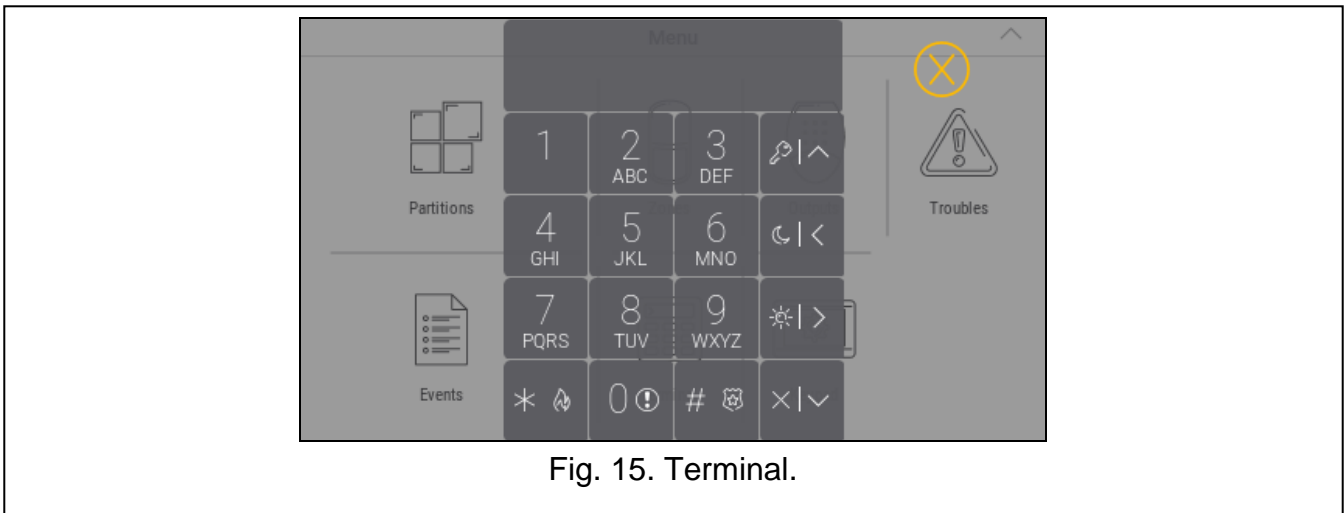

4. Tap the "Terminal" function. The terminal will be displayed (Fig. 15).



5. Enter the service code (by default: 12345) and tap . The user menu will be displayed.
6. Tap    . The service menu will be displayed (Fig. 16).

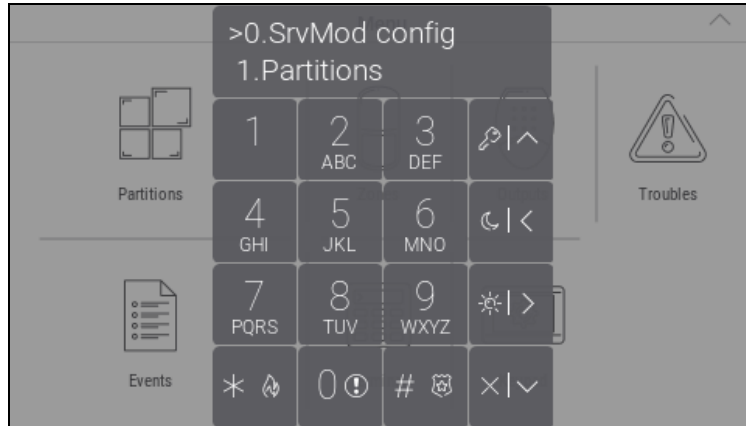







Fig. 16. Terminal displaying the service menu.

 *The procedure described above applies to the keypad with factory default settings. You can configure the keypad so that the access to the user screen is code-protected (a keypad will open before the user screen is displayed).*

**Address setting in the VERSA system**

1. Tap    . The “0.Keypads addr.” function will start. All wired keypads will display the message: “This LCD address (n, 0-5)” [n – keypad address; 0-5 – range of supported addresses] (Fig. 17).

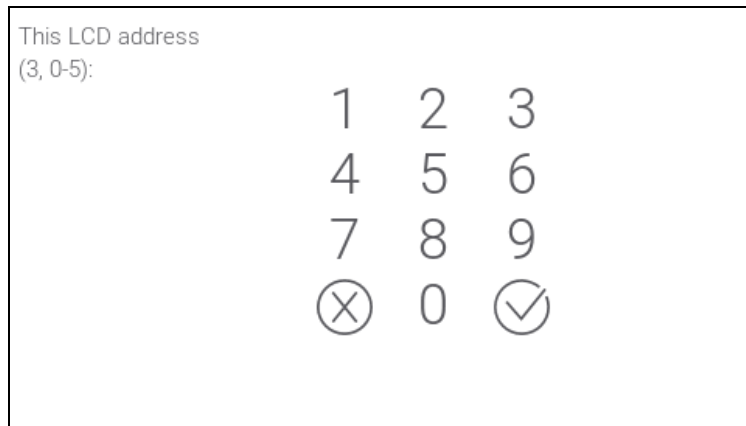





Fig. 17. Address setting.

2. Use on-screen keypad to enter the new keypad address and tap . The keypad will restart.

 *If you fail to set the new address within 2 minutes after you started the “Keypads addr.” function, the function will be terminated automatically and the keypad will restart.*

### 3.2.3 Address setting without starting the service mode

1. Power off the keypad.
2. Disconnect wires from the keypad terminals CKM and DTM.
3. Short the keypad terminals CKM and DTM.
4. Power on the keypad. Information about the set address and the on-screen keypad will be displayed.
5. Use on-screen keypad to enter the new address and tap . The keypad will restart. Information about the set address and the on-screen keypad will be displayed.
6. Power off the keypad.
7. Open the keypad terminals CKM and DTM.
8. Connect wires to the keypad terminals CKM and DTM.
9. Power on the keypad.

## 3.3 Identification

---

The devices connected to the control panel communication bus are supported correctly only if they are identified. Device identification is required at the first start-up of the control panel, and each time when a new device is added or address is changed in a device supported by the control panel. To run the identification function you can use the keypad or the DLOADX (INTEGRA / VERSA) / PERFECTA SOFT (PERFECTA 64 M) program.

 *Disconnecting an identified device from the communication bus will trigger the tamper alarm.*

### 3.3.1 Keypad identification in the INTEGRA system

#### Keypad



1. Start the service mode (see “Starting the service mode in the INTEGRA system” p. 7).
2. Tap “Structure” ► “Hardware” ► “Identification” ► “LCD keypads id.”. The identification function will start. The terminal will be displayed.
3. When identification is completed, information about the devices connected to the keypad bus will be displayed. Tap  to return to menu.

#### DLOADX program

1. Click  in the main menu. The “Structure” window will be displayed.
2. Click the “Hardware” tab.
3. Click the “Keypad” branch.
4. Click “Keypads identification”. The identification function will start.
5. When a window will be displayed with information that the identification is complete, click “OK”.

### 3.3.2 Keypad identification in the PERFECTA 64 M system

#### Keypad

1. Start the service mode (see “Starting the service mode in the PERFECTA 64 M system” p. 9).
2. Tap   . The identification function will start.



- When identification is complete, the total number of devices connected to the communication bus and the communication connector will be displayed. Tap  to return to the menu.

## PERFECTA SOFT program

- Click the “Hardware” tab.
- Click “Mainboard”.
- Click “Detect connected modules”.
- When identification is complete, a window with the total number of devices connected to the communication bus and the communication connector will be displayed.

### 3.3.3 Keypad identification in the VERSA system

#### Keypad

- Start the service mode (see “Starting the service mode in the VERSA system” p. 12).
- Tap . The identification function will start.
- When identification is completed, information about the devices found will be displayed.  
Tap  to return to the menu.

#### DLOADX program

- Click  in the main menu. The “VERSA – Structure” window will be displayed.
- Click the “Hardware” tab.
- Click the “Expansion modules” branch.
- Click “Identification”. The identification function will start.
- When identification is completed, a window will be displayed in which you will be asked if you want to read the data. Click “OK”.

## 4. Memory card

The keypad supports the microSD and microSDHC memory cards. You can save to the memory card:

- image files to be displayed in the slideshow,
- image files to be displayed on the user screens (protected site plan or background image),
- file with a new version of the keypad firmware when the firmware is to be updated.



*The memory card should be purchased separately.*

*To access the memory card slot, open the keypad enclosure. If the alarm system is working, start the service mode before you open the enclosure.*

The memory card slot is marked with the  symbol.

### 4.1 Inserting the card

When you insert the card into the slot, make sure to direct the card contacts toward the display.

Keep pushing the card into the slot until it clicks into place.

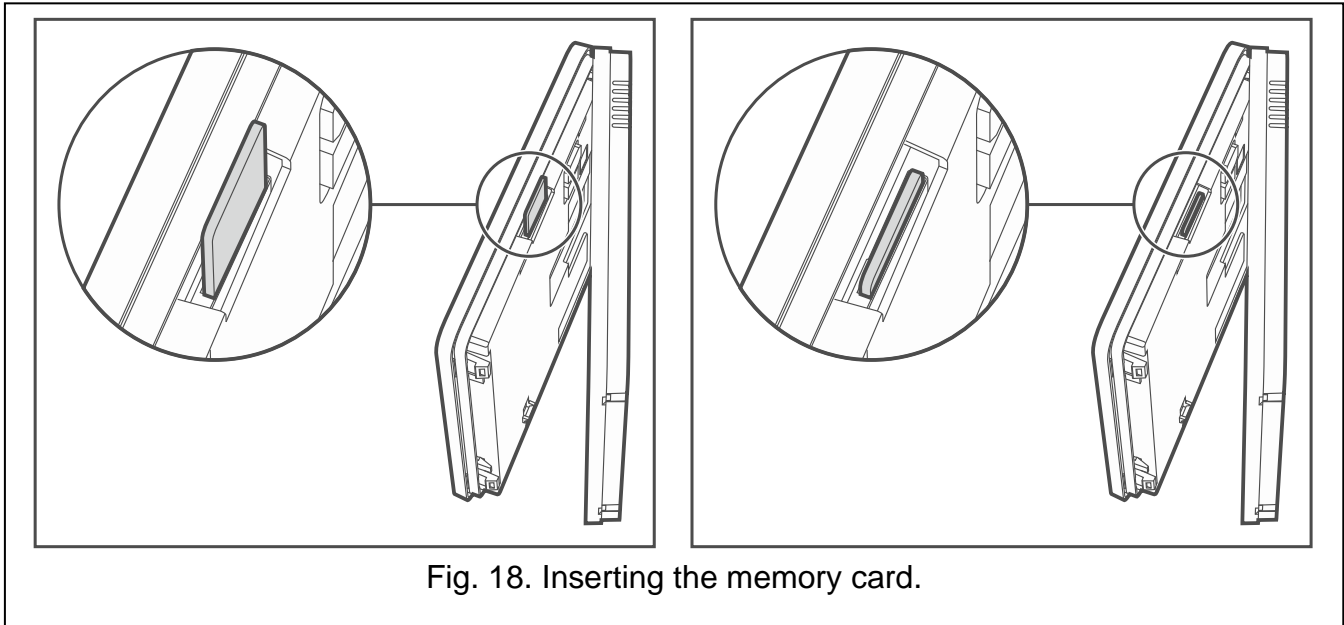

Fig. 18. Inserting the memory card.

## 4.2 Removing the card

---

Press the card to release it and remove it from the slot.

## 4.3 Slideshow

---

The keypad can run a slideshow of images if you saved the image files to the memory card. You can do it in the DLOADX (INTEGRA / VERSA) or PERFECTA SOFT (PERFECTA 64 M) program.

## 4.4 Site plan / background image

---

It is possible to display images on the user screens. The images can show a plan of the protected site or serve as a background image. If you want to use images other than the ones offered by SATEL, you must select them while programming the keypad settings in the DLOADX (INTEGRA / VERSA) or PERFECTA SOFT (PERFECTA 64 M) program and save them to the memory card.

## 4.5 New firmware

---

If a new version of the keypad firmware is published at [www.satel.pl](http://www.satel.pl), you can download it and save it to the card in order to later update the keypad firmware (see “Updating the keypad firmware” p. 56).

## 5. Preparing the image files

---

The slideshow images or user screen background images other than the ones provided by SATEL must be in the JPG format. You can prepare the image files using the PICUSTO app available at [www.satel.pl](http://www.satel.pl). The app is used to crop, resize and rotate images.

Once the files are ready, you can save them to the memory card while programming the keypad settings in the DLOADX (INTEGRA / VERSA) or PERFECTA SOFT (PERFECTA 64 M) program.

You can save the slideshow images directly in the memory card „photo” folder. If there is no such folder, create it first. The folder is created automatically, if you upload the files using the DLOADX (INTEGRA / VERSA) or PERFECTA SOFT (PERFECTA 64 M) program.

## 6. Programming

---

This section applies to the settings available only to the installer / service technician. The settings available to the keypad user are described in the user manuals.



### 6.1 Keypad in the INTEGRA system

---

You can configure all the keypad settings from the computer with the DLOADX program installed. Using the keypad, you can configure only some of the settings. Names of parameters and options from the DLOADX program are used in this manual.

#### 6.1.1 Programming with the DLOADX program

Required version of the DLOADX program: 1.21.001 (or newer).

1. Click  in the main menu. The “Structure” window will be displayed.
2. Click the “Hardware” tab.
3. Click the “Keypad” branch.
4. Click the name of the keypad whose settings you want to configure.
5. Configure the keypad settings.
6. Click  in the main menu to save changes to the control panel. For settings stored in the keypad (“Keypad data” tab), click the “Write” button.

#### 6.1.2 Programming from the keypad

1. Start the service mode (see “Starting the service mode in the INTEGRA system” p. 7).
2. Start the “Settings” function (► Structure ► Hardware ► LCD keypads ► Settings).
3. Tap the name of the keypad whose settings you want to configure.
4. Configure the keypad settings using the available functions (when you tap the function the terminal will be displayed).

#### 6.1.3 Keypad settings

Shown in square brackets are the names of parameters and options displayed in the keypad.

##### Keypad

**Name** – individual name of the keypad (up to 16 characters).

**Partitions managed by keypad** [Partitions] – partitions which can be armed / disarmed or in which an alarm may be cleared by using the keypad. These functions are available to the users who have a suitable authority level and access to those partitions.



*The service code gives access to all partitions irrespective of which partitions are operated by the keypad.*

**Show alarms of partitions** [Alarms] – the keypad can signal burglary alarms from selected partitions.

**Show fire alarms of partitions** [Fire alarms] – the keypad can signal fire alarms from selected partitions.

**CHIME signal of zones** [Chime zones] – the keypad can audibly signal violation of selected zones.

**Zone disabling chime** [Chime bps. zone] – violation of this zone will disable the CHIME feature.

**i** | *The zone 256 cannot disable the CHIME feature.*

The screenshot displays the 'Keypad' configuration window for 'Keypad INT-TSG Address:03'. The left sidebar shows a tree view of the system components, with 'Keypads' expanded to show '3: INT-TSG (3)' selected. The main panel is divided into several sections:

- Keypad data:** Name: INT-TSG (3)
- Partitions managed by keypad:** A grid of 32 buttons, with buttons 1-8 highlighted in orange.
- Show alarms of partitions:** A grid of 32 buttons, with buttons 1-8 highlighted in orange.
- Show fire alarms of partitions:** A grid of 32 buttons, with buttons 1-8 highlighted in orange.
- CHIME signal of zones:** A grid of 32 buttons, with buttons 1-8 highlighted in orange.
- Zone disabling chime:** Set to 0. Lock time: 0.
- Quick Arm partitions:** A grid of 32 buttons, with buttons 1-8 highlighted in orange.
- Display entry delay of partitions:** A grid of 32 buttons, with buttons 1-8 highlighted in orange.
- Display exit delay of partitions:** A grid of 32 buttons, with buttons 1-8 highlighted in orange.
- Signal entry delay of partitions:** A grid of 32 buttons, with buttons 1-8 highlighted in orange.
- Signal exit delay of partitions:** A grid of 32 buttons, with buttons 1-8 highlighted in orange.
- Additional options:**
  - Silent PANIC alarm
  - Entry delay signaling
  - Exit delay signaling
  - Sign. alarms
  - keypress beep
  - Sign. tbl in part. arm
  - Sign. new trouble
  - Show code entering
  - Show keypad name
  - Exit delay clearing enable
  - Show viol. zones
  - Auto-Arm delay countdown
  - Displ. mode switching
  - Show disarm messages
  - Show arm messages
  - Communication RS
  - Quick control
- Zone 119: "Zone 119"**:  in LCD keypad,  Not used
- Zone 120: "Zone 120"**:  in LCD keypad,  Not used
- Auto-backlight:**  Entry delay in part.: 1,  viol. of zone: 64,  no
- Wake-up:** Screensaver
- Tamper signaled in part.:** 1: Recepcja
- Comments:** (empty text field)

Fig. 19. DLOADX program: keypad in the INTEGRA system – “Keypad” tab (example settings).

**Bypass time** [Chime bps. time] – time during which the CHIME signal will be disabled after the zone which disables the signaling is violated (time is counted from the zone restore). If you enter 0, the signaling will not be disabled.

**Display entry delay of partitions** [Show entry del.] – the keypad displays information about entry delay countdown in selected partitions.

**Display exit delay of partitions** [Show exit delay] – the keypad displays information about exit delay countdown in selected partitions.

**Signal entry delay of partitions** [Sign.entry del.] – the keypad audibly signals the entry delay countdown in selected partitions.

**Signal exit delay of partitions** [Sign.exit delay] – the keypad audibly signals the exit delay countdown in selected partitions.

### ***Alarm messages***

**Partitions** [Part.al.msg.] – if this option is enabled, messages on partition alarms are displayed (they contain the name of partition).

**Zones** [Zone al.msg.] – if this option is enabled, messages on alarms from zones are displayed (they contain the name of zone). The zone alarm messages have the priority.

### ***Alarms***

**FIRE** [Fire alarm] – if this option is enabled, the user can trigger a fire alarm from the keypad by using a widget.

**PANIC** [Panic alarm] – if this option is enabled, the user can trigger a panic alarm from the keypad by using a widget or by tapping and holding the screen for 3 seconds when the screensaver or the slideshow is displayed.

**AUX.** [Medical alarm] – if this option is enabled, the user can trigger a medical alarm from the keypad by using a widget.

**3 wrong codes** [3 wrong codes] – if this option is enabled, entering incorrect code three times will trigger the alarm.

### ***Additional options***

**Silent PANIC alarm** [Silent panic] – if this option is enabled, the panic alarm triggered from the keypad will be a silent one, i.e. the keypad will not indicate it, there will be no audible signal, but the alarm will be reported to the monitoring station. The silent panic alarm is useful when the control panel is sending events to the monitoring station, but unauthorized persons should not be aware of the alarm being triggered. This option is available when the “PANIC” option is enabled.

**Sign. alarms** [Alarm signal.] – if this option is enabled, the keypad will signal alarms audibly.

**Keypress beep** [Key sound] – if this option is enabled, tapping the screen is confirmed by a sound.

**Sign. trbl. in part. arm** [Trbl.in p.arm.] – if this option is enabled, the  LED goes off after all partitions managed by the keypad are armed (if this option is disabled, the LED goes off after just one of the partitions is armed).

**Sign. new trouble** [New trbl. sign.] – if this option is enabled, the keypad will audibly signal the occurrence of a new trouble (if the “Trouble memory until review” option is enabled). New trouble signaling is cleared after the troubles have been reviewed by the user.

**Show code entering** [Show code ent.] – if this option is enabled, entering the code is presented on the keypad screen by asterisks.

**Exit delay clearing enable** [Fin.exit delay] – if this option is enabled, the user can shorten the exit delay time by using a widget or a function. The exit delay time can be shortened in partitions with the “Exit delay clearing” option enabled.

**Auto-Arm delay countdown** [Auto-arm delay] – if this option is enabled, the keypad informs the users about the auto-arm delay countdown in partition (message / sound).

**Show disarm messages** [Show disarming] – if this option is enabled, the keypad displays the disarming message irrespective of how the system has been disarmed. If this option is disabled, the keypad displays the disarming message only when the system has been disarmed from this keypad.

**Show arm messages** [Show arm] – if this option is enabled, the keypad displays the arming message. If this option is disabled, the arming message is not displayed.

**Quick control** [Control (8#)] – if this option is enabled, the user can control the outputs by using widgets without entering the user code.

**Zone**

**in LCD keypad** – if you select this option, the keypad zone will be supported.

**Not used** – if you select this option, the keypad zone will not be supported.

**Auto-backlight**

**Entry delay in part.** – if you select this option, the keypad will be woken up when the entry delay countdown begins in a selected partition.

**viol. of zone** – if you select this option, the keypad will be woken up when a selected zone is violated.

**no** – if you select this option, the keypad will be woken up only when the user taps the screen.

**Wake-up** – the way the keypad will respond to the wake-up (when the user taps the screen or a specified event occurs in the system):

**Screensaver** – screensaver will be displayed.

**User screen** – user home screen will be displayed.

**i** | *If you disable the screensaver (see option “No screensaver” p. 25), the user home screen will always be displayed after wake-up.*

**Tamper signaled in part.** [Tamper in part.] – partition where alarm will be triggered in the event of keypad tamper, triggering the alarm from keypad etc.

**Keypad data**

In the tab, you can configure the settings stored in the keypad. You can only configure them in the DLOADX program.

The buttons located on the bottom of the window apply to all settings that are stored in the keypad.

**Read** – click to read data from the keypad.



**Write** – click to write data to the keypad.

**Quit** – click to cancel the reading / writing of data.

**Reset** – click to restore the factory default settings of the keypad (this command applies to the settings presented in the “Keypad data” tab).

**Export to file** – click to export the keypad data to a file.

**Import from file** – click to import the keypad data from a file.

**i** | *Before you make any changes, click the “Read” button, and after you make the changes, click the “Write” button. The settings stored in the keypad are not read / written after you click  /  in the main menu.*

### Macro Commands

A macro command is a sequence of actions to be performed by the control panel. Configure a macro command and add it to the user screen as a widget. This will help the user to operate the alarm system. Instead of performing several operations (e.g. in order to arm selected partitions), the user can tap a widget to run a macro command, and the control panel will execute the functions assigned to the macro command.

**New macro** – click to create a new macro command.

**Remove macro** – click to delete a selected macro command.

**Name** – individual name of the macro command (up to 16 characters).

**Code** – code sent to the control panel when executing commands contained in the macro command. For execution of such commands to be possible, the code must be granted a suitable authority level. Click  to view the code.

 *If, when executing a macro command, it turns out that the code is invalid (e.g. it has been changed), the user will be asked to enter the correct code. It will be automatically saved to the keypad memory (replacing the invalid one).*

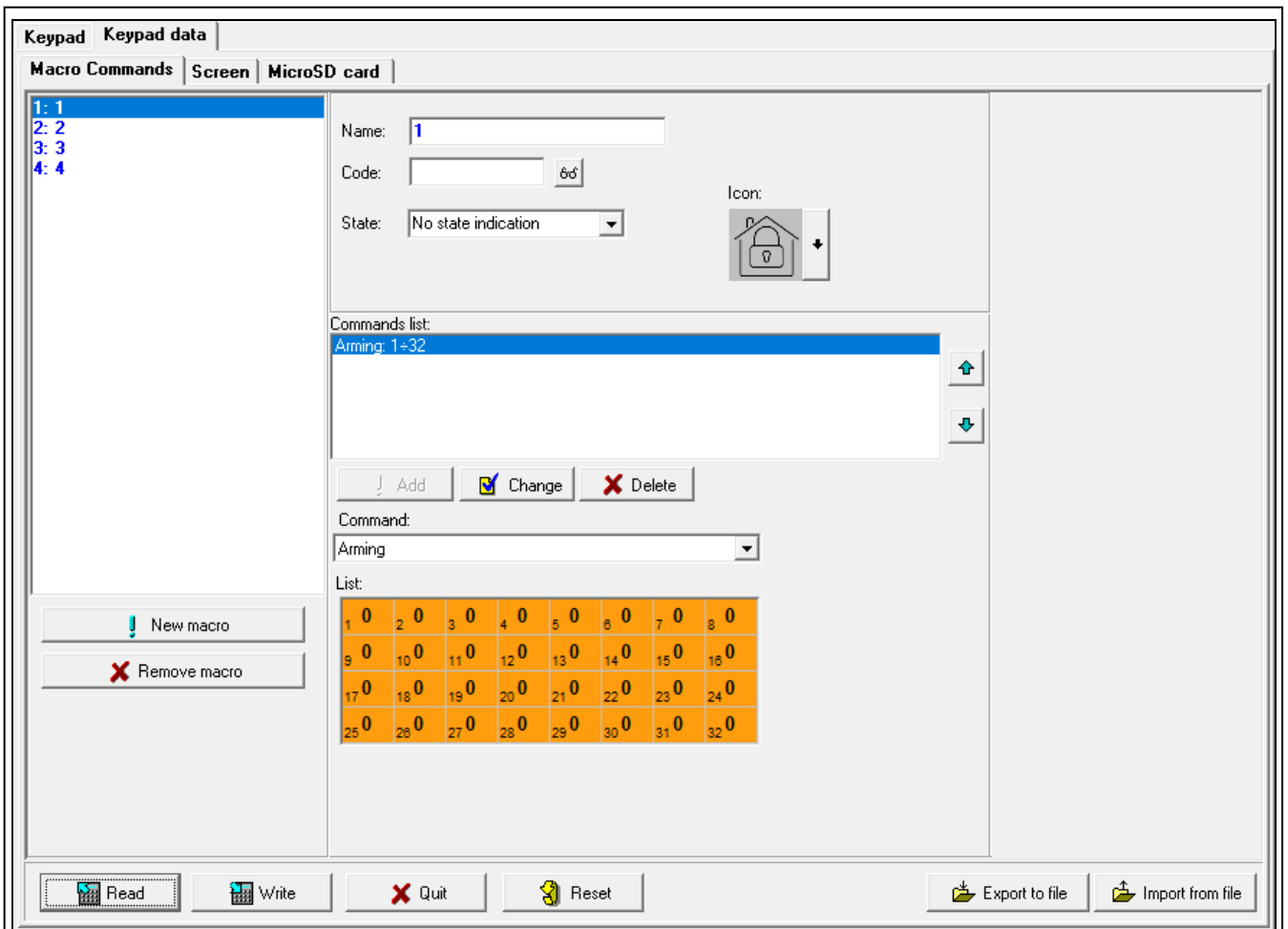

Fig. 20. DLOADX program: keypad in the INTEGRA system – “Macro command” tab (default settings).

**State** – widget can inform the user by means of icons about the state of selected alarm system elements (e.g. partition armed by a macro command or output controlled by a macro command).

**No state indication** – if you select this option, the widget will not indicate the state (only one icon will be used).

**State follow input** – if you select this option, the widget will indicate the state based on the zone state (two icons will be used).

**State follow output** – if you select this option, the widget will indicate the state based on the output state (two icons will be used).



**Zone** – widget indicates the state of this zone if you selected the “State follow input” option. Select the zone whose state will be affected by the macro command (e.g. zone that supervises the operation of a device turned on / off by a macro command).

**Output** – widget indicates the state of this output if you selected the “State follow output” option. Select the output whose state will be affected by the macro command (e.g. the “21: Armed status” type output which turns on after partition is armed).

**Icon** – pictogram used to represent a macro command on the screen. Click  to select a pictogram.

**Off** – pictogram used to represent a macro command on the screen when the widget indicates the inactive state. Click  to select a pictogram.

**Active** – pictogram used to represent a macro command on the screen when the widget indicates the active state. Click  to select a pictogram.

**Commands list** – commands assigned to the currently highlighted macro command. The  and  buttons allow you to change the order of commands (moving the selected command up and down).

**Add** – click to add to the list a new command selected in the “Command” field.

**Change** – click to save the changes to the command settings that were made after adding the command to the list (otherwise, the changes will not be saved).

**Delete** – click to remove the highlighted command from the list.

**Command** – function that you can assign to the macro command. Click  to drop down the list of available functions, then click the function that you want to assign to the macro command.



*The “KNX telegram” and “KNX telegram (v2)” functions allow you to control the KNX system if the INT-KNX or the INT-KNX-2 module is connected to the control panel.*

**List** – fields in this table represent the system elements (partitions / zones / outputs) that can be controlled by the function. The numbers of the fields in the table correspond to the numbers of the elements in the system. The color of the field indicates:

orange – function controls this system element,

white – function does not control this system element.

Double-click the field to change its color.

Depending on the selected function:

**Arming** – select the partitions to be armed and define the arming mode (successive clicks on the field). The digit inside the field indicates:

0 – fully armed,

1 – fully armed + bypasses,

2 – armed without interior,

3 – armed without interior and without entry delay.

**Disarming** – select the partitions to be disarmed.

**Alarm clearing** – select the partitions in which alarm is to be cleared.

**Bypass zones** – select the zones which are to be inhibited.

**Unbypass zones** – select the zones which are to be unbypassed.

**Outputs ON** – select the outputs to be activated.

**Outputs OFF** – select the outputs to be deactivated.

**Change outputs state** – select the outputs whose state is to be changed.



*The partitions must be controlled by user code.*

*The zones must not have the “Bypass disabled” option enabled.*

*The outputs must be the “24: MONO Switch”, “25: BI Switch”, “105: Shutter up”, “106: Shutter down” or “Remote switch” type (they do not need to be assigned to any group of outputs).*

**KNX telegram** – if you select this function, configure the following parameters of the KNX telegram:

**Module INT-KNX** – INT-KNX module to send the telegram.

**Group address** – group address that will be inserted in the telegram.

**Type** – telegram type.

**Value** – value that will be inserted in the telegram (parameter available for some types of the telegram).

**Priority** – telegram priority (if two elements of the bus start transmitting simultaneously, the telegram with higher priority will be sent first).

**KNX telegram (v2)** – if you select this function, configure the following parameters related to setting the value of the KNX communication object:

**Module INT-KNX** – INT-KNX-2 module in which the value is to be set.

**Macro Command** – name of the “Virtual (macro)” type object, defined in the INT-KNX-2 module.

**Data type** – size and meaning of the communication object data defined in INT-KNX-2 module for selected object.

**Value** – value to be set (if the type of data provides for sending a sequence of characters, you can enter up to 13 characters).

### Creating a macro command

1. Click the “Read” button to read the macro command settings from the keypad.
2. Click the “New macro” button. A new macro command will appear in the list.
3. Enter a name for the new macro command.
4. If the user is to run the macro command without entering the code, enter the code. You can create an additional user whose code will be used for this purpose. The user must be granted a suitable authority level in order to be able to run the functions that you want to assign to the macro command.
5. Specify if the widget displayed in the keypad is to show the state:
  - select the “No state indication” option if the widget is not to show the state,
  - select the “State follow input” or “State follow output” option if the widget is to show the state.
6. If you selected the “State follow input” / “State follow output” option, select the zone / output whose state is to control the widget icons.

7. Select the icon (if you select the “No state indication” option) / icons (if you selected the “State follow input” / “State follow output” option) that will be used to display the macro command on the screen.
8. Click  in the “Command” field and select from the list the function that will be executed by the new macro command.
9. Configure the command parameters (e.g. select the partitions to be disarmed).
10. Click the “Add” button. A new command will appear in the list of commands assigned to the macro command. Click the command whenever you want to make changes to its parameters. After making the changes, click the “Change” button.
11. Repeat the steps 8-10 if you want the macro command to execute more functions.
12. Click the “Write” button to write the macro command settings to the keypad.



*The user will be able to use the macro command if you add it to the user screen as a widget.*

## Screen

In the tab, you can prepare screens that will be used by the user for day to day operation of the alarm system from the keypad.



- click to add a user screen.



- click to delete the currently displayed user screen.



*To add an additional screen, first you need to add a link widget to the user screen.*

## Theme

A theme is a set of colors and background images to be used on the keypad screen.

**Selected theme** – name of the currently used theme.

**Font/icon color** – color used to display text and icons if an element is inactive.

**Font/icon highlight** – color used to display text and icons if an element is active.

**Background** – background color.

**Image** – name of the image used as background.

**Theme** – list of available themes. Click a theme to select it and see the preview.

**Select** – click if you want the theme currently selected from the list of available themes to be used in the keypad.

### Custom theme

To create a custom theme, select “Custom” from the list of available themes in the “Theme” field.

**Font/icon color** – color used to display text and icons if an element is inactive. Click  to drop down the list of available colors, then click the color that you want to use.

**Font/icon highlight** – color used to display text and icons if an element is active. Click  to drop down the list of available colors, then click the color that you want to use.

**Background** – background color. Click  to drop down the list of available colors, then click the color that you want to use.

**Image** – name of the image used as background. Click  to select an image from the list or add a new image. If you want to add a new image, click “From file...”, then indicate the JPG file. The program allows you to crop the added image to fit it to the keypad screen.



*If you add a new image, you must save it to the memory card that will be installed in the keypad (see “MicroSD card” p. 32).*

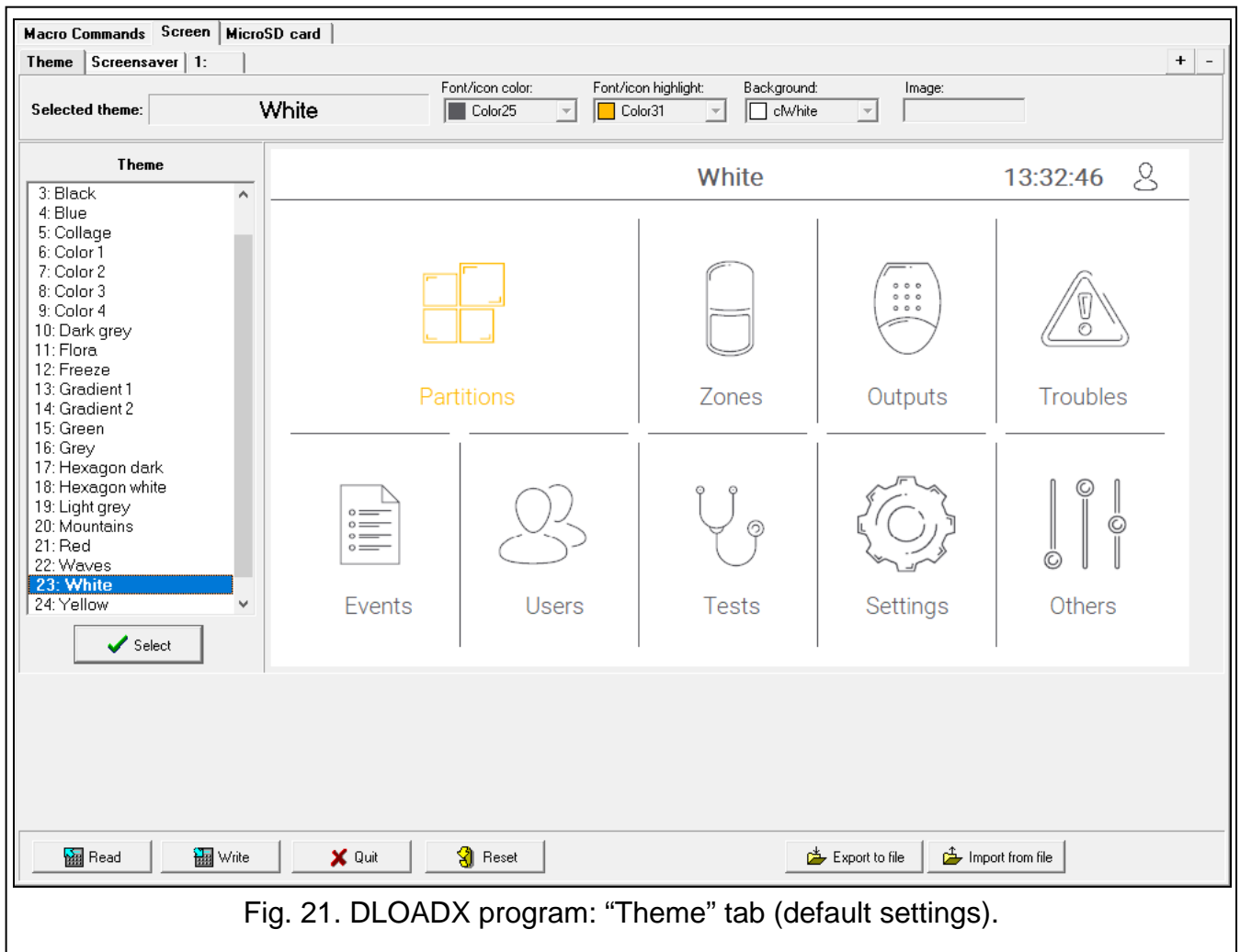

Fig. 21. DLOADX program: "Theme" tab (default settings).

### Screensaver / User screen / Additional screen

The screensaver can be displayed when the keypad is unused. It can display information about the alarm system status but it does not allow the user to operate the system. The user screens and the additional screens allow the user to operate the alarm system and control the automation equipment. They can also display information about the system status. To add an additional screen, first you will need to add a link widget to the user screen (the user will be able to go to the user screen by tapping the widget). The user screens can have two different background images (including the screensaver background image). The additional screens, however, can each have a different background image. For this reason, the additional screens may be used to display site plans (prepare an image file containing a site plan and use it as background, then add to it widgets that will indicate the state of system elements: partitions, zones or outputs).

**Name** – screen name. If entered, it will be displayed on the screen status bar. This field is not available for screensaver.

**No screensaver** – if this option is enabled, the screensaver is disabled (it is not displayed). This option is available only for the screensaver.



*If the screensaver is disabled, the slideshow is not available.*

**No clock** – if this option is enabled, the default clock is not displayed on the screensaver. This option is available only for the screensaver.

**Home screen** – if this option is enabled, the user screen is selected as the home screen, i.e. one that is displayed first. This option is available only for user screen. It can be enabled for one user screen only.

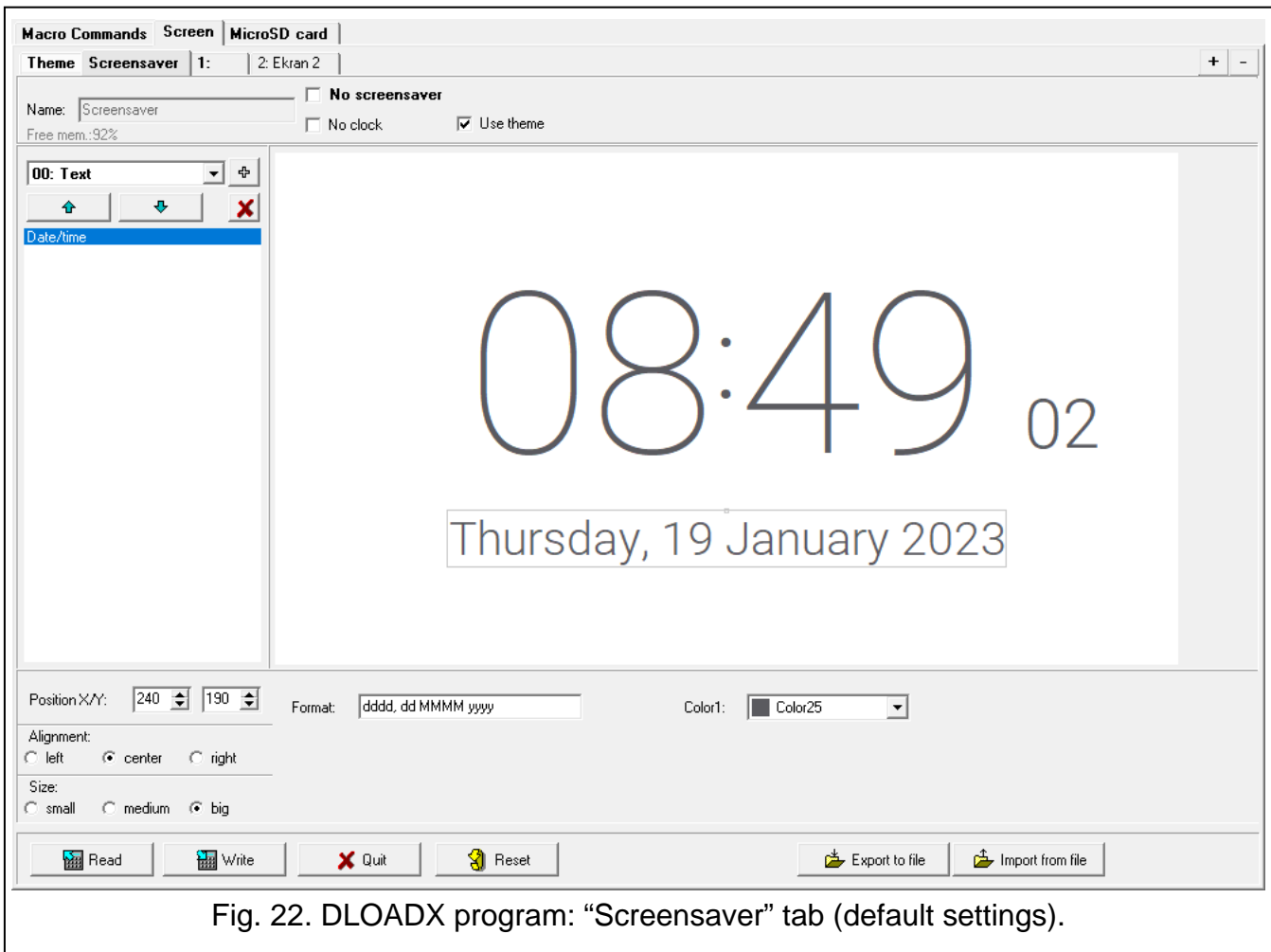



Fig. 22. DLOADX program: “Screensaver” tab (default settings).

**Show grid** – if this option is enabled, grid is displayed on the screen. This option is available only for user screen.

**Available after logging in** – if this option is enabled, the user has to enter code to access the screen. This option is available for user screen and additional screen.

**Use theme** – if this option is enabled, the theme selected in the “Theme” tab is used. If this option is disabled, you can select the colors and background image for the screensaver / screen.

**Font/icon color** – color used to display text and icons if an element is inactive. Click  to drop down the list of available colors, then click the color that you want to use. This field is displayed if the “Use theme” option is disabled.

**Font/icon highlight** – color used to display text and icons if an element is active. Click  to drop down the list of available colors, then click the color that you want to use. This field is displayed if the “Use theme” option is disabled.

**Background** – background color. Click  to drop down the list of available colors, then click the color that you want to use. This field is displayed if the “Use theme” option is disabled.

**Image** – name of the image used as background. Click  to select an image from the list or add a new image. If you want to add a new image, click “From file...”, then indicate the JPG file. The program allows you to crop the added image to fit it to the keypad screen. This field is displayed if the “Use theme” option is disabled.



*If you add a new image, you must save it to the memory card that will be installed in the keypad (see “MicroSD card” p. 32).*

For screensaver and user screens, you can use the background image defined in the theme or, if you disable the “Use theme” option, an image selected by you. Only one additional image can be selected. If you select it for the screensaver, you will not be able to select another image for the user screens. The selection list available after you click [...] will consist of only one selectable item (if you previously selected an image from a file, this item will be named “Custom”).

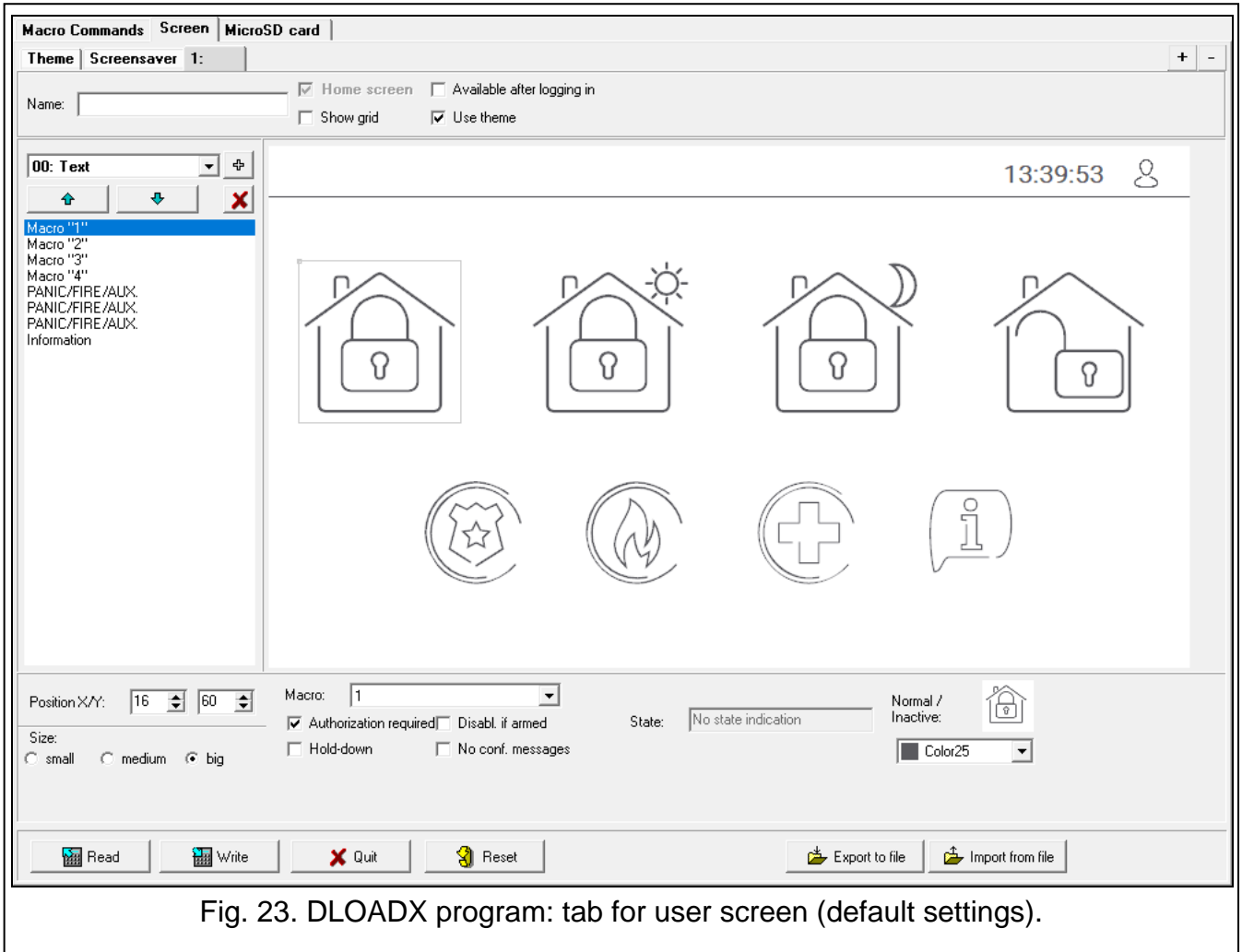

Fig. 23. DLOADX program: tab for user screen (default settings).

**[Widget]** – widget that you can add to the screen. Click ▼ to drop down the list of available widgets, then select the widget that you want to add.

**Text** – widget displays a text that you entered or the name of a system element.

**Partition state** – widget shows the partition state.

**Zone state** – widget shows the zone state.

**Output state** – widget shows the output state.

**Temperature** – widget displays temperature. Information about temperature is obtained from an ABAX 2 / ABAX wireless device.

**Date/time** – widget displays date and time.

**Switch** – widget used to turn on / off an output.

**Rectangle** – widget displays a rectangle on the screen.

**Macro** – widget used to run a macro command.

**PANIC/FIRE/AUX.** – widget used to trigger a panic / fire / medical alarm.

**Information** – widget used to display a message that you entered.

**Link** – widget allows the user to go to additional screen / return to user screen.

**Button** – the widget offers two functions:

tap – the user can tap the widget to turn on / off an output.

tap and hold – the user can tap and hold the widget to turn on an output. The output will remain on as long as the user holds the widget. When the user takes his finger off the widget, the output will be turned off.

**Analog value** – widget displays information on the power consumption of the appliance connected to the ASW-200 smart plug.

**Thermostat** – widget is used to adjust the temperature settings for the thermostatic output.

 - click to add the widget selected in the field on the left. It will be placed on the preview screen on the right.

 - click to move the widget up on the list.

 - click to move the widget down on the list.

 - click to delete the selected widget.

**[Preview]** – preview shows what the user will see on the keypad screen. Use the “drag and drop” method to move widgets around the screen. Alternatively, you can use the arrow keys to move a selected widget.

### “Text” widget settings

**Position X/Y** – position of the widget on the screen.

**Type** – type of information displayed by the widget. Click  to select:

**Text** – widget displays a text that you entered.

**This keypad name** – widget displays the keypad name.

**Part. name** – widget displays the partition name.

**Zone name** – widget displays the zone name.

**Output name** – widget displays the output name.

**Module name** – widget displays the expansion module name.

**Keypad name** – widget displays the keypad name.

**Timer name** – widget displays the timer name.

**Text** – text to be displayed by the widget. This field is available if you selected the “Text” type.

**Part. name** – partition whose name is displayed by the widget. Click  to select a partition. This field is available if you selected the “Part. name” type.

**Zone name** – zone whose name is displayed by the widget. Click  to select a zone. This field is available if you selected the “Zone name” type.

**Output name** – output whose name is displayed by the widget. Click  to select an output. This field is available if you selected the “Output name” type.

**Module name** – module whose name is displayed by the widget. Click  to select a module. This field is available if you selected the “Module name” type.

**Keypad name** – keypad whose name is displayed by the widget. Click  to select a keypad. This field is available is you selected the “Keypad name” type.

**Timer name** – timer whose name is displayed by the widget. Click  to select a timer. This field is available if you selected the “Timer name” type.

**Color1** – color of the widget. Click  to select a color.

**Size** – size of the widget on the screen. Select one of three available sizes.

### “Partition state” widget settings

**Position X/Y** – position of the widget on the screen.

**Partition** – partition whose state is presented by the widget. Click  to select a partition.

**Size** – size of the widget on the screen. Select one of three available sizes.

### “Zone state” widget settings

**Position X/Y** – position of the widget on the screen.

**Type** – the way the zone state is presented. Click  to select:

**Indicator** – zone state is presented by icons selected by SATEL. The widget will display different states.

**Text** – zone state is presented by text messages. You can enter messages of your choice. The widget will only display normal state and violation.

**Icon** – zone state is presented by icons you choose. The widget will only display normal state and violation.

**Zone** – zone whose state is presented by the widget. Click  to select a zone.

**Normal state** – text / icon displayed when the zone is in normal state. This field is available if you selected the “Text” / “Icon” type.

**Violation** – text / icon displayed when the zone is violated. This field is available if you selected the “Text” / “Icon” type.

**Color1** – color of the widget when zone is in normal state. Click  to select a color.

**Color2** – color of the widget when zone is violated. Click  to select a color.

**Alignment** – text alignment. The text can be left-aligned, centered or right-aligned. This parameter is available if you selected the “Text” type.

**Size** – size of the widget on the screen. Select one of three available sizes.

### “Output state” widget settings

**Position X/Y** – position of the widget on the screen.

**Type** – the way the output state is presented. Click  to select:

**Indicator** – output state is presented by icons selected by SATEL.

**Text** – output state is presented by text messages. You can enter messages of your choice.

**Icon** – output state is presented by icons you choose.

**Output** – output whose state is presented by the widget. Click  to select an output.

**Off** – text / icon displayed when the output is turned off. This field is available if you selected the “Text” / “Icon” type.

**Active** – text / icon displayed when the output is turned on. This field is available if you selected the “Text” / “Icon” type.

**Color1** – color of the widget when the output is turned off. Click  to select a color.

**Color2** – color of the widget when the output is turned on. Click  to select a color.

**Alignment** – text alignment. The text can be left-aligned, centered or right-aligned. This parameter is available if you selected the “Text” type.

**Size** – size of the widget on the screen. Select one of three available sizes.

### “Temperature” widget settings

**Position X/Y** – position of the widget on the screen.

**Zone** – zone to which the ABAX 2 / ABAX wireless device providing temperature information is assigned. Click  to select a zone.

°C – if you select this option, temperatures will be expressed in degrees Celsius.

°F – if you select this option, temperatures will be expressed in degrees Fahrenheit.

**Color1** – color of the widget. Click  to select a color.

**Alignment** – text alignment. The text can be left-aligned, centered or right-aligned.

**Size** – size of the widget on the screen. Select one of three available sizes.

### “Date/time” widget settings

**Position X/Y** – position of the widget on the screen.

**Format** – the way that date and time is displayed. Use the following characters to define the date and time format (the number of letters affects what information is displayed):

**d** – day/date (1 to 6 letters),

**M** – month (1 to 4 letters),

**y** – year (1 to 3 letters),

**s** – seconds (1 to 2 letters),

**m** – minutes (1 to 2 letters),

**h** – hour (1 to 2 letters),

**t** – time (1 to 2 letters),

**c** – date and time.

**Color1** – color of the widget. Click  to select a color.

**Size** – size of the widget on the screen. Select one of three available sizes.

**Alignment** – text alignment. The text can be left-aligned, centered or right-aligned.

### “Switch” widget settings

**Position X/Y** – position of the widget on the screen.

**Control output** – output controlled by the widget. Click  to select an output (select a controllable output).

**Off** – icon displayed when the output is turned off. Click  to select a pictogram.

**Active** – icon displayed when the output is turned on. Click  to select a pictogram.

**Color1** – color of the widget when the output is turned off. Click  to select a color.

**Color2** – color of the widget when the output is turned on. Click  to select a color.

**Size** – size of the widget on the screen. Select one of three available sizes.

### “Rectangle” widget settings

**Position X/Y** – position of the widget on the screen.

**Transparency** – scale to determine the degree of transparency of the rectangle.

**Color** – fill color of the rectangle. Click  to select a color.

**Frame color** – color of the frame around the rectangle. Click  to select a color.

**Thickness** – thickness of the frame around the rectangle.

**Size W/H** – rectangle size in pixels (width / height).

### “Macro” widget settings

**Position X/Y** – position of the widget on the screen.

**Macro** – macro command run by the widget. Click  to select a macro command (you need to create the macro command first – see “Macro Commands” p. 21).

**Authorization required** – if this option is enabled, the macro command is executed only after the user enters the code.

**Disabl. if armed** – if this option is enabled, the macro command is not available if any of the partitions supported by the keypad is armed.

**Hold-down** – if this option is enabled, the user is to tap and hold the widget for 3 seconds to run the macro command.

**Log out after execution** – if the option is enabled, the user will be logged out after executing the macro command (even if the control panel fails to perform the functions assigned to the macro command). If the option is disabled, after executing a macro command that required the user to enter a code, the user will be logged in.

**State** – information about the “State” parameter setting in the “Macro Commands” tab.

**Zone** – information about the “Zone” parameter setting in the “Macro Commands” tab.

**Output** – information about the “Output” parameter setting in the “Macro Commands” tab.

**Normal / Inactive** – pictogram selected for the macro command in the “Macro Commands” tab (fields “Icon” or “Off”). You can select its color in the field below.

**Active** – pictogram selected for the macro command in the “Macro Commands” tab (field “Active”). You can select its color in the field below.

**Size** – size of the widget on the screen. Select one of three available sizes.

#### “PANIC/FIRE/AUX.” widget settings

**Position X/Y** – position of the widget on the screen.

**Type** – type of alarm that will be triggered when the widget is run (“PANIC alarm” / “FIRE alarm” / “MEDICAL alarm”). Click  to select a type.

**Color1** – color of the widget. Click  to select a color.

**Size** – size of the widget on the screen. Select one of three available sizes.

#### “Information” widget settings

**Position X/Y** – position of the widget on the screen.

**Message** – message that will be displayed when the widget is run.

**Size** – size of the widget on the screen. Select one of three available sizes.

#### “Link” widget settings

**Position X/Y** – position of the widget on the screen.

**Link** – response to tapping on the widget. Click  to select:

**Return** – user screen will be displayed.

**[name of additional screen]** – selected additional screen will be displayed.

**New additional screen** – click to add an additional screen.

**Icon** – pictogram used to display the link on the screen. Click  to select a pictogram.

**Color1** – color of the widget when inactive. Click  to select a color.

**Color2** – color of the widget when active. Click  to select a color.

**Size** – size of the widget on the screen. Select one of three available sizes.

#### “Button” widget settings

**Position X/Y** – position of the widget on the screen.

**Control output** – output controlled by the widget. Click  to select an output (select a controllable output).



The „Remote switch” type output (INTEGRA series control panels) should have the cut-off time programmed to 0.

**Off** – icon displayed when the output is turned off. Click  to select a pictogram.

**Active** – icon displayed when the output is turned on. Click  to select a pictogram.

**Color1** – color of the widget when the output is turned off. Click  to select a color.

**Color2** – color of the widget when the output is turned on. Click  to select a color.

**Size** – size of the widget on the screen. Select one of three available sizes.

#### “Analog value” widget settings

**Position X/Y** – position of the widget on the screen.

**Output** – output to which the ASW-200 smart plug is assigned. The widget displays information on the power consumption of the appliance connected to the ASW-200 smart plug. Click  to select an output.

**Text** – value details (e.g. unit of measure). It is displayed after the value (on the right).

**Color1** – color of the widget. Click  to select a color.

**Alignment** – text alignment. The text can be left-aligned, centered or right-aligned.

**Size** – size of the widget on the screen. Select one of three available sizes.

#### “Thermostat” widget settings

**Position X/Y** – position of the widget on the screen.

**Thermostat output** – “120. Thermostat” type output whose settings can be adjusted when the user taps the widget. Click  to select an output.

**Color1** – color of the widget when the output is turned off. Click  to select a color.

**Color2** – color of the widget when the output is turned on. Click  to select a color.

**Size** – size of the widget on the screen. Select one of three available sizes.

### **MicroSD card**

In the tab you can prepare additional images to be saved on the memory card.

**Save to SD card** – click to save the prepared image files to the memory card.

#### Images/backgrounds

The tab displays the background images you added from a file while creating screens in the “Screen” tab. This tab is available if any of the screens uses a background image added by you from a file.

**Show SD card content** – if the option is enabled, background images already saved on the SD card are displayed in the tab (after enabling the option, indicate the path to the SD card).

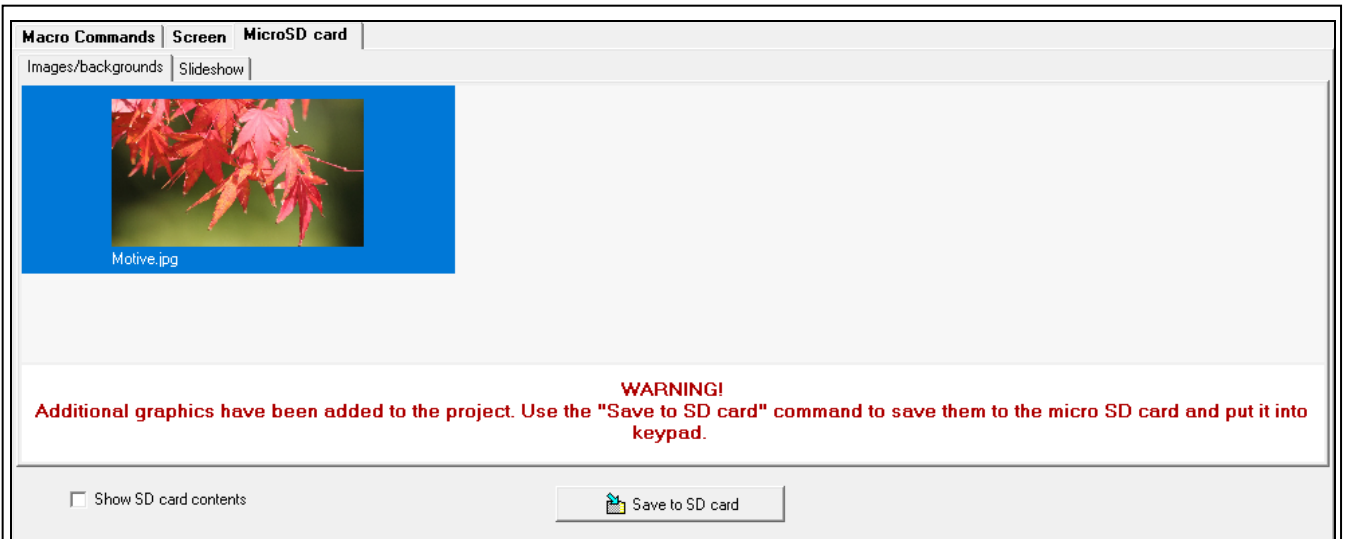

Fig. 24. DLOADX program: “Images/backgrounds” tab (example).

***Slideshow***

In the tab, you can prepare a set of images for a slideshow in the keypad.

**Add** – click to add a new image to the slideshow.

**Delete** – click to delete a selected image from the slideshow.

**Clear** – click to delete all images.

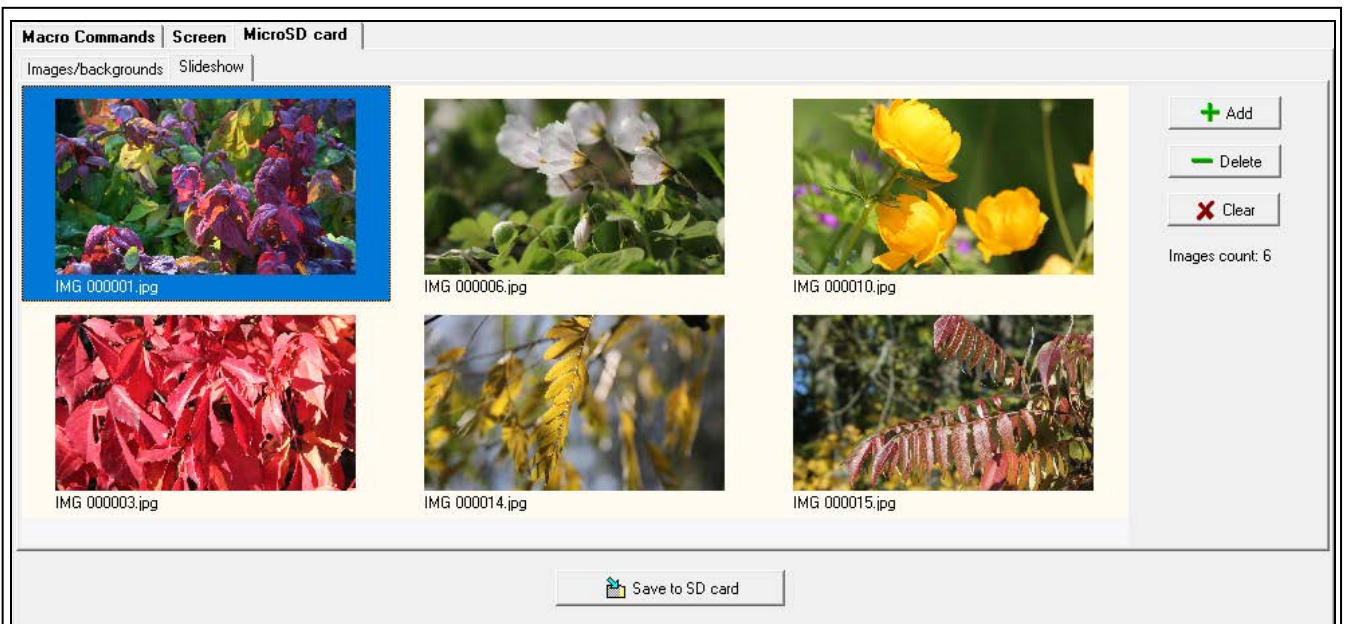

Fig. 25. DLOADX program: “Slideshow” tab (example).

***EOL resistance value***

In the tab you can program the EOL resistance value if the keypad is connected to the INTEGRA control panel.



*In the INTEGRA Plus control panel, you can define the EOL resistance value for the mainboard zones. The same resistors must be used for all zones for which the EOL resistance value is programmable (including the keypad zones).*

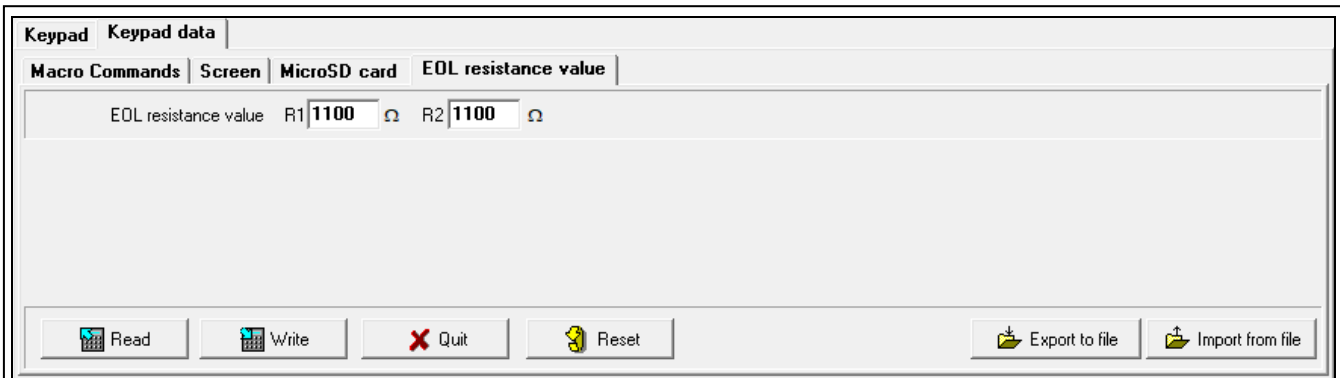

Fig. 26. DLOADX program: “EOL resistance value” tab (default settings).

**R1** – value of the R1 resistor (see Fig. 27). You can enter values from 500  $\Omega$  to 15 k $\Omega$ . By default: 1.1 k $\Omega$ .

**R2** – value of the R2 resistor (see Fig. 27). You can enter values from 500  $\Omega$  to 15 k $\Omega$  or 0. If you enter 0, the value of resistors used in the Double EOL configuration must be equal to half the value programmed for the R1 resistor (the value of one resistor must not be less than 500  $\Omega$ ). By default: 1.1 k $\Omega$ .



*The resistor value for Single EOL configuration is the sum of R1 and R2 resistors.*

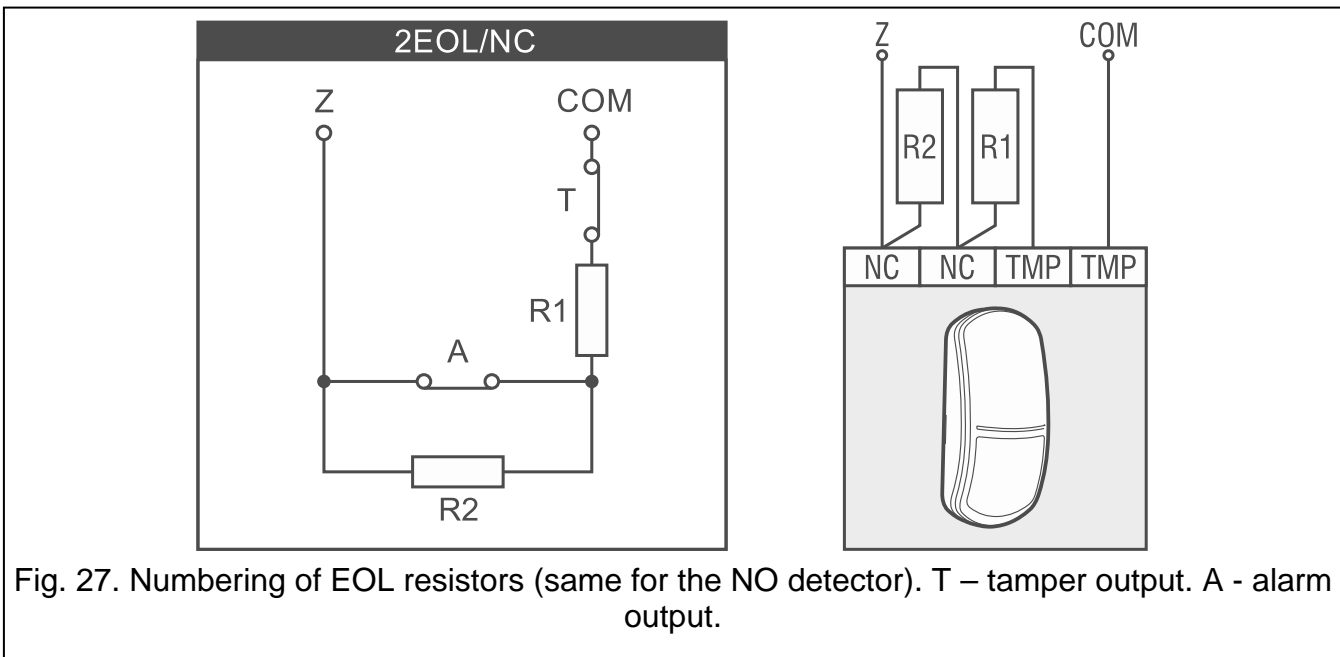

Fig. 27. Numbering of EOL resistors (same for the NO detector). T – tamper output. A - alarm output.

## 6.2 Keypad in the PERFECTA 64 M system

You can configure all the keypad settings from the computer with the PERFECTA SOFT program installed. Using the keypad, you can configure only some of the settings. Names of parameters and options from the PERFECTA SOFT program are used in this manual.

### 6.2.1 Programming with the PERFECTA SOFT program



Required version of the PERFECTA SOFT program: 2.00 (or newer).

1. Click the “Hardware” tab.
2. Click the name of the keypad whose settings you want to configure.
3. Configure the keypad settings.

- Click  to save changes to the control panel. For settings stored in the keypad (“Screen” tab), click the “Write” button.

### 6.2.2 Programming from the keypad

- Start the service mode (see “Starting the service mode in the PERFECTA 64 M system” p. 9).

- Tap  . The list of functions available in the “2.Expanders” submenu will be displayed.

- Configure the keypad settings using the available functions.

### 6.2.3 Keypad settings

In square brackets you will find one of the following information

- name of the function used to configure a parameter or option in the keypad,
- name of a parameter or option from the keypad.

### Keypad

**Name** [28.Names] – individual name of the keypad (up to 16 characters).

**Alarm in part.** [22.Partitions] – the partition in which alarm will be triggered in the event of keypad tamper (opening of enclosure or loss of communication).

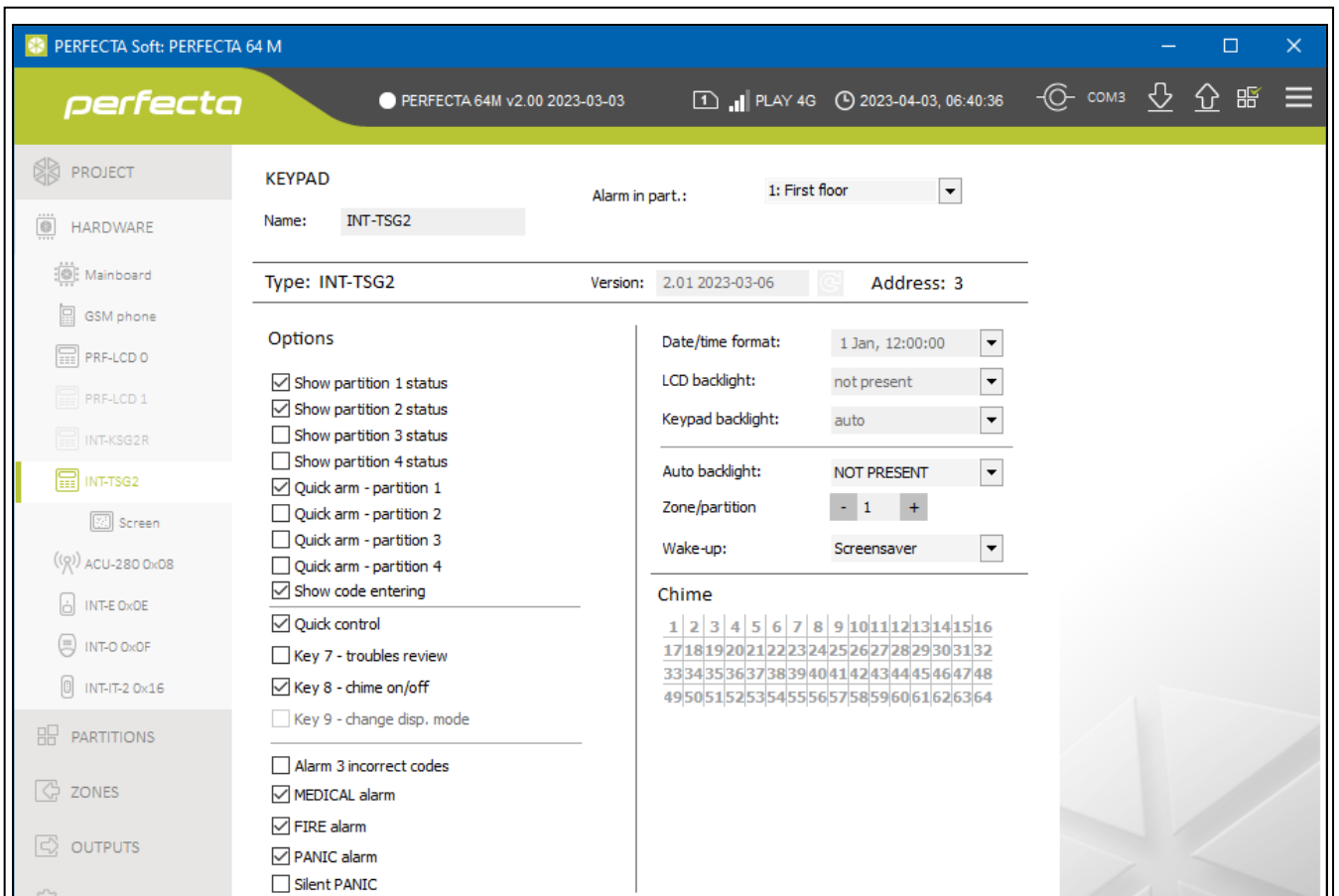

Fig. 28. PERFECTA SOFT program: keypad settings (example).

### Options

**Show partition 1 status** [Show part.1] – if this option is enabled, the keypad indicates the status of partition 1 (display / LED indicators / audible signal).

**Show partition 2 status** [Show part.2] – if this option is enabled, the keypad indicates the status of partition 2 (display / LED indicators / audible signal).

**Show partition 3 status** [Show part.3] – if this option is enabled, the keypad indicates the status of partition 3 (display / LED indicators / audible signal).

**Show partition 4 status** [Show part.4] – if this option is enabled, the keypad indicates the status of partition 4 (display / LED indicators / audible signal).

**Quick arm - partition 1** [Quickarm part.1] – if this option is enabled, the user can arm partition 1 from the keypad without using code.

**Quick arm - partition 2** [Quickarm part.2] – if this option is enabled, the user can arm partition 2 from the keypad without using code.

**Quick arm - partition 3** [Quickarm part.3] – if this option is enabled, the user can arm partition 3 from the keypad without using code.

**Quick arm - partition 4** [Quickarm part.4] – if this option is enabled, the user can arm partition 4 from the keypad without using code.

**Show code entering** [Show code enter.] – if this option is enabled, entering the code is presented on the display by asterisks.

**Quick control** [Quick control] – if this option is enabled, the user can control the outputs without entering the code:

- using widgets,
- using the number keys on terminal. The “15. Controlled” type outputs should be assigned to keys (see the control panel programming manual).

**Key 7 - troubles review** [Troubles review] – if this option is enabled, the user can view the

troubles by tapping and holding the  key of the terminal for 3 seconds.

**Key 8 - chime on/off** [Chime on/off] – if this option is enabled, the user can turn on / off the

CHIME signal by tapping and holding the  key of the terminal for 3 seconds.

**Alarm 3 incorrect codes** [3 wrng codes al.] – if this option is enabled, entering incorrect code three times will trigger the alarm.

**MEDICAL alarm** [Medical alarm] – if this option is enabled, the user can trigger a medical alarm from the keypad by using a widget or from the terminal (by tapping and holding the

 key for 3 seconds).

**FIRE alarm** [Fire alarm] – if this option is enabled, the user can trigger a fire alarm from the

keypad by using a widget or from the terminal (by tapping and holding the  key for 3 seconds).

**PANIC alarm** [Panic alarm] – if this option is enabled, the user can trigger a panic alarm from

the keypad by using a widget, from the terminal (by tapping and holding the  key for 3 seconds) or by tapping and holding the screen for 3 seconds when the screensaver or the slideshow is displayed.

**Silent PANIC** [Silent panic] – if this option is enabled, the panic alarm triggered from the keypad will be a silent one, i.e. the keypad will not indicate it, there will be no audible signal, but the alarm will be reported to the monitoring station. The silent panic alarm is useful when the control panel is sending events to the monitoring station, but unauthorized persons should not be aware of the alarm being triggered. The option is available, if the “PANIC alarm” option is enabled.

## Display

**Auto backlight** [29.Autolight] – rules for additional keypad wake-up:

**Not present** – if you select this option, the keypad will be woken up only when the user taps the screen.

**Zone violation** – if you select this option, the keypad will be woken up when a selected zone is violated.

**Entry delay in part.** – if you select this option, the keypad will be woken up when the entry delay countdown begins in a selected partition.



*If the entry delay in a partition is to wake-up the keypad, the keypad must indicate the status of this partition.*

**Wake-up** – the way the keypad will respond to the wake-up (after a tap on the screen by the user or occurrence of a specified event in the system):

**Screensaver** – screensaver will be displayed.

**User screen** – user home screen will be displayed.



*If you disable the screensaver (see option “No screensaver” p. 39), the user home screen will always be displayed after wake-up.*

## Chime

The keypad can audibly signal violation of selected zones.

## Screen

In the tab, you can prepare screens that will be used by the user for day to day operation of the alarm system from the keypad. The settings available in the tab are stored in the keypad. You can only configure them in the PERFECTA SOFT program.

- click to add a user screen.

- click to delete the currently displayed user screen.

## Buttons

**Read** – click to read data from the keypad (all settings stored in the keypad).

**Write** – click to write data to the keypad (all settings stored in the keypad).

**Quit** – click to cancel the reading / writing of data.

**Reset** – click to restore the factory default settings of the keypad (this command applies to the settings stored in the keypad).

**Macro Commands** – click to open the “Macro Commands” window.

**SD card** – click to open the “Save to SD card” window.

**Import from file** – click to import the keypad data from a file.

**Export to file** – click to export the keypad data to a file.



*Before you make any changes, click the “Read” button, and after you make the changes, click the “Write” button. The settings stored in the keypad are not read / written after you click / on the menu bar.*

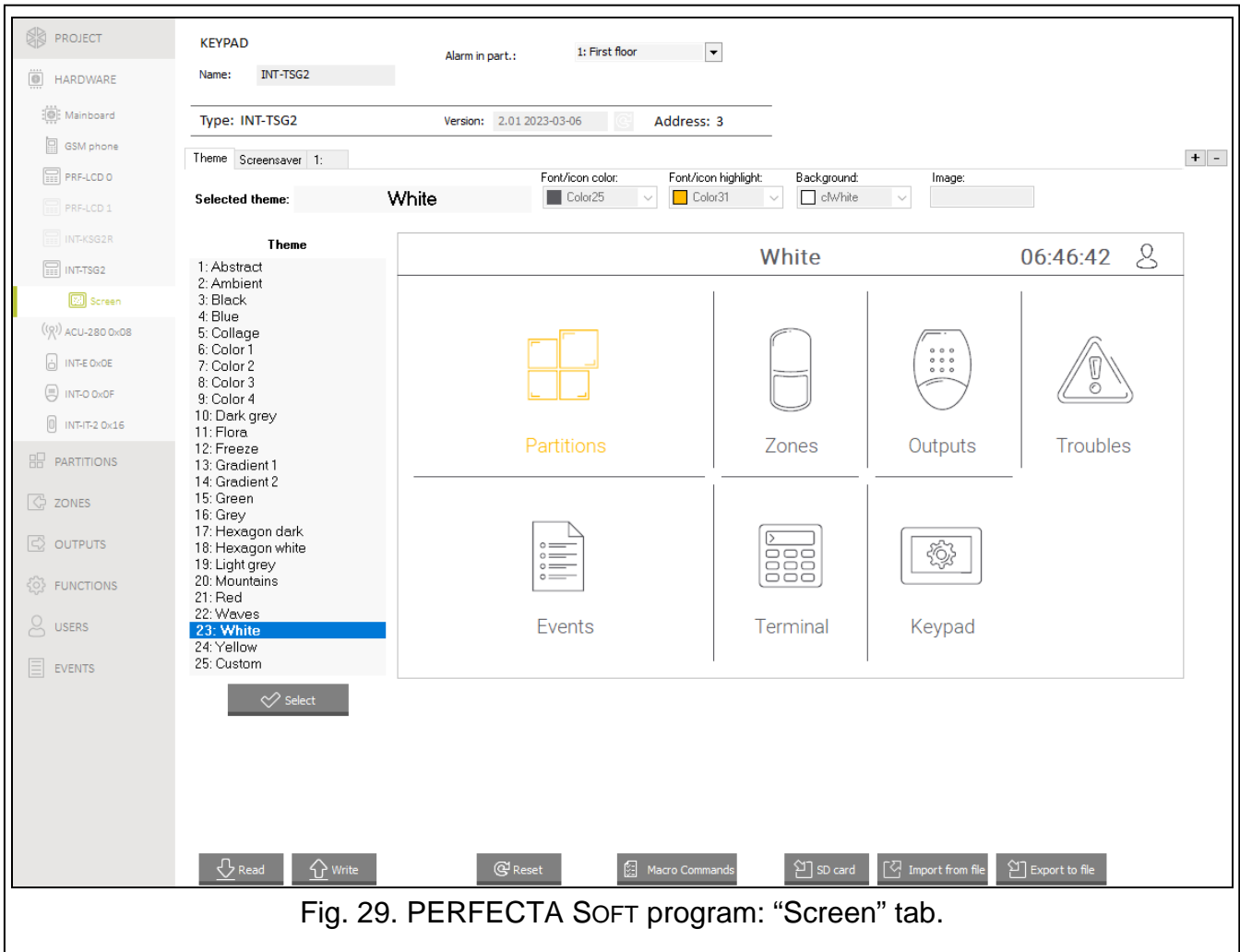

Fig. 29. PERFECTA SOFT program: "Screen" tab.

## Theme

A theme is a set of colors and background images to be used on the keypad screen.

**Selected theme** – name of the currently used theme.

**Font/icon color** – color used to display text and icons if an element is inactive.

**Font/icon highlight** – color used to display text and icons if an element is active.

**Background** – background color.

**Image** – name of the image used as background.

**Theme** – list of available themes. Click a theme to select it and see the preview.

**Select** – click if you want the theme currently selected from the list of available themes to be used in the keypad.

## Custom theme

To create a custom theme, select "Custom" from the list of available themes in the "Theme" field.

**Font/icon color** – color used to display text and icons if an element is inactive. Click  to drop down the list of available colors, then click the color that you want to use.

**Font/icon highlight** – color used to display text and icons if an element is active. Click  to drop down the list of available colors, then click the color that you want to use.

**Background** – background color. Click  to drop down the list of available colors, then click the color that you want to use.

**Image** – name of the image used as background. Click  to select an image from the list or add a new image. If you want to add a new image, click “From file...”, then indicate the JPG file. The program allows you to crop the added image to fit it to the keypad screen.

 *If you add a new image, you must save it to the memory card that will be installed in the keypad (see “Save to SD card” p. 49).*

**Screensaver / User screen / Additional screen**

The screensaver can be displayed when the keypad is unused. It can display information about the alarm system status but it does not allow the user to operate the system. The user screens and the additional screens allow the user to operate the alarm system and control the automation equipment. They can also display information about the system status. To add an additional screen, first you will need to add a link widget to the user screen (the user will be able to go to the user screen by tapping the widget). The user screens can have two different background images (including the screensaver background image). The additional screens, however, can each have a different background image. For this reason, the additional screens may be used to display site plans (prepare an image file containing a site plan and use it as background, then add to it widgets that will indicate the state of system elements: partitions, zones or outputs).

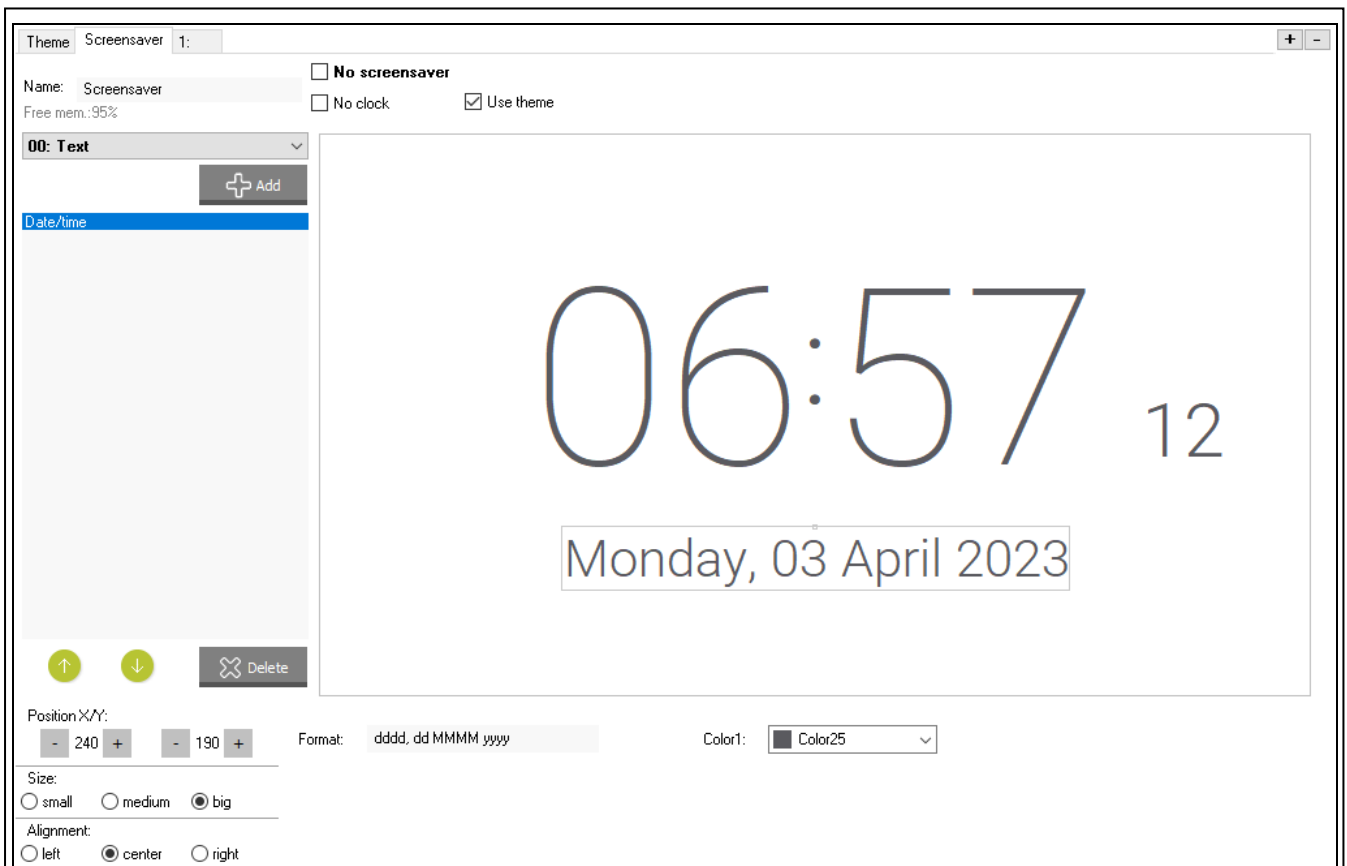

Fig. 30. PERFECTA SOFT program: “Screensaver” (default settings).

**Name** – screen name. If entered, it will be displayed on the screen status bar. This field is not available for screensaver.

**No screensaver** – if this option is enabled, the screensaver is disabled (it is not displayed). This option is available only for the screensaver.

 *If the screensaver is disabled, the slideshow is not available.*

**No clock** – if this option is enabled, the default clock is not displayed on the screensaver.

This option is available only for the screensaver.

**Home screen** – if this option is enabled, the user screen is selected as the home screen, i.e. one that is displayed first. This option is available only for user screen. It can be enabled for one user screen only.

**Show grid** – if this option is enabled, grid is displayed on the screen. This option is available only for user screen.

**Available after logging in** – if this option is enabled, the user has to enter code to access the screen. This option is available for user screen and additional screen.

**Use theme** – if this option is enabled, the theme selected in the “Theme” tab is used. If this option is disabled, you can select the colors and background image for the screensaver / screen.

**Font/icon color** – color used to display text and icons if an element is inactive. Click  to drop down the list of available colors, then click the color that you want to use. This field is displayed if the “Use theme” option is disabled.

**Font/icon highlight** – color used to display text and icons if an element is active. Click  to drop down the list of available colors, then click the color that you want to use. This field is displayed if the “Use theme” option is disabled.

**Background** – background color. Click  to drop down the list of available colors, then click the color that you want to use. This field is displayed if the “Use theme” option is disabled.

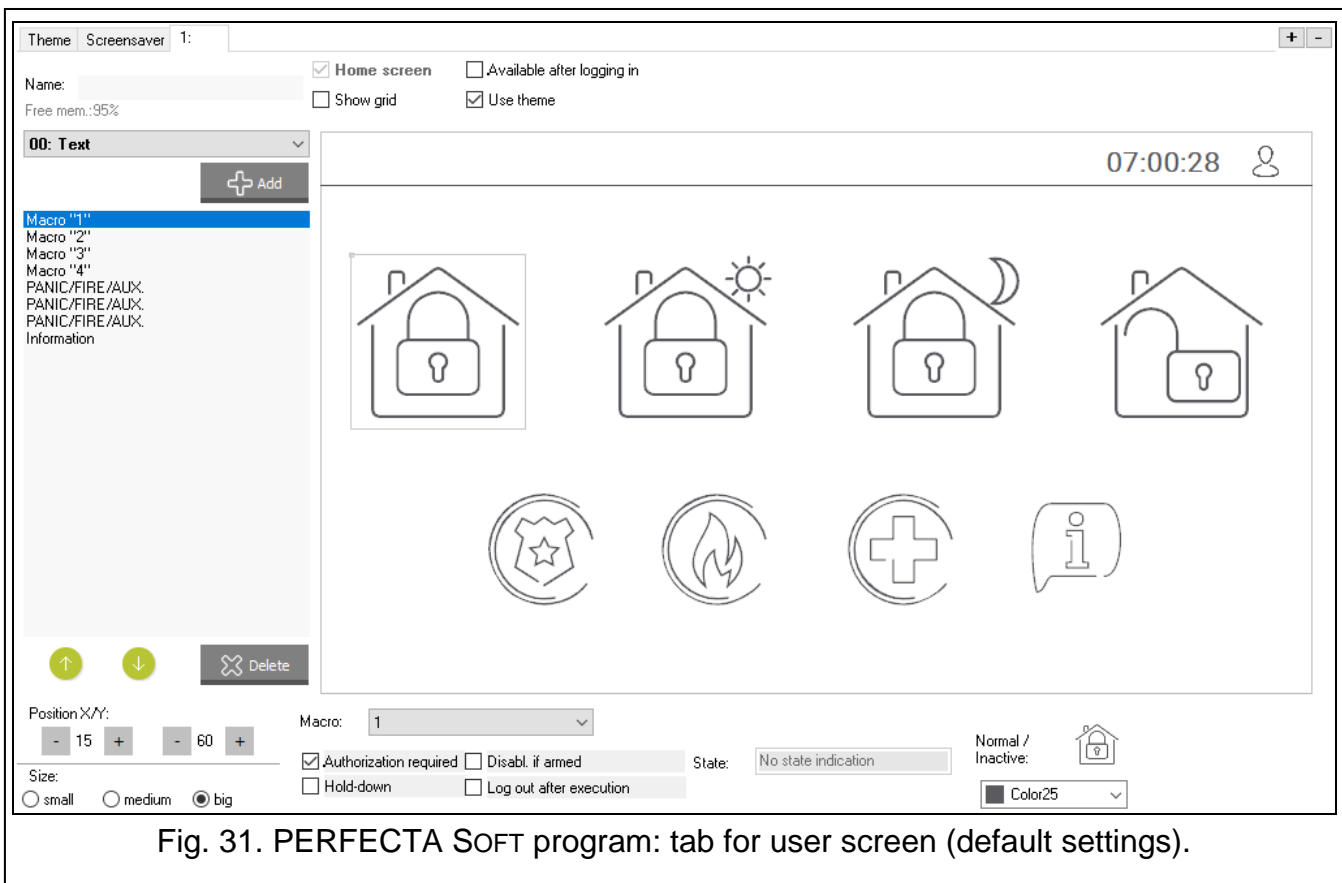





Fig. 31. PERFECTA SOFT program: tab for user screen (default settings).

**Image** – name of the image used as background. Click  to select an image from the list or add a new image. If you want to add a new image, click “From file...”, then indicate the JPG file. The program allows you to crop the added image to fit it to the keypad screen. This field is displayed if the “Use theme” option is disabled.



*If you add a new image, you must save it to the memory card that will be installed in the keypad (see “Save to SD card” p. 49).*

*For screensaver and user screens, you can use the background image defined in the theme or, if you disable the “Use theme” option, an image selected by you. Only one additional image can be selected. If you select it for the screensaver, you will not be able to select another image for the user screens. The selection list available after you click  will consist of only one selectable item (if you previously selected an image from a file, this item will be named “Custom”).*

**[Widget]** – widget that you can add to the screen. Click  to drop down the list of available widgets, then select the widget that you want to add.

**Text** – widget displays a text that you entered or the name of a system element.

**Partition state** – widget shows the partition state.

**Zone state** – widget shows the zone state.

**Output state** – widget shows the output state.

**Temperature** – widget displays temperature. Information about temperature is obtained from an ABAX 2 wireless device.

**Date/time** – widget displays date and time.

**Switch** – widget used to turn on / off an output.

**Rectangle** – widget displays a rectangle on the screen.

**Macro** – widget used to run a macro command.

**PANIC/FIRE/AUX.** – widget used to trigger a panic / fire / medical alarm.

**Information** – widget used to display a message that you entered.

**Link** – widget allows the user to go to additional screen / return to user screen.

**Button** – the widget offers two functions:

tap – the user can tap the widget to turn on / off an output.

tap and hold – the user can tap and hold the widget to turn on an output. The output will remain on as long as the user holds the widget. When the user takes his finger off the widget, the output will be turned off.

**Power measuring** – widget displays information on the power consumption of the appliance connected to the ASW-200 smart plug.

**Thermostat** – widget is used to adjust the temperature settings for the thermostat.

**Add** – click to add the widget selected in the field above. It will be placed on the screen preview.



– click to move the widget up on the list.



– click to move the widget down on the list.

**Delete** – click to delete the selected widget.

**[Screen preview]** – preview shows what the user will see on the keypad screen. Use the “drag and drop” method to move widgets around the screen. Alternatively, you can use the arrow keys to move a selected widget.

### “Text” widget settings

**Position X/Y** – position of the widget on the screen.

**Type** – type of information displayed by the widget. Click  to select:

**Text** – widget displays a text that you entered.

**This keypad name** – widget displays the keypad name.

**Part. name** – widget displays the partition name.

**Zone name** – widget displays the zone name.

**Output name** – widget displays the output name.

**Module name** – widget displays the expansion module name.

**Timer name** – widget displays the timer name.

**Text** – text to be displayed by the widget. This field is available if you selected the “Text” type.

**Part. name** – partition whose name is displayed by the widget. Click  to select a partition. This field is available if you selected the “Part. name” type.

**Zone name** – zone whose name is displayed by the widget. Click  to select a zone. This field is available if you selected the “Zone name” type.

**Output name** – output whose name is displayed by the widget. Click  to select an output. This field is available if you selected the “Output name” type.

**Module name** – module whose name is displayed by the widget. Click  to select a module. This field is available if you selected the “Module name” type.

**Timer name** – timer whose name is displayed by the widget. Click  to select a timer. This field is available if you selected the “Timer name” type.

**Color1** – color of the widget. Click  to select a color.

**Size** – size of the widget on the screen. Select one of three available sizes.

#### “Partition state” widget settings

**Position X/Y** – position of the widget on the screen.

**Partition** – partition whose state is presented by the widget. Click  to select a partition.

**Size** – size of the widget on the screen. Select one of three available sizes.

#### “Zone state” widget settings

**Position X/Y** – position of the widget on the screen.

**Type** – the way the zone state is presented. Click  to select:

**Indicator** – zone state is presented by icons selected by SATEL. The widget will display different states.

**Text** – zone state is presented by text messages. You can enter messages of your choice. The widget will only display normal state and violation.

**Icon** – zone state is presented by icons you choose. The widget will only display normal state and violation.

**Zone** – zone whose state is presented by the widget. Click  to select a zone.

**Normal state** – text / icon displayed when the zone is in normal state. This field is available if you selected the “Text” / “Icon” type.

**Violation** – text / icon displayed when the zone is violated. This field is available if you selected the “Text” / “Icon” type.

**Color1** – color of the widget when zone is in normal state. Click  to select a color.

**Color2** – color of the widget when zone is violated. Click  to select a color.

**Size** – size of the widget on the screen. Select one of three available sizes.

**Alignment** – text alignment. The text can be left-aligned, centered or right-aligned. This parameter is available if you selected the “Text” type.

#### “Output state” widget settings

**Position X/Y** – position of the widget on the screen.

**Type** – the way the output state is presented. Click  to select:

**Indicator** – output state is presented by icons selected by SATEL.

**Text** – output state is presented by text messages. You can enter messages of your choice.

**Icon** – output state is presented by icons you choose.

**Output** – output whose state is presented by the widget. Click  to select an output.

**Off** – text / icon displayed when the output is turned off. This field is available if you selected the “Text” / “Icon” type.

**Active** – text / icon displayed when the output is turned on. This field is available if you selected the “Text” / “Icon” type.

**Color1** – color of the widget when the output is turned off. Click  to select a color.

**Color2** – color of the widget when the output is turned on. Click  to select a color.

**Size** – size of the widget on the screen. Select one of three available sizes.

**Alignment** – text alignment. The text can be left-aligned, centered or right-aligned. This parameter is available if you selected the “Text” type.

### “Temperature” widget settings

**Position X/Y** – position of the widget on the screen.

**Zone** – zone to which the ABAX 2 wireless device providing temperature information is assigned. Click  to select a zone.

**°C** – if you select this option, temperatures will be expressed in degrees Celsius.

**°F** – if you select this option, temperatures will be expressed in degrees Fahrenheit.

**Color1** – color of the widget. Click  to select a color.

**Size** – size of the widget on the screen. Select one of three available sizes.

**Alignment** – text alignment. The text can be left-aligned, centered or right-aligned.

### “Date/time” widget settings

**Position X/Y** – position of the widget on the screen.

**Format** – the way that date and time is displayed. Use the following characters to define the date and time format (the number of letters affects what information is displayed):

**d** – day/date (1 to 6 letters),

**M** – month (1 to 4 letters),

**y** – year (1 to 3 letters),

**s** – seconds (1 to 2 letters),

**m** – minutes (1 to 2 letters),

**h** – hour (1 to 2 letters),

**t** – time (1 to 2 letters),

**c** – date and time.

**Color1** – color of the widget. Click  to select a color.

**Size** – size of the widget on the screen. Select one of three available sizes.

**Alignment** – text alignment. The text can be left-aligned, centered or right-aligned.

### “Switch” widget settings

**Position X/Y** – position of the widget on the screen.

**Control output** – output controlled by the widget. Click  to select an output (select a controllable output).

**Off** – icon displayed when the output is turned off. Click  to select a pictogram.

**Active** – icon displayed when the output is turned on. Click  to select a pictogram.

**Color1** – color of the widget when the output is turned off. Click  to select a color.

**Color2** – color of the widget when the output is turned on. Click  to select a color.

**Size** – size of the widget on the screen. Select one of three available sizes.

### “Rectangle” widget settings

**Position X/Y** – position of the widget on the screen.

**Transparency** – scale to determine the degree of transparency of the rectangle.

**Color** – fill color of the rectangle. Click  to select a color.

**Frame color** – color of the frame around the rectangle. Click  to select a color.

**Thickness** – thickness of the frame around the rectangle.

**Size W/H** – rectangle size in pixels (width / height).

### “Macro” widget settings

**Position X/Y** – position of the widget on the screen.

**Macro** – macro command run by the widget. Click  to select a macro command (you need to create the macro command first – see “Macro Commands” p. 46).

**Authorization required** – if this option is enabled, the macro command is executed only after the user enters the code.

**Disabl. if armed** – if this option is enabled, the macro command is not available if any of the partitions supported by the keypad is armed.

**Hold-down** – if this option is enabled, the user is to tap and hold the widget for 3 seconds to run the macro command.

**Log out after execution** – if the option is enabled, the user will be logged out after executing the macro command (even if the control panel fails to perform the functions assigned to the macro command). If the option is disabled, after executing a macro command that required the user to enter a code, the user will be logged in.

**State** – information about the “State” parameter setting in the “Macro Commands” window.

**Zone** – information about the “Zone” parameter setting in the “Macro Commands” window.

**Output** – information about the “Output” parameter setting in the “Macro Commands” window.

**Normal / Inactive** – pictogram selected for the macro command in the “Macro Commands” window (fields “Icon” or “Off”). You can select its color in the field below.

**Active** – pictogram selected for the macro command in the “Macro Commands” window (field “Active”). You can select its color in the field below.

**Size** – size of the widget on the screen. Select one of three available sizes.

### “PANIC/FIRE/AUX.” widget settings

**Position X/Y** – position of the widget on the screen.

**Type** – type of alarm that will be triggered when the widget is run (“PANIC alarm” / “FIRE alarm” / “MEDICAL alarm”). Click  to select a type.

**Color1** – color of the widget. Click  to select a color.

**Size** – size of the widget on the screen. Select one of three available sizes.

### “Information” widget settings

**Position X/Y** – position of the widget on the screen.

**Message** – message that will be displayed when the widget is run.

**Size** – size of the widget on the screen. Select one of three available sizes.

### “Link” widget settings

**Position X/Y** – position of the widget on the screen.

**Link** – response to tapping on the widget. Click  to select:

**Return** – user screen will be displayed.

**[name of additional screen]** – selected additional screen will be displayed.

**New additional screen** – click to add an additional screen.

**Icon** – pictogram used to display the link on the screen. Click  to select a pictogram.

**Color1** – color of the widget when inactive. Click  to select a color.

**Color2** – color of the widget when active. Click  to select a color.

**Size** – size of the widget on the screen. Select one of three available sizes.

### “Button” widget settings

**Position X/Y** – position of the widget on the screen.

**Control output** – output controlled by the widget. Click  to select an output (select “15. Controlled” type output).

**Off** – icon displayed when the output is turned off. Click  to select a pictogram.

**Active** – icon displayed when the output is turned on. Click  to select a pictogram.

**Color1** – color of the widget when the output is turned off. Click  to select a color.

**Color2** – color of the widget when the output is turned on. Click  to select a color.

**Size** – size of the widget on the screen. Select one of three available sizes.

### “Power measuring” widget settings

**Position X/Y** – position of the widget on the screen.

**Output** – output to which the ASW-200 smart plug is assigned. The widget displays information on the power consumption of the appliance connected to the ASW-200 smart plug. Click  to select an output.

**Text** – value details (e.g. power unit). It is displayed after the value (on the right).

**Color1** – color of the widget. Click  to select a color.

**Size** – size of the widget on the screen. Select one of three available sizes.

**Alignment** – text alignment. The text can be left-aligned, centered or right-aligned.

### “Thermostat” widget settings

**Position X/Y** – position of the widget on the screen.

**Thermostat output** – thermostat whose settings can be adjusted when the user taps the widget. Click  to select a thermostat.

**Color1** – color of the widget when the thermostat is turned off. Click  to select a color.

**Color2** – color of the widget when the thermostat is turned on. Click  to select a color.

**Size** – size of the widget on the screen. Select one of three available sizes.

## Macro Commands

A macro command is a sequence of actions to be performed by the control panel. Configure a macro command and add it to the user screen as a widget. This will help the user to operate the alarm system. Instead of performing several operations (e.g. in order to arm selected partitions), the user can tap a widget to run a macro command, and the control panel will execute the functions assigned to the macro command.

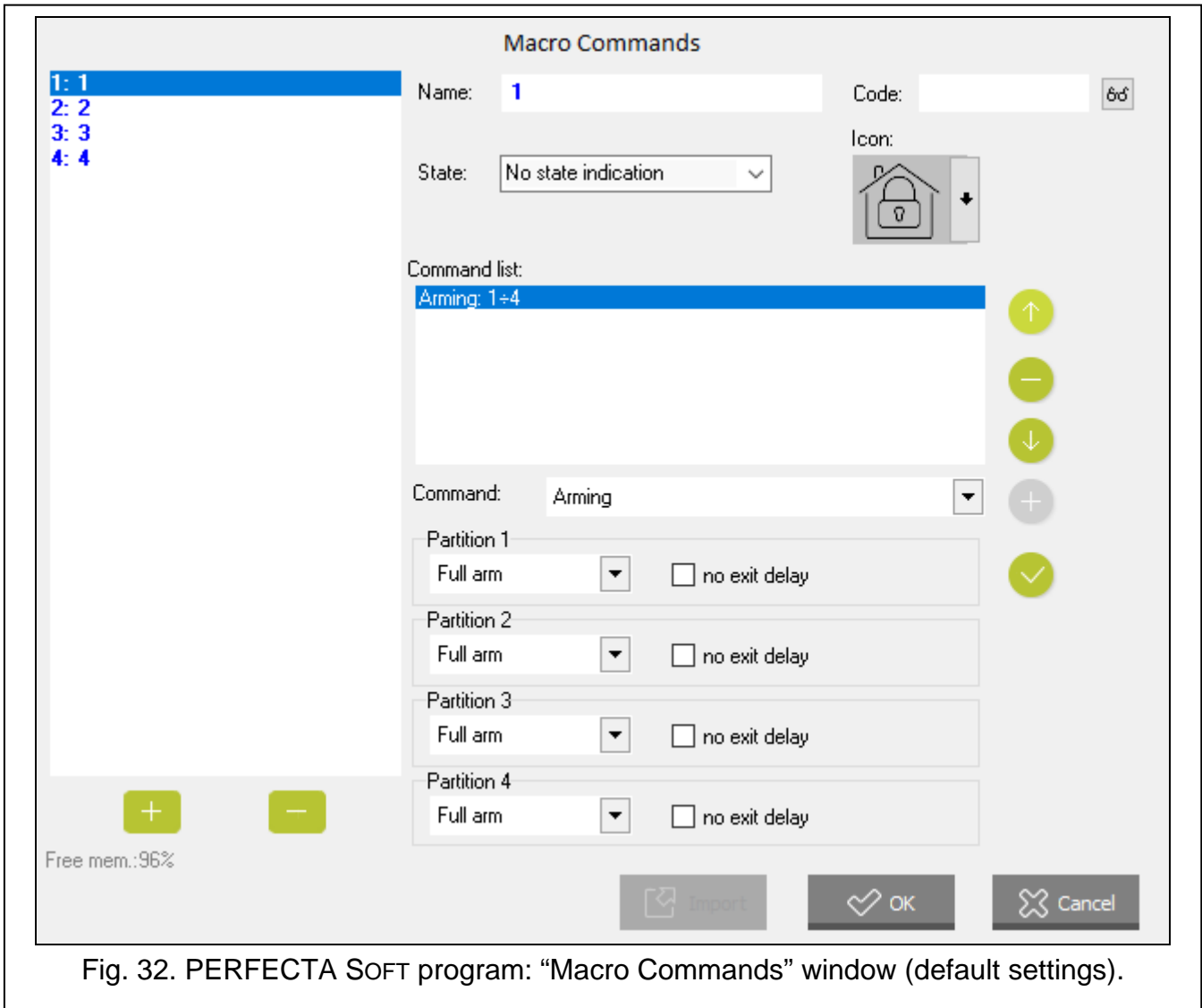





Fig. 32. PERFECTA SOFT program: “Macro Commands” window (default settings).

 – click to create a new macro command.

 – click to delete a selected macro command.

**Name** – individual name of the macro command (up to 16 characters).

**Code** – code sent to the control panel when executing commands contained in the macro command. For execution of such commands to be possible, the code must be granted a suitable authority level. Click  to view the code.

 *If, when executing a macro command, it turns out that the code is invalid (e.g. it has been changed), the user will be asked to enter the correct code. It will be automatically saved to the keypad memory (replacing the invalid one).*

**State** – widget can inform the user by means of icons about the state of selected alarm system elements (e.g. partition armed by a macro command or output controlled by a macro command).

**No state indication** – if you select this option, the widget will not indicate the state (only one icon will be used).

**State follow zone** – if you select this option, the widget will indicate the state based on the zone state (two icons will be used).

**State follow output** – if you select this option, the widget will indicate the state based on the output state (two icons will be used).

**Zone** – widget indicates the state of this zone if you selected the “State follow zone” option. Select the zone whose state will be affected by the macro command (e.g. zone that supervises the operation of a device turned on / off by a macro command).



**Output** – widget indicates the state of this output if you selected the “State follow output” option. Select the output whose state will be affected by the macro command (e.g. the “18: Armed status” type output which turns on after partition is armed).

**Icon** – pictogram used to represent a macro command on the screen. Click  to select a pictogram.

**Off** – pictogram used to represent a macro command on the screen when the widget indicates the inactive state. Click  to select a pictogram.

**Active** – pictogram used to represent a macro command on the screen when the widget indicates the active state. Click  to select a pictogram.

**Commands list** – commands assigned to the currently highlighted macro command.

The  and  buttons allow you to change the order of commands (moving the selected command up and down).

 – click to move the selected command up.

 – click to remove the selected command.

 – click to move the selected command down.

**Command** – function that you can assign to the macro command. Click  to drop down the list of available functions, then click the function that you want to assign to the macro command.

 – click to add to the command list a new one selected in the “Command” field.

 – click to save the changes to the command settings that were made after adding the command to the list (otherwise, the changes will not be saved).

**Partition 1 / Partition 2 / Partition 3 / Partition 4** – function run in the partition in the case of “Arming” command:

**none** – no function,

**Full arm** – arming in full mode,

**Night arm** – arming in night mode,

**Day arm** – arming in day mode.

**no exit delay** – if this option is enabled, the partition will be armed instantly (the exit delay countdown will not run). The option is available for the “Arming” command.

**List** – fields in this table represent the system elements (partitions / zones / outputs) that can be controlled by the function. The numbers of the fields in the table correspond to the numbers of the elements in the system. The color of the field indicates:

orange – function controls this system element,

white – function does not control this system element.

Double-click the field to change its color.

Depending on the selected function:

**Disarming** – select the partitions to be disarmed.

**Alarm clearing** – select the partitions in which alarm is to be cleared.

**Bypass zones** – select the zones which are to be inhibited.

**Unbypass zones** – select the zones which are to be unbypassed.

**Outputs ON** – select the outputs which are to be activated.

**Outputs OFF** – select the outputs which are to be deactivated.

**Change outputs state** – select the outputs whose state is to be changed.



*The zones must not have the “Bypass disabled” option enabled.*



*The outputs must be the “15: Controlled” type.*



**Import** – click to import macro commands settings from another keypad.

**OK** – click to confirm the changes and close the window.

**Cancel** – click to close the window without saving changes.

### Creating a macro command

1. Click the “Read” button in the “Screen” tab to read the macro command settings from the keypad.
2. Click the “Macro Commands” button. The “Macro Commands” window will open.
3. Click . A new macro command will appear in the list.
4. Enter a name for the new macro command.
5. If the user is to run the macro command without entering the code, enter the code. You can create an additional user whose code will be used for this purpose. The user must be granted a suitable authority level in order to be able to run the functions that you want to assign to the macro command.
6. Specify if the widget displayed in the keypad is to show the state:
  - select the “No state indication” option if the widget is not to show the state,
  - select the “State follow zone” or “State follow output” option if the widget is to show the state.
7. If you selected the “State follow zone” / “State follow output” option, select the zone / output whose state is to control the widget icons.
8. Select the icon (if you select the “No state indication” option) / icons (if you selected the “State follow zone” / “State follow output” option) that will be used to display the macro command on the screen.
9. Click  in the “Command” field and select from the list the function that will be executed by the new macro command.
10. Configure the command parameters (e.g. select the partitions to be disarmed).

11. Click  next to the “Command” field. A new command will appear in the list of commands assigned to the macro command. After clicking on the command, you can change its settings (after making changes, click ).
12. Repeat the steps 9-11 if you want the macro command to execute more functions.
13. Click the “OK” button to confirm changes. The “Macro Commands” window will close.
14. Click the “Write” button to write the macro command settings to the keypad.



*The user will be able to use the macro command if you add it to the user screen as a widget.*

### **Save to SD card**

In the window you can prepare additional images to be saved on the memory card.

**Save to SD card** – click to save the prepared image files to the memory card.

### Images/backgrounds

The tab displays the background images you added from a file while creating screens in the “Screen” tab. This tab is available if any of the screens uses a background image added by you from a file.



Fig. 33. PERFECTA SOFT program: “Images/backgrounds” tab in the “Save to SD card” window (example).

**Show SD card content** – if the option is enabled, background images already saved on the SD card are displayed in the tab (after enabling the option, indicate the path to the SD card).

### Slideshow

In the tab, you can prepare a set of images for a slideshow in the keypad.

**Add** – click to add a new image to the slideshow.

**Delete** – click to delete a selected image from the slideshow.

**Clear** – click to delete all images.

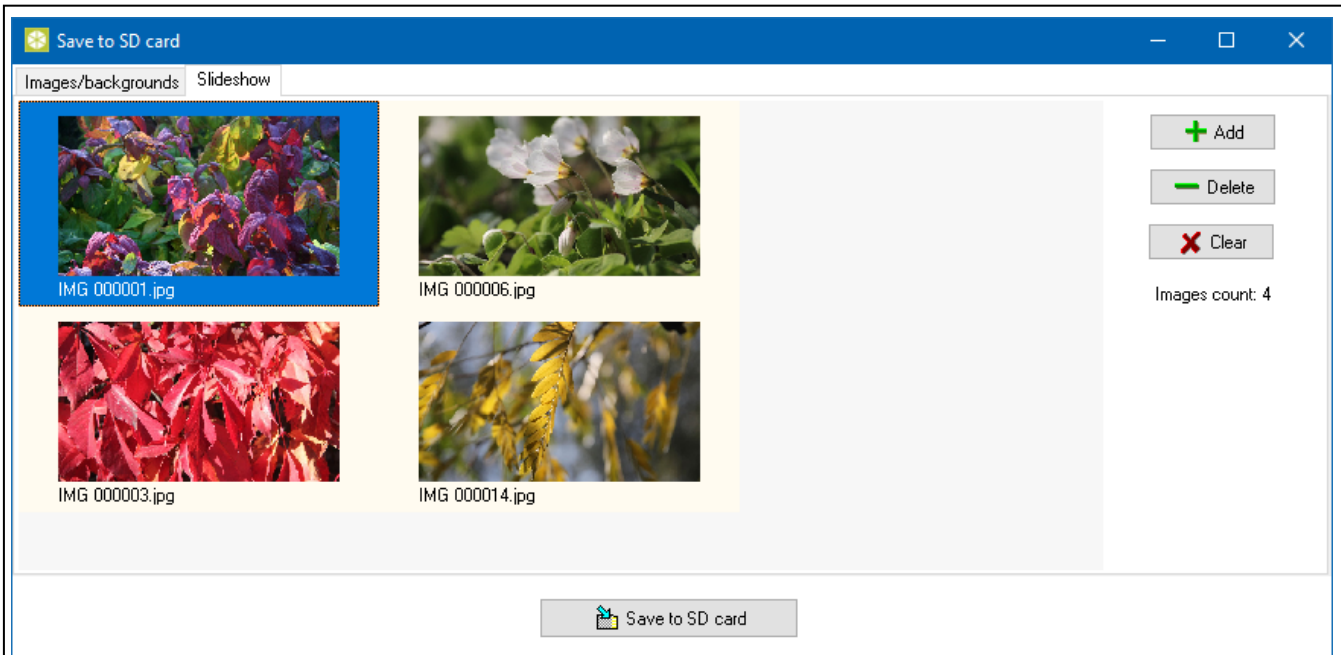



Fig. 34. PERFECTA SOFT program: “Slideshow” tab in the “Save to SD card” window (example).

## 6.3 Keypad in the VERSA system







You can configure all the keypad settings from the computer with the DLOADX program installed. Using the keypad, you can configure only some of the settings. Names of parameters and options from the DLOADX program are used in this manual.

### 6.3.1 Programming with the DLOADX program

Required version of the DLOADX program: 1.21.001 (or newer).

1. Click  in the main menu. The “Structure” window will be displayed.
2. Click the “Hardware” tab.
3. Click the “Keypad” branch.
4. Click the name of the keypad whose settings you want to configure.
5. Configure the keypad settings.
6. Click  in the main menu to save changes to the control panel. For settings stored in the keypad (“Keypad data” tab), click the “Write” button.

### 6.3.2 Programming from the keypad

1. Start the service mode (see “Starting the service mode in the VERSA system” p. 12).
2. Tap    . The “2.Settings” function will start.
3. Find the keypad whose settings you want to configure (use  or  key) and tap .
4. Configure the keypad settings using the available functions.

### 6.3.3 Keypad settings

Shown in square brackets are the names of parameters and options displayed in the keypad.

#### INT-TSG2

**Name** – individual name of the keypad (up to 16 characters).

**Tamper signaled in part.** [Tamper in part.] – partition where tamper alarm will be triggered in the event of opening the keypad tamper switch or keypad absence.

**CHIME signal of zones** [Zone chime] – the keypad can audibly signal violation of selected zones. If the zone is armed, violation will not trigger the CHIME signal.

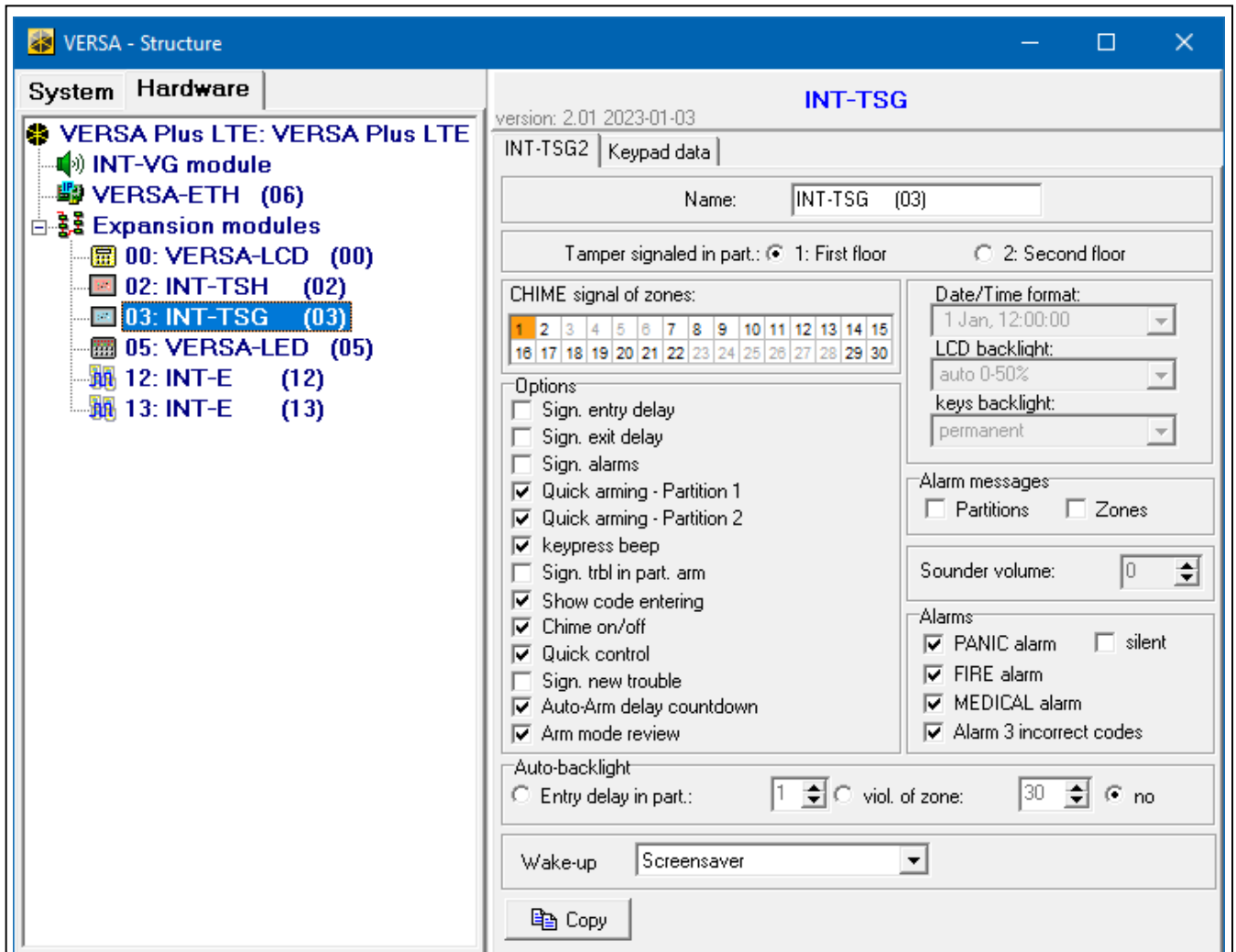

Fig. 35. DLOADX program: keypad in the VERSA system – “INT-TSG2” tab (example).

#### Options

**Sign. entry delay** [Entry time sign.] – if this option is enabled, the keypad will audibly signal the entry delay countdown.

**Sign. exit delay** [Exit time sign.] – if this option is enabled, the keypad will audibly signal the exit delay countdown.

**Sign. alarms** – if this option is enabled, the keypad will signal the alarms audibly.

**Quick arming – Partition 1** – if this option is enabled, the user can arm partition 1 from the keypad without using code.

**Quick arming – Partition 2** – if this option is enabled, the user can arm partition 2 from the keypad without using code.

**Keypress beep** [Key sounds] – if this option is enabled, tapping the screen is confirmed by a sound.

**Sign. trbl in part. arm** [Trbl.in part.arm] – if this option is enabled, the  LED goes off after both partitions are fully armed (if the option is disabled, the LED goes off after just one of the partitions is armed in any mode).

**Show code entering** [Code entry ind.] – if this option is enabled, entering the code is presented on the keypad display by asterisks.

**Chime on/off** – if this option is enabled, the user can turn on / off the CHIME signal by tapping and holding the  key of the terminal for 3 seconds.

**Quick control** – if this option is enabled, the user can control the outputs without entering the code:

- using widgets,
- using the number keys on terminal. The “15. Controlled” type outputs should be assigned to keys (see the control panel programming manual).

**Sign. new trouble** – if this option is enabled, the keypad will audibly signal the occurrence of any new trouble (additionally, the “Trouble memory until review” option must be enabled in the control panel – see: control panel programming manual). The signaling will be turned off after reviewing the trouble with the “7. System state” user function.

**Auto-Arm delay countdown** [Autoarm signal.] – if this option is enabled, the auto-arm delay countdown is signaled acoustically.

**Arm mode review** [Arm mode check.] – if this option is enabled, the user can tap and hold the  key of the terminal for 3 seconds to display information about the partition state. This function is not available when the “Grade 2” option is enabled.

## Alarm messages

**Partitions** [Part.alarm msg.] – if this option is enabled, messages on partition alarms will be displayed (they contain the name of partition).

**Zones** [Zone alarm msg.] – if this option is enabled, messages on alarms from zones will be displayed (they contain the name of zone). The zone alarm messages have the priority.

## Alarms

**PANIC alarm** – if this option is enabled, the user can trigger a panic alarm from the keypad by using a widget, from the terminal (by tapping and holding the  key for 3 seconds) or by tapping and holding the screen for 3 seconds when the screensaver or the slideshow is displayed.

**silent** [Silent panic] – if this option is enabled, the panic alarm triggered from the keypad will be a silent one, i.e. the keypad will not indicate it, there will be no audible signal, but the alarm will be reported to the monitoring station. The silent panic alarm is useful when the control panel is sending events to the monitoring station, but unauthorized persons should not be aware of the alarm being triggered. This option is available when the “PANIC alarm” option is enabled.

**FIRE alarm** – if this option is enabled, the user can trigger a fire alarm from the keypad by using a widget or from the terminal (by tapping and holding the  key for 3 seconds).

**MEDICAL alarm** – if this option is enabled, the user can trigger a medical alarm from the keypad by using a widget or from the terminal (by tapping and holding the  key for 3 seconds).

**Alarm 3 incorrect codes** – if this option is enabled, entering incorrect code three times will trigger the alarm.

### **Auto-backlight**

**Entry delay in part.** – if you select this option, the keypad will be woken up when the entry delay countdown begins in a selected partition.

**viol. of zone** – if you select this option, the keypad will be woken up when a selected zone is violated.

**no** – if you select this option, the keypad will be woken up only when the user taps the screen.

**Wake-up** – the way the keypad will respond to the wake-up (after a tap on the screen by the user or occurrence of a specified event in the system):

**Screensaver** – screensaver will be displayed.

**User screen** – user home screen will be displayed.



*If you disable the screensaver (see option “No screensaver” p. 25), the user home screen will always be displayed after wake-up.*

### **Keypad data**

In the tab, you can configure the settings stored in the keypad. You can only configure them in the DLOADX program.

The buttons located on the bottom of the window apply to all settings that are stored in the keypad.

**Read** – click to read data from the keypad.

**Write** – click to write data to the keypad.



**Quit** – click to cancel the reading / writing of data.

**Reset** – click to restore the factory default settings of the keypad (this command applies to the settings presented in the “Keypad data” tab).

**Export to file** – click to export the keypad data to a file.

**Import from file** – click to import the keypad data from a file.



*Before you make any changes, click the “Read” button, and after you make the changes, click the “Write” button. The settings stored in the keypad are not read / written after you click  /  in the main menu.*

### **Macro Commands**

A macro command is a sequence of actions to be performed by the control panel. Configure a macro command and add it to the user screen as a widget. This will help the user to operate the alarm system. Instead of performing several operations (e.g. in order to arm selected partitions in different modes), the user can tap a widget to run a macro command, and the control panel will execute the functions assigned to the macro command.

**New macro** – click to create a new macro command.

**Remove macro** – click to delete a selected macro command.

**Name** – individual name of the macro command (up to 16 characters).

**Code** – code sent to the control panel when executing commands contained in the macro command. For execution of such commands to be possible, the code must be granted a suitable authority level. Click  to view the code.

**i** *If, when executing a macro command, it turns out that the code is invalid (e.g. it has been changed), the user will be asked to enter the correct code. It will be automatically saved to the keypad memory (replacing the invalid one).*

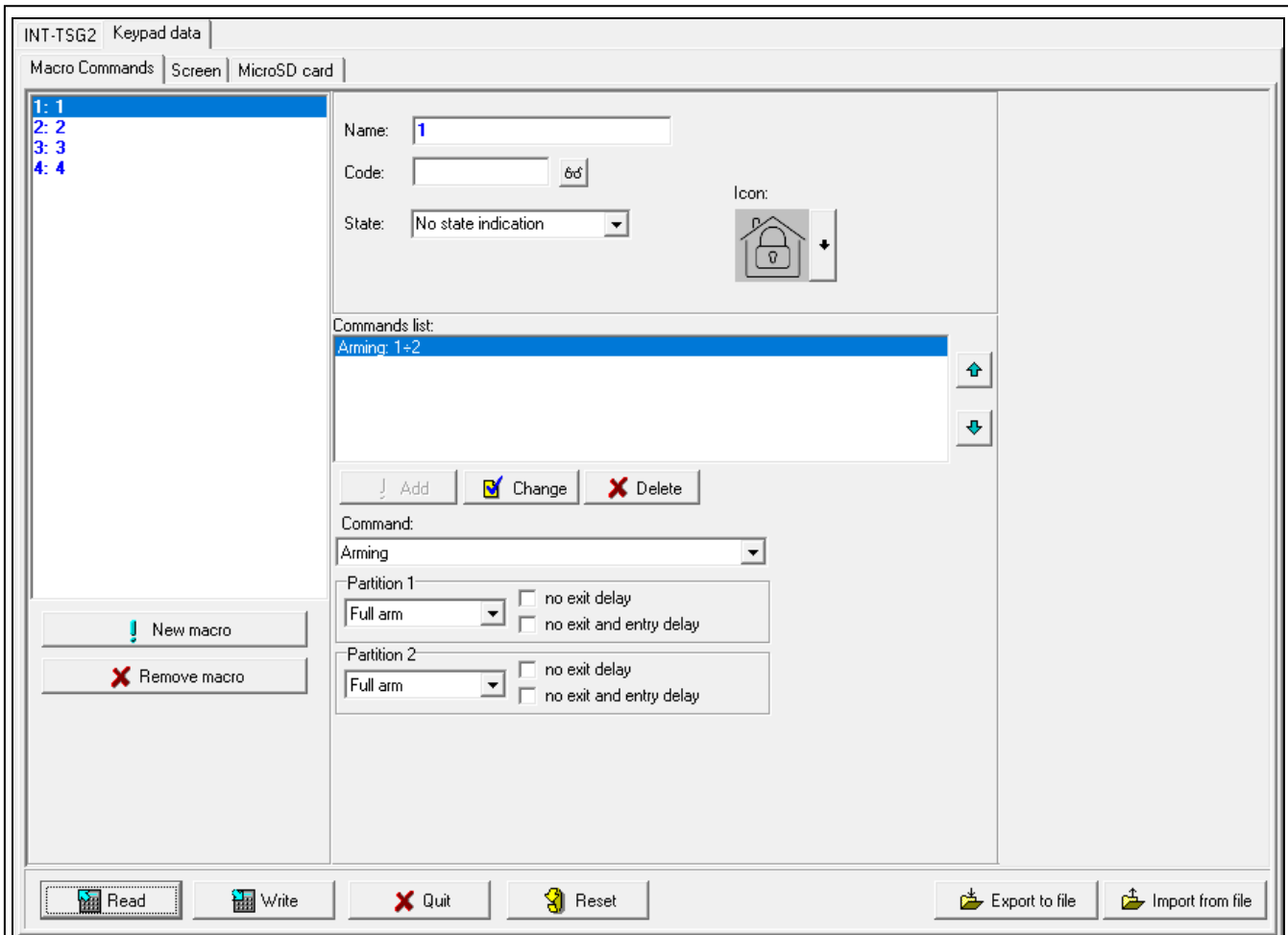

Fig. 36. DLOADX program: keypad in the VERSA system – “Macro Commands” tab (default settings).

**State** – widget can inform the user by means of icons about the state of selected alarm system elements (e.g. partition armed by a macro command or output controlled by using a macro command).

**No state indication** – if you select this option, the widget will not indicate the state (only one icon will be used).

**State follow input** – if you select this option, the widget will indicate the state based on the zone state (two icons will be used).

**State follow output** – if you select this option, the widget will indicate the state based on the output state (two icons will be used).



**Zone** – widget indicates the state of this zone if you selected the “State follow input” option. Select the zone whose state will be affected by the macro command (e.g. zone that supervises the operation of a device turned on / off by a macro command).

**Output** – widget indicates the state of this output if you selected the “State follow output” option. Select the output whose state will be affected by the macro command (e.g. the “18: Armed status” type output which turns on after partition is armed).

**Icon** – pictogram used to represent a macro command on the screen. Click  to select a pictogram.

**Off** – pictogram used to represent a macro command on the screen when the widget indicates the inactive state. Click  to select a pictogram.

**Active** – pictogram used to represent a macro command on the screen when the widget indicates the active state. Click  to select a pictogram.

**Commands list** – commands assigned to the currently highlighted macro command. The  and  buttons allow you to change the order of commands (moving the selected command up and down).

**Add** – click to add to the list a new command selected in the “Command” field.

**Change** – click to save the changes to the command settings that were made after adding the command to the list (otherwise, the changes will not be saved).

**Delete** – click to remove the highlighted command from the list.

**Command** – function that you can assign to the macro command. Click  to drop down the list of available functions, then click the function that you want to assign to the macro command.

**Partition 1 / Partition 2** – function run in the partition if the “Arming” command is selected:

**none** – no function,

**Full arm** – arming in full mode,

**Night arm** – arming in night mode,

**Day arm** – arming in day mode.

**no exit delay** – if this option is enabled, the partition will be armed instantly (the exit delay countdown will not run).

**no exit and entry delay** – if this option is enabled, the partition will be armed instantly (the exit delay countdown will not run) and the delayed zones will act as instant (without any entry delay time).

**List** – fields in this table represent the system elements (partitions / zones / outputs) that can be controlled by the function. The numbers of the fields in the table correspond to the numbers of the elements in the system. The color of the field indicates:

orange – function controls this system element,

white – function does not control this system element.

Double-click the field to change its color.

Depending on the selected function:

**Disarming** – select the partitions to be disarmed.

**Alarm clearing** – select the partitions in which alarm is to be cleared.

**Bypass zones** – select the zones which are to be inhibited.

**Unbypass zones** – select the zones which are to be unbypassed.

**Outputs ON** – select the outputs which are to be activated.

**Outputs OFF** – select the outputs which are to be deactivated.

**Change outputs state** – select the outputs whose state is to be changed.



*The zones must not have the “Bypass disabled” option enabled.*

*The outputs must be the “15: Controlled” type.*

### **Creating a macro command**

Create a macro command in the same way as in the keypad in the INTEGRA system (see p. 23).

### **Screen**

In the tab, you can prepare screens that will be used by the user for day to day operation of the alarm system from the keypad. Do it in the same way as in the keypad in the INTEGRA system (see p. 24 and the following).



*The “Temperature” and “Thermostat” widgets are not available in the VERSA alarm system.*

### **MicroSD card**

In the tab you can prepare additional images to be saved on the memory card. Do it in the same way as in the keypad in the INTEGRA system (see p. 32 and the following).

## **7. Updating the keypad firmware**

---



*The keypad cannot be used during the firmware update.*

*Start the service mode before you open the keypad enclosure to remove / insert the memory card (see “Starting the service mode in the INTEGRA system” p. 7 / “Starting the service mode in the PERFECTA 64 M system” s. 9 / “Starting the service mode in the VERSA system” p. 12). The alarm system must be in the service mode during the firmware update.*

1. Download the new keypad firmware version from [www.satel.pl](http://www.satel.pl).
2. Save the new firmware version to the memory card.
3. Open the keypad enclosure and insert the card into the slot.
4. Use the function or restart the keypad to update the firmware.

### **7.1 Update using the function**

---

#### **7.1.1 Keypad in the INTEGRA system**

1. Run the “Hide SM now” function (▶”SM settings” ▶”Hide SM now”). Depending on the “No screensaver” option setting (see: p. 25):
  - option disabled: screensaver will be displayed – go to point 2,
  - option enabled: user screen will be displayed – go to point 3.
2. Tap the keypad screen. The user screen will be displayed.
3. Swipe the screen up. The on-screen keypad will be displayed.
4. Enter the service code and tap . The user menu home screen will be displayed.
5. Tap the “Settings” function. The “Settings” screen will be displayed (Fig. 37).

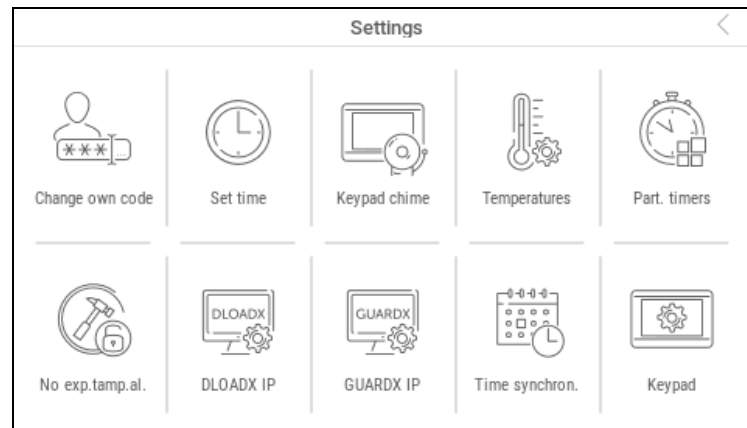

Fig. 37. "Settings" screen (example).

6. Tap the "Keypad" function. The "Keypad" screen will be displayed (Fig. 38).

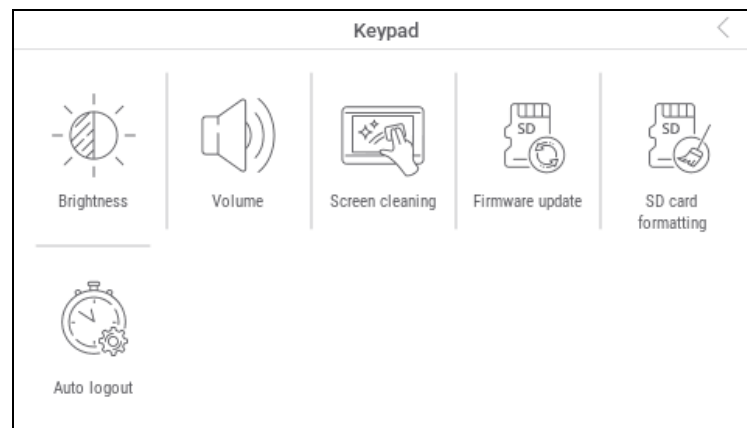







Fig. 38. "Keypad" screen.

7. Tap the "Firmware update" function. Two buttons will be displayed on the bottom of the screen.

8. Tap the  button. The keypad will restart and the firmware update will begin.

### 7.1.2 Keypad in the PERFECTA 64 M system

1. Tap   . The "09.Hide SM" function will start. The service menu will be hidden.

2. Tap  to the right of the terminal to close the terminal. The user menu home screen will be displayed.



3. Tap the "Keypad" function. The "Keypad" screen will be displayed (Fig. 38).

4. Tap the "Firmware update" function. Two buttons will be displayed on the bottom of the screen.

5. Tap the  button. The keypad will restart and the firmware update will begin.

### 7.1.3 Keypad in the VERSA system

1. Run the "A. Hide SM now" function (▶"0. SrvMod config" ▶"A. Hide SM now"). The menu will be hidden.

2. Tap  to the right of the terminal to close the terminal. The user menu home screen will be displayed.
3. Tap the “Keypad” function. The “Keypad” screen will be displayed (Fig. 38).
4. Tap the “Firmware update” function. Two buttons will be displayed on the bottom of the screen.
5. Tap the  button. The keypad will restart and the firmware update will begin.

## 7.2 Update after restart

---

1. Disconnect the keypad from the power supply.
2. Connect the keypad to the power supply. The keypad will start up and the firmware update will begin.

## 8. Specifications

---

Supply voltage .....	12 VDC ±15%
Standby current consumption .....	100 mA
Maximum current consumption .....	140 mA
Supported memory cards.....	microSD, micro SDHC
Security grade according to EN 50131 .....	Grade 3
Environmental class according to EN 50130-5 .....	II
Working temperature range .....	-10°C...+55°C
Maximum humidity .....	93±3%
Enclosure dimensions (width x height x thickness) .....	120 x 92 x 14 mm
Weight.....	160 g

## 9. Manual update history

---

Manual version	Introduced changes
12/21	<ul style="list-style-type: none"> <li>• Section “Address setting” has been updated (p. 7).</li> </ul>
01/23	<ul style="list-style-type: none"> <li>• Information on the required firmware version of the INTEGRA series control panels has been updated (p. 3).</li> <li>• Description of how to connect detectors to the keypad zones has been modified (p. 6).</li> <li>• Section “Preparing the image files” has been added (p. 16).</li> <li>• Information on the required DLOADX program version for the keypad in the INTEGRA system has been added (p. 17).</li> <li>• Note on the keypad wake-up in the INTEGRA system has been added (p. 20).</li> <li>• Description of the “No screensaver” option has been added (p. 25).</li> <li>• Description of the “No clock” option has been added (p. 25).</li> <li>• Description of the “Button” widget has been added (p. 28).</li> <li>• Description of the “Analog value” widget has been added (p. 28).</li> <li>• Description of the “Thermostat” widget has been added (p. 28).</li> <li>• Description of the “Button” widget settings has been added (p. 31).</li> <li>• Description of the “Analog value” widget settings has been added (p. 32).</li> <li>• Description of the “Thermostat” widget settings has been added (p. 32).</li> <li>• Information on the required DLOADX program version for the keypad in the VERSA system has been added (p. 50).</li> </ul>

	<ul style="list-style-type: none"><li>• Note on the keypad wake-up in the VERSA system has been added (p. 53).</li><li>• Information on widgets unavailable in the VERSA system has been modified (p. 56).</li><li>• Description of how to update the keypad firmware using the keypad in the INTEGRA system has been modified (p. 56).</li></ul>
03/23	<ul style="list-style-type: none"><li>• Information on work in the PERFECTA 64 M system has been added.</li><li>• Description of the service mode starting in the PERFECTA 64 M system has been added (p. 9).</li><li>• Description of the address setting in the PERFECTA 64 M system has been added (p. 11).</li><li>• Description of the keypad identification in the PERFECTA 64 M system has been added (p. 14).</li><li>• Description of the keypad programming in the INTEGRA system using the DLOADX program has been modified (p. 17).</li><li>• Description of the keypad programming in the INTEGRA system using the keypad program has been modified (p. 17).</li><li>• Description of the "Button" widget has been added (p. 28).</li><li>• Description of the "Log out after execution" option has been added (p. 31).</li><li>• Description of the "Show SD card content" option has been added (p. 32).</li><li>• Description of the keypad programming in the PERFECTA 64 M system has been added (p. 34).</li><li>• Description of the keypad programming in the VERSA system using the DLOADX program has been modified (p. 50).</li><li>• Description of the keypad programming in the VERSA system using the keypad program has been modified (p. 50).</li><li>• Description of how to update the keypad firmware in the PERFECTA 64 M system has been added (p. 57).</li></ul>