

## Roger Access Control System

# MCT86M-IO-CH-HR Installation Manual

Firmware version: 1.1.30.266 and newer

Document version: Rev.E



This document contains minimum information that is necessary for initial setup and installation of the device. The detailed description of configuration parameters and functionalities is specified in respective Operating Manual available at [www.roger.pl](http://www.roger.pl).

### INTRODUCTION

The reader is designed for operation with MC16 access controller (RACS 5 system) mainly as hotel automation device. Factory new reader is configured with default settings including ID=100 address.

### DEVICE CONFIGURATION

The reader can be configured in regard of various parameters (including address) in order to adapt it to the requirements of specific installation. Device can be configured from VISO v2 management software or RogerVDM utility software.

**Note:** Remote configuration of device from VISO v2 software is possible only if jumper is placed on MEM contacts (fig. 4). If the jumper is removed then such configuration is blocked. In case of factory new device, jumper is placed on MEM contacts.

### CONFIGURATION WITH VISO V2 PROGRAM

In RACS 5 v2 system the reader can be installed at site without previous configuration. According to AN006 application note, its address and other settings can be configured from VISO v2 management software and during such configuration the access to its service contacts (fig. 4) is not required.

### CONFIGURATION WITH ROGERVDM PROGRAM

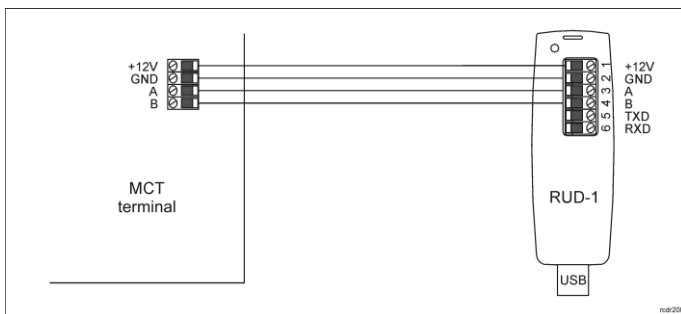

Fig. 1 Connection of MCT device to RUD-1 interface (configuration)

#### Programming procedure:

1. Connect the device to RUD-1 interface (fig. 1) and connect the RUD-1 to computer's USB port.
2. Remove jumper from MEM contacts (fig. 4) if it is placed there.
3. Restart the device (switch power supply off and on or short RST contacts for a moment) and orange LED SYSTEM will pulsate. Then within 5 seconds place jumper on MEM contacts.
4. Start RogerVDM program, select *MCT* device, firmware version, *RS485* communication channel and serial port with RUD-1 interface.
5. Click *Connect*, the program will establish connection and will automatically display *Configuration* tab.
6. Enter unoccupied RS485 address in range of 100-115 and other settings according to requirements of specific installation.
7. Click *Send to Device* to update the configuration of device.
8. Optionally make a backup by clicking *Send to File...* and saving settings to file on disk.
9. Disconnect from RUD-1 interface and leave jumper on MEM contacts to enable further configuration of device from VISO v2 software or remove jumper from MEM contacts to block such remote configuration.

**Note:** Do not read any cards when reader is configured with RogerVDM.

### MANUAL ADDRESSING

Manual addressing procedure enables configuration of new RS485 address with all other settings unchanged.

#### Manual addressing procedure:

1. Remove all connections from A and B lines.
2. Remove jumper from MEM contacts (fig. 4) if it is placed there.
3. Restart the device (switch power supply off and on or short RST contacts for a moment) and orange LED SYSTEM will pulsate. Then within 5 seconds place jumper on MEM contacts.

4. Enter 3 digits of RS485 address in range of 100-115 with any MIFARE card.
5. Leave jumper on MEM contacts to enable further configuration of device from VISO v2 software or remove jumper from MEM contacts to block such remote configuration.
6. Restart the device.

Terminals without keypad can be addressed with multiple card readings where the N number of readings emulates digit of the address. Three series of readings with any MIFARE proximity card are necessary to set the address. After each series wait for two beeps and proceed with the next digit. Zero digit is emulated with 10 readings.

#### Example:

Programming of ID=101 address with card readings:

1. Read card 1 time and wait for two beeps.
2. Read card 10 times and wait for two beeps.
3. Read card 1 time and wait for two beeps.
4. Wait till reader is restarted with the new address.

### MEMORY RESET

Memory reset procedure resets all settings to factory default ones including ID=100 address.

#### Memory reset procedure:

1. Remove all connections from A and B lines.
2. Remove jumper from MEM contacts (fig. 4) if it is placed there.
3. Restart the device (switch power supply off and on or short RST contacts for a moment) and orange LED SYSTEM will pulsate. Then within 5 seconds place jumper on MEM contacts.
4. Read any MIFARE card 11 times.
5. Wait till device confirms reset with long acoustic signal.
6. Leave jumper on MEM contacts to enable further configuration of device from VISO v2 software or remove jumper from MEM contacts to block such remote configuration.
7. Restart the device.

### FIRMWARE UPDATE

The firmware of device can be changed to newer or older version. The update requires connection to computer with RUD-1 interface (fig. 2) and starting RogerVDM software. The latest firmware file is available at [www.roger.pl](http://www.roger.pl).

#### Firmware update procedure:

1. Connect the device to RUD-1 interface (fig. 1) and connect the RUD-1 to computer's USB port.
2. Place jumper on FDM contacts (fig. 4).
3. Restart the device (switch power supply off and on or short RST contacts for a moment).
4. Start RogerVDM program and in the top menu select *Tools* and then *Update firmware*.
5. In the opened window select device type, serial port with RUD-1 interface, path to main firmware file (\*.hex) and additional firmware file (\*.cyacd).
6. Click *Update* to start firmware upload with progress bar in the bottom.
7. When the update is finished, remove jumper from FDM contacts and restart the device.

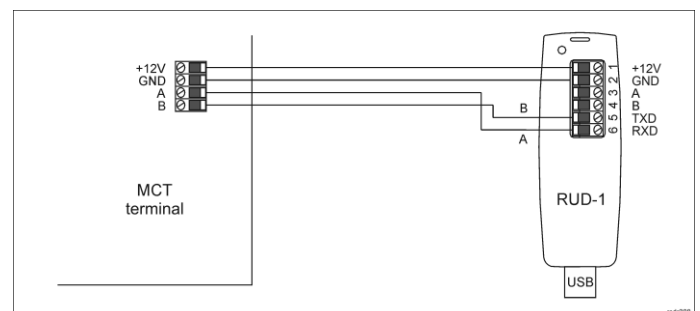

Fig. 2 Connection of MCT device to RUD-1 interface (firmware update)

**APPENDIX**

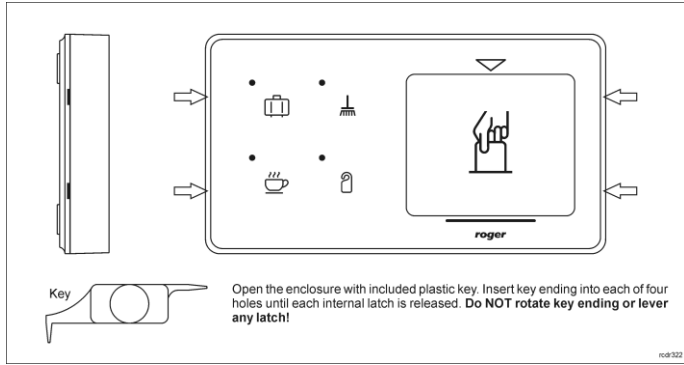

Fig. 3 Enclosure opening

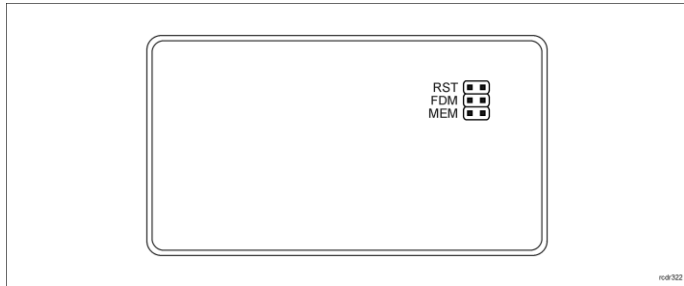

Fig. 4 Service contacts

Table 1. Screw terminals	
Name	Description
12V	Supply plus
GND	Ground
A	RS485 bus, line A
B	RS485 bus, line B
IN1	IN1 input line
IN2	IN2 input line
IN3	IN3 input line
IO1	IO1 output line
IO2	IO2 output line
NC	REL1 relay output (NC)
COM	REL1 relay common terminal
NO	REL1 relay output (NO)

Table 2. Specification	
Supply voltage	Nominal 12VDC, min./max. range 10-15VDC
Current consumption (average)	~60 mA
Inputs	Three parametric inputs (IN1..IN3) internally connected to the power supply plus through a 5.6kΩ resistor. Approx. 3.5V triggering level for NO and NC inputs.
Relay output	Relay output (REL1) with single NO/NC contact, 30V/1A DC/AC max. load
Transistor outputs	Two (IO1, IO2) open collector outputs, 15VDC/150mA max. load
Tamper protection	Enclosure opening reported to access controller
Proximity cards	13.56MHz MIFARE Ultralight, Classic, DESFire (EV1, EV2, EV3) and Plus
Reading range	Up to 7 cm for MIFARE Ultralight, Classic Up to 4 cm for MIFARE DESFire (EV1, EV2, EV3), Plus
Distance	1200m maximal cable length for RS485 bus between controller and terminal
IP Code	IP30
Environmental class (according to EN 50133-1)	Class II, indoor general conditions, temperature: -10°C to +50°C, relative humidity: 10 to 95% (no condensation)
Dimensions H x W x D	155 x 85 x 22 mm
Weight	~180g
Certificates	CE, RoHS

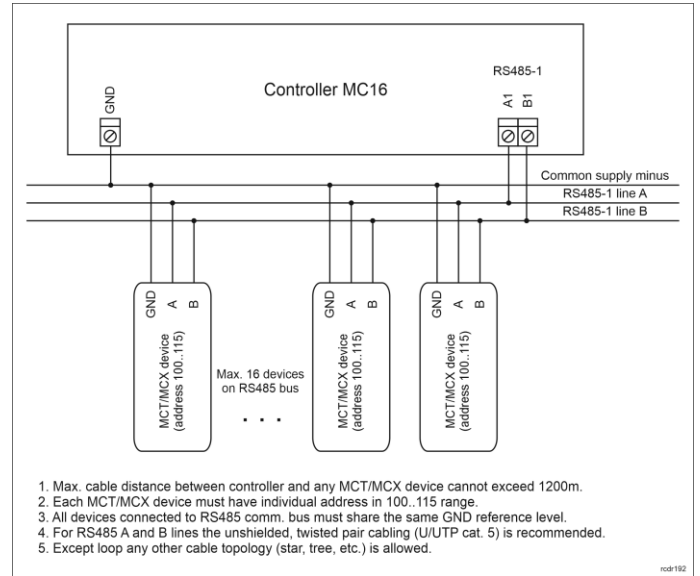

Fig. 5 Connection of terminals and expanders to MC16 access controller

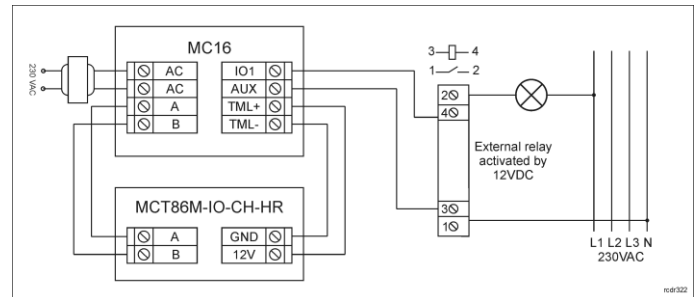
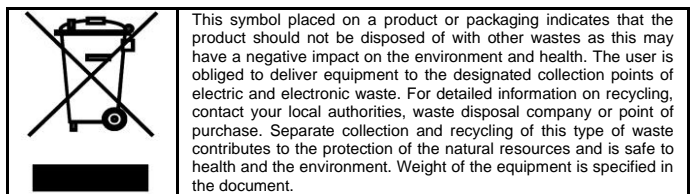

Fig. 6 Typical control of 230VAC supply by terminal with card holder

**INSTALLATION GUIDELINES**

- The terminal should be mounted on a vertical structure (wall) away from sources of heat and moisture.
- In particular, it is not allowed to install the reader in places with high humidity such as saunas, swimming pools, car washes, etc.
- Front panel should be attached in such way as the tamper detector would firmly press the back panel.
- All electrical connections should be done with disconnected power supply.
- If the terminal and controller are not supplied from the same PSU, then GND terminals of both devices must be connected with any wire.
- Device can be cleaned by means of wet cloth and mild detergent without abrasive components. In particular do not clean with alcohols, solvents, petrol, disinfectants, acids, rust removers, etc. Damages resulting from improper maintenance and usage are not covered by manufacturer warranty.



**Contact:**  
 Roger Sp. z o. o. sp. k.  
 82-400 Sztum  
 Gościszewo 59  
 Tel.: +48 55 272 0132  
 Fax: +48 55 272 0133  
 Tech. support: +48 55 267 0126  
 E-mail: [support@roger.pl](mailto:support@roger.pl)  
 Web: [www.roger.pl](http://www.roger.pl)