

## *Roger Access Control System*

# ADL-2 Electronic Lock

## Operating Manual

*Product hardware version: v2.0*

*Firmware version: v2.0.8.121*

*Document version: Rev. J*

### DESIGN AND APPLICATION

The ADL-2 electronic lock consists of two metal escutcheons integrated with handles. The external escutcheon has a built-in electronic reader with a keypad, which enables electronic access control. ADL-2 grants access upon entering a PIN code, reading a proximity card or use of a mobile app. Access codes can be generated remotely at [rps.roger.pl](https://rps.roger.pl) or programmed in the lock's internal memory during its configuration. Remotely generated access codes may have a validity period. The lock is operated using the Roger MDM mobile app, which, in addition to lock's configuration, enables reading of an event log saved in the lock's memory and programming of the proximity access cards. ADL-2 lock can be installed on the most doors while retaining the existing internal mortise lock and cylinder. The lock's cylinder can be used for mechanical door locking or emergency door opening. Thanks to the remotely generated codes, the lock is particularly suitable for short-term rental apartments. For integration purposes, an SDK is available that allows you to generate remote PIN codes from third-party systems.

---

**Note:** The escutcheon should be equipped with a cylinder insert. The cylinder insert is not supplied with the escutcheon. The selection and installation of the cylinder insert is the responsibility of the installer. Installing the lock without a cylinder insert is forbidden.

---

### CHARACTERISTICS

- PIN codes generated remotely in the Internet
- Email notification about newly created codes
- Validity period for remotely generated codes
- Access via PIN, proximity card or mobile app
- 20 access codes programmed in the lock's memory
- One-time use and other special codes
- Event log
- Office Mode (door temporary open)
- PIN Blacklist
- Mechanical locking and emergency opening with a traditional door key
- Powered by four AAA batteries
- Emergency power supply socket
- Typical working life of 19 months with 10 openings per day
- Brushed stainless steel lock body
- Front escutcheon dimensions: 46x280x27 mm
- Rear escutcheon dimensions: 46x280x20 mm
- Mounting with two 5x50 mm screw
- Mortise spindle 8 mm
- Lock spacing (handle-cylinder distance): 72 mm
- Door thickness: 38 to 75 mm
- SDK for generating PIN codes
- IK 07
- IP 20
- CE; RoHS

## LOCK VERSIONS

Depending on door opening direction and handle location on the door leaf, the adequate type of ADL-2 lock must be applied.

Version	Description
ADL-2-L	Left hand doors
ADL-2-R	Right hand doors

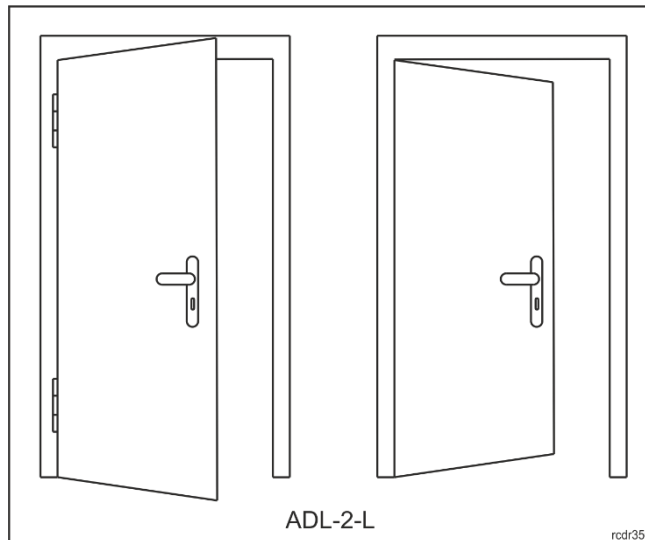

Fig. 1. Door types for ADL-2-L lock

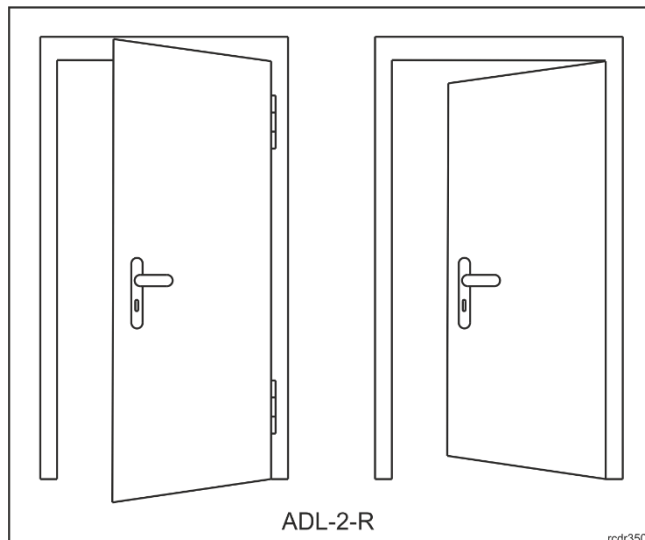

Fig. 2. Door types for ADL-2-R lock

## MECHANICAL CONSTRUCTION

The lock consists of an external escutcheon equipped with a touch keypad panel and intended to be mounted on the room entrance and an internal escutcheon containing a battery compartment and mounted on the room exit.

### External escutcheon

An electronic reader (A) with a touch keypad is in the external escutcheon. In the electronic module located in the escutcheon, there are service contacts (B) and a connector (C) for connecting the

service cable. A bundle of wires terminated with a plug (D) comes out of the electronic module, which is used to connect to the internal escutcheon. The handle on this escutcheon is free and becomes temporarily engaged when access is granted or remains permanently engaged when the lock is in Office Mode.

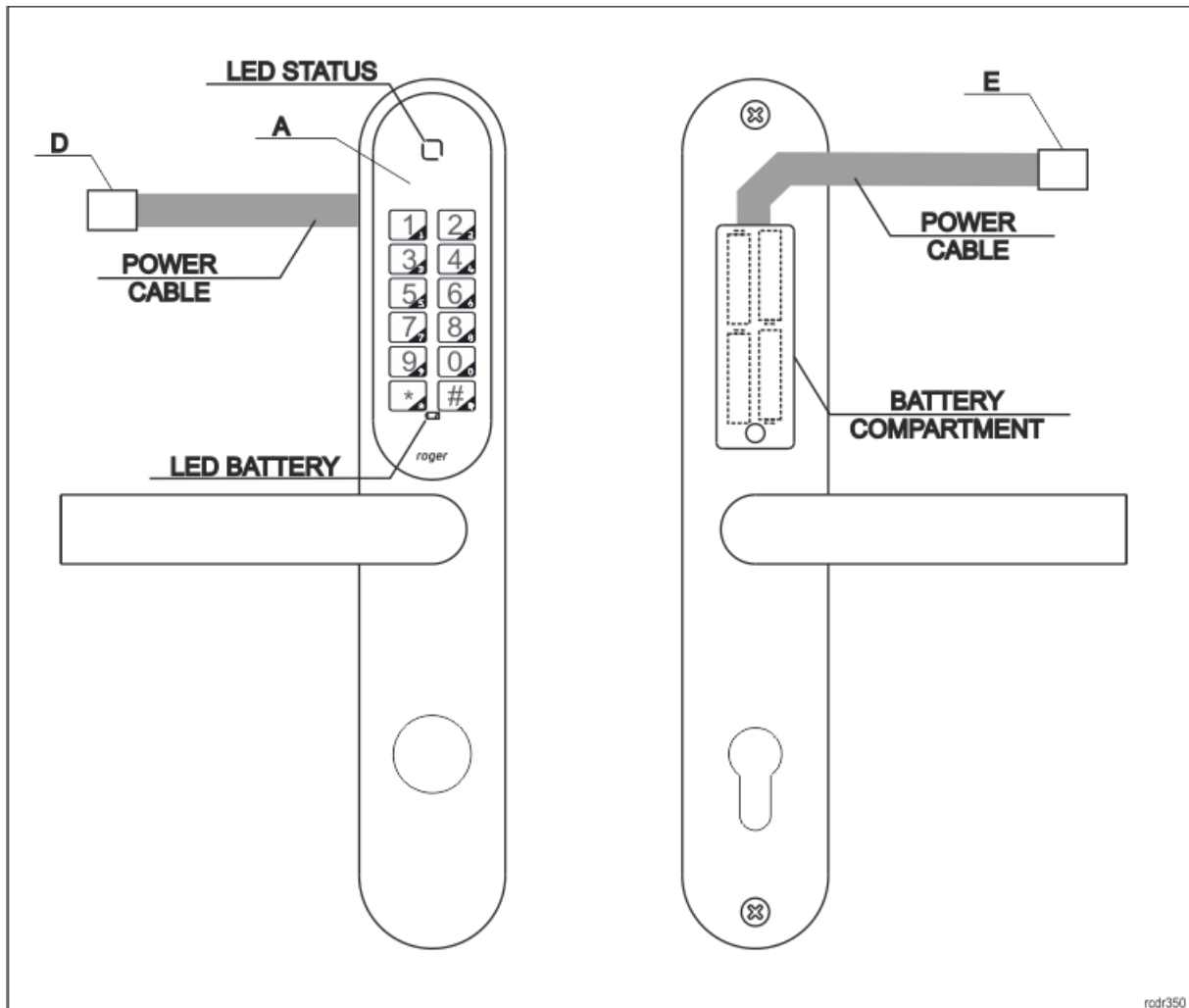

Fig. 3. External and internal escutcheons

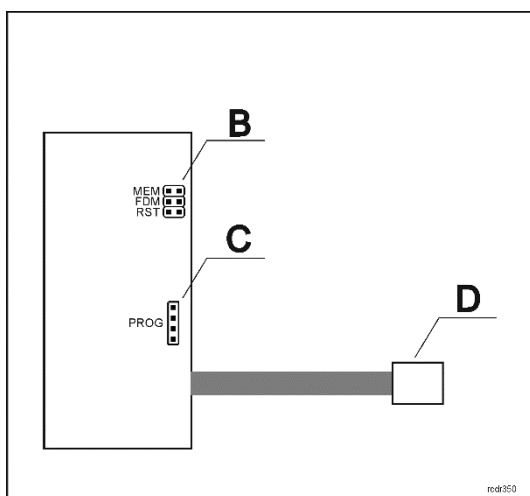

Fig. 4. Electronic module inside the escutcheon

## Internal escutcheon

Internal escutcheon includes battery pack. A bundle of wires terminated with a socket (E) comes out of the battery pack. This socket should be connected to the matching plug (D) coming out of the electronic module in the external escutcheon. To replace the battery, unscrew the cover. The handle in this escutcheon is permanently mechanically engaged and allows you to leave the room regardless of the electronic module.

## Door cylinder

ADL-2 escutcheons can be fitted with a standard cylinder lock. This cylinder enables mechanical locking of the door with a traditional mechanical key and can also be used for emergency opening of the door in case of ADL-2 failure. The size of the cylinder depends on door thickness, and it must be selected in such way that it would not protrude more than 16mm above door surface from the outside and within the range of 21-24mm from the inside. It is possible to use cylinder lock with knob.

## FUNCTIONAL DESCRIPTION

Typically, the handle in the external escutcheon is free and does not allow to open the door. Access to the room is granted after entering correct PIN. PINs can be generated remotely (on the [rps.roger.pl](http://rps.roger.pl) website) or locally by saving them in the lock's internal memory. Start entering the PIN by pressing the '\*' key and finish it with the '#' key.

E.g.: \*24376253#, \*5470235093276#.

---

Note: Normally, the lock is in sleep mode. The lock wakes up when the '\*' key is pressed. After waking up, the lock generates a short acoustic signal and lights up the LED indicator. After 30 seconds of inactivity, the lock automatically enters sleep mode.

---

Access to the room can also be granted by means of proximity card with a valid PIN saved on it, or from the level of the mobile app (RMK or Roger MDM). The PIN is saved on the card using Roger MDM app. The ADL-2 lock supports only MFC-8 (Roger) proximity cards.

The ADL-2 lock supports so-called **Office Mode**. When Office Mode is enabled, then lock is permanently unlocked (external handle is engaged) and it is not required to use access PIN for door opening.

It is possible to deactivate selected PIN by entering it on the list of blocked codes (Blacklist). PIN blocking can be achieved by using the PIN Master or from the Roger MDM app.

Depending on lock configuration, using the wrong PIN several times may temporarily block the lock. The lock can also be blocked by using the PIN Block.

## Remote PINs

Remote PINs are generated on <http://rps.roger.pl> website and they do not require lock programming.

PIN type	Description
PIN Guest 8	8-digit PIN. This PIN is valid for the selected number of days specified at the time of its generation. PIN validity period is defined with an accuracy of 1 day and limited to 365 days. PIN Guest can be blocked at any moment in the lock's configuration. Once the new PIN Guest is used the previous one is disabled.
PIN Guest 12	12-digit PIN. This PIN includes the start and end dates of its validity. When the validity period is shorter than 42 days, it is defined with an accuracy of 1 hour. If the validity period covers a period of more than 42 days, it is defined with an accuracy of 1 day. Once the new PIN Guest is used the previous one is disabled.
PIN Single	12-digit PIN. This PIN is valid for the selected number of days specified at the time of its generation. The validity period is defined with an accuracy of 1 day and limited to 365 days. Once the PIN Single is used it is automatically disabled. PIN Single allows single-time door access only.

PIN Office	12-digit PIN. This PIN has only the end of the validity period defined with an accuracy of 1 day. This PIN allows you to alternately enable and disable the Office Mode. Alternatively, Office Mode can be ended using a PIN Block.
PIN Block	12-digit PIN. This PIN allows to block previously used PIN Guest 8/PIN Guest 12. PIN Block has only the end of the validity period set with accuracy of 1 day. PIN Block does not disable neither PIN Office nor PIN Master.
PIN Service	12-digit PIN. This PIN allows to enter the room and is intended for facility service personnel. PIN Service has only the end of the validity period defined with an accuracy of 1 day.
PIN Master	12-digit PIN. This PIN allows unconditional door entry despite the blocking state caused by using the PIN Block. In addition, PIN Master allows adding the given PIN to the list of blocked codes (Blacklist). In order to block a given PIN, use the following command: *1*[PA]*[PIN]#, where [PA] is the PIN Master and [PIN] is the PIN to be blocked.

---

Note: It is recommended to set individual PIN ID for Service, Single, Office and Block PIN if they are configured with the same permissions, e.g., indefinite validity period. Individual PIN ID will allow to recognize PINs in the event log. You can generate up to 16 PINs with the same permissions.

---



---

Note: Generating PINs with an indefinite validity period is not recommended due to security reasons. In order to deactivate a PIN, it is possible to enter it on the list of blocked codes (PIN Blacklist) via the Roger MDM app. The list of blocked PINs is limited to 255 items.

---

## Shortened PINs

It is possible to generate shortened code for PIN Guest 8 and PIN Guest 12 to facilitate their use at the lock. PIN Short is a 4-to-6-digit code that can be used instead of PIN Guest but only if original PIN was entered at least once. To enable shortened PINs, the configuration parameter **Shortened PINs** must be set as 4, 5 or 6. This can be enabled in the lock using Roger MDM app or using PIN generator on the website <https://rps.roger.pl>. When generated via website than Email with both the original and shortened PINs are sent.

## Facility PINs

Access to the room can also be granted by entering Facility code. The Facility Code is a PIN that follows confidential mathematical rule. Knowing this principle, user can independently generate PINs without using [rps.roger.pl](https://rps.roger.pl) website or lock reprogramming. The algorithm for generation of Facility Codes can be available upon individual agreement with Roger company.

## Lock Integration

The ADL-2 lock can be integrated in third-party systems using the pairs module with the HTTPS protocol. Sharing the documentation requires an individual agreement with Roger company.

## Local PINs

Local PINs are generated with Roger MDM app and they are saved in lock internal memory. Up to 20 Local PINs can be saved in the lock. Local PIN can be assigned with one of the following functions:

- Normal Access
- Office Mode Control
- Door Blocking Control

To program Local PIN start Roger MDM app, long click the lock, select *Device Configuration*, and then top menu and *Local PINs*. In the opened window select  and define new PIN, its name and function. When PIN is defined then upload new settings to the lock. Local PINs are valid indefinitely and they can be deleted only with Roger MDM app.

## PIN disabling

In order to disable particular PIN enter following sequence using lock keypad: \*1\*[PIN Master] \*[PIN]#, where [PIN] is code to be blocked. For example, if 012345678912 is PIN Master then the command \*1\*012345678912\*11223344# will disable PIN 11223344. PINs can also be blocked using Roger MDM app by long clicking lock and selecting *PINs Blacklist*.

## PIN Emergency and PIN Reset

Each lock is factory programmed with two 16-digit codes: PIN Emergency and PIN Reset. PIN Emergency unconditionally opens the door while PIN Reset restores factory default settings and enables to communicate with the lock using Roger MDM app and default (empty) BLE password.

---

Note: Due to the security reasons, PIN Emergency and PIN Reset must be not revealed to any third-party person. Once revealed, it is technically not possible to block or modify such PINs.

---



---

Note: On the rps.roger.pl website, PIN Emergency and PIN Reset are masked with asterisk characters (\*\*\*\*\*\*) and they can be revealed only after contact with website admin (rpsadmin@roger.pl).

---

## PIN on proximity card

In order to save PIN on card use following command \*8\*[PIN]#, where [PIN] is a code to be saved. After entering the command, the orange LED indicator will flash and then read your proximity card (MFC-8) at the keypad. Incorrect PINs including code belonging to another lock will not be programmed.

PIN can also be saved on card using Roger MDM app, where the *Save on card* option is available in the context menu for each PIN.

Multiple PINs can be saved on the card, if they are intended to different locks. In the Roger MDM app, there is an option *Save PINs on Card*, which allows to save multiple PINs, each for different lock in the same system. Roger MDM app allows you to manage multiple systems with ADL-2 locks.

To remove the PIN from the card, on the reader to which the PIN is assigned, enter the command \*8\*0000000# (eight zeros), and then read proximity card. Alternatively, PIN can be removed from card using Roger MDM app.

## LED indicators

ADL-2 lock is equipped with two indicators: LED Status and LED Battery. LED Status is multicolour indicator (RGB) and it is used to signal various states of a lock. LED Battery is red, and it is used solely to signal low level of battery.

Signalling	Description
LED Battery	If the indicator is on after the lock wakes up, it means that its battery level is low. In such case replace the battery in reasonable time.
LED Status in on and red	LED Status is off when lock is in sleep mode. When [*] key is pressed then lock enters normal working mode and LED Status is red.
LED Status is on and green	Access is granted and it is possible to open door.
LED Status generates two red pulses	Access is denied which can result from incorrect PIN or lock being blocked by means of PIN Block.
LED Status is on and blue	Lock is communicating via BLE.
LED Status is on and orange	RTC failure. Clock must be programmed using Roger MDM app.

LED Status generates orange pulses	General lock failure. Restore factory default settings and program your lock again.
------------------------------------	---

### MANAGEMENT WITH ROGER MDM MOBILE APP

The lock is programmed using the Roger MDM mobile app (Android, iOS). The app allows you to handle many locks grouped in the so-called *Systems*. After starting the app, a list of devices saved in the last selected system is displayed. By default, all locks registered in the app are added to the system called *Default*. To detect ADL-2 locks located in the vicinity of the mobile device, select the *REGISTER IN SYSTEM* button and press the [\*] key on the lock’s keypad. From the displayed list, select detected device(s), and then add them to particular system. After selecting (clicking) a lock, it will be possible to configure it, including programming PINs. The key symbol next to the lock informs that the app has PINs programmed and they can be used to open the lock.

Note: Roger MDM app can communicate with a lock (send PIN, send configuration, etc.) only when the lock is in working mode (keypad backlight is on). Lock can be switched to working mode using [\*] key. Lock is ready to communicate with Roger MDM app when LED Status blinks in blue.

A short click on the selected device displays the list of PINs defined in the Roger MDM app for a given lock. In this situation, it is possible to open the door from the Roger MDM app. Other options are available after a long click on the device and selecting the appropriate item in the context menu.

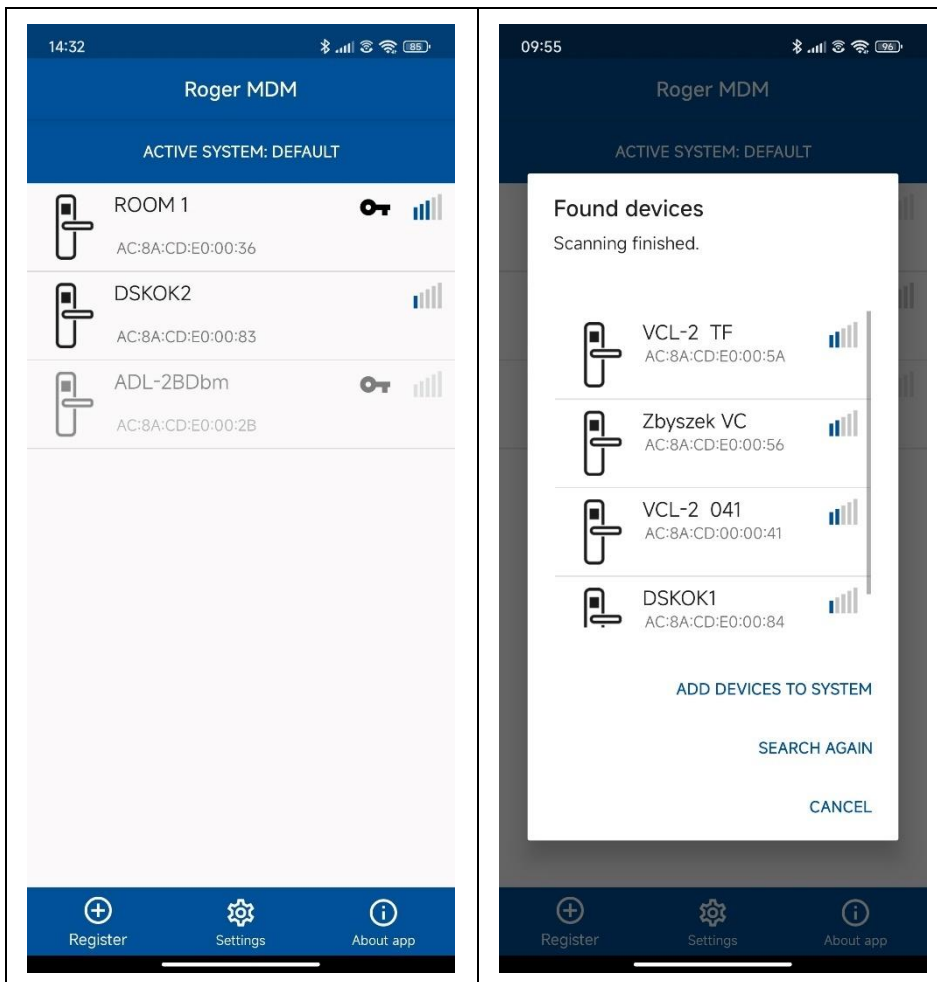

Fig. 5 List of devices in Roger MDM app (sample only)

Fig. 6 List of detected devices after scanning (sample only)

Long clicking of PIN starts context menu with following commands:

Command	Description
Edit	Command allows to modify PIN name.
Save PINs on Card	Commands is used to save PIN on proximity card so the card instead of PIN could be used for identification. Single PIN can be stored on card for particular lock and up to 32 PINs can be saved for multiple locks (only one PIN per lock).
Format Card	Command is used to remove PIN from card. Proceed according to messages displayed in the app.
Delete	Command is used to delete PIN from app (PIN is not removed from lock).





## Device Configuration

If there is no defined BLE communication password in the app then a dialog box will be displayed to enter it. When confirmed without filling any password then default password is used for communication. In case of communication errors, you may also be prompted to enter a password. Confirmation without changing the password starts communication with the device using the current password.

The Device Configuration can be edited without access to the device - in such case, the data can be saved in the app for later transfer to the lock.

If the data in the app database and in the lock do not match, you will be prompted to select the appropriate configuration (from the lock or the app) along with the date of its last editing.

The title bar in Device Configuration menu shows the following menu:

Icon	Description	
	Command saves configuration in app database and uploads it into the lock (if it is in the BLE range).	
	Command saves configuration in app database.	
	Commands:	
	Synchronize Clock	Command synchronizes lock's internal clock with mobile device clock.
	Default Settings	Command restores factory default settings for app database and lock.
	Save PINs on Card	Command saves PIN on card.
	Format Card	Command deletes all PINs from card.
	Unblock Device	Command cancels temporary blockade of lock which results from multiple entering of incorrect PIN.
	Local PINs	Command displays list of PINs which were created by user. New PIN of particular type can be added with  button and saved in app memory.

<b>Lock configuration</b>	
Parameter	Function
<b>Bluetooth settings</b>	
BLE Communication Key	Password for encryption of BLE communication. Default value: empty (no encryption).
BLE Power	BLE communication power: 1-8. The higher power the shorter is battery lifetime. Default value: 6. Note: If the reader is installed in EU countries, the BLE Power parameter should be set to 1.
Name	Lock's name (10 characters).
<b>Device settings</b>	
User Key	User key is used to encrypt PINs. Default value: empty (no encryption).
Open Time [s]	Lock release time after access granting in range of 1- 10s. Default value: 3.
PIN Attempt Limit	Number of incorrect PIN entering attempts resulting in lock blockade in range of 0-40 where 0 disables the blockade. Default value: 20.
Lockout Time [min]	Lock blocking time after incorrect PIN entering attempts resulting in lock blockade in range of 1- 20. Default value: 3 min.
Volume Level	Buzzer loudness in range of 0 - 3. Default value: 2.
Keyboard Backlight Level	Keypad backlight level in range of 0 -3. Default value: 2.
Summertime Change	Automatic adjustment of daylight-saving time. Default value: No.
PIN settings	
Enable Facility PINs	Enables Facility Codes. Default value: No.
Facility Code (0-255)	Facility Code which is individually configured for particular facility. Default value: 0.
Shortened PINs	Length of shortened PIN in range of not used, 4, 5 ,6. The parameter must be the same as on rps.roger.pl website. Default value: not in use.

### PINs Blacklist

The view displays a list of blocked PINs (maximum 255). If the list is full, adding a new code to the list removes the oldest one.

<b>Command</b>	<b>Description</b>
Add PIN	Command adds another PIN to the list of blocked PINs.
Remove expired PINs	Command removes expired PINs from Blacklist.

Remove all	Command removes all PINs from Blacklist.
------------	--

## Events

The view displays a list of events recorded in the device. It is possible to export the report in pdf format.

## Identify device

When selected then lock responds with acoustic and optical signalling. This is mainly used to identify lock among other locks.

## Delete device from list

Removes lock from the list of devices registered in the app.

## Move to another system

Moves lock to another system in the app.

## PIN using from the app

The ADL-2 lock allows the use (enter) PIN from the level of the mobile app (RMK and Roger MDM). In the Roger MDM app, clicking on the selected ADL-2 lock opens the view of the list of PINs saved in the app for the given lock. The  button in the title bar allows you to add a new PIN. In the dialog box, enter the code value (8 or 12 digits) and the name that will describe and thus facilitate the identification of a given PIN on the list. Depending on the selected option, the PIN is saved in the app database or additionally (e.g., to verify its validity) is sent to the device to release a door. Clicking on the selected PIN sends it to the lock. The lock treats the PIN sent in this way in the same way as PIN entered from the lock keypad or read from the proximity card.

## FACTORY SETTINGS RESTORE

Restoring factory settings allows you to erase the lock's internal memory, including deleting the list of blocked PINs and Local PINs as well as restoring the device's default settings. In order to restore factory settings:

- Remove jumper from MEM contacts.
- Short RST contacts for a moment.
- Place jumper on MEM contacts when LED STATUS blinks in orange and lock is generating acoustic signal.
- Three acoustic beeps are generated when lock factory settings are restored.

## MANAGEMENT WITH RPS.ROGER.PL WEBSITE

### Remotely generated PINs

Remotely generated PINs are managed from the website <https://rps.roger.pl/>. Prior to using the website, it is necessary to create user account as follows:

1. Enter rps.roger.pl address in web browser.
  2. Select **Register/New account**, enter all required information including email address and select **Register**.
  3. Open received email and click the link in order to confirm the registration.
  4. After logging at the rps.roger.pl website, define your lock selecting **Add lock** and enter lock parameters listed below. They are displayed in Device Configuration section of Roger MDM app.
- BLE MAC address: 12 HEX digits.
  - Device own name: it is recommended to use the same name as in Roger MDM app. This name will also be used in RMK app.
  - Option **Save user key**: when enabled then User key is stored in website database.
  - User key which is used to encrypt PINs for lock.
  - Shortened PINs: parameter defines the length of shortened PINs which can be used instead of PIN Guest 8 and PIN Guest 12. If length is undefined then shortened PINs are disabled.

- PIN RESET - for verification: it is a unique PIN code of the lock, which is in the envelope  
Factory codes of the lock

Note: When Save user key option is enabled then the key is saved in the website database, and it is automatically filled when new PIN is defined. Nevertheless, despite the strict security measures which are applied at rps.roger.pl website, there is always a risk that the User Key will be stolen as a result of breaking the website's security. Therefore, for security reasons, it is recommended not to enable this option.

Note: Due to security reasons it is recommended to register ADL-2 lock at rps.roger.pl website immediately after purchase to prevent the registration of your lock by unauthorized who knows the BLE MAC number of your lock.

#### Add lock

BLE MAC	<input type="text" value="12 hex digits 0..9, A..F"/>
Name	<input type="text" value="1-10 chars a..z, A..Z, 0..9"/>
Save user key	<input type="checkbox"/>
User Key	<input type="text" value="16 hex digits 0..9, A..F"/>
Shortened PIN	<input type="text" value="No use"/>
Comment	<input type="text"/>
PIN RESET for verification	<input type="text" value="16 digits 0..9"/>

The button **General settings** enables to define common settings for all locks including email address for notifications related to defined PINs.

### General Settings

Mail Addresses (comma separated)

Send Mail After PIN Creation

Lock description

The button **PIN codes** is used to manage PINs for lock.

When new lock is added then only factory PINs are displayed such as PIN Emergency and PIN Reset but they are masked with asterisk characters. They can be unmasked after contacting with website administrator and confirming user identity. When unmasked they can be displayed when mouse cursor is placed on them.

New PIN is generated after selection of Add new PIN. When such PIN is defined then its type, associated email address for further notifications can be entered.

**roger** Intelligence for Building ADL-2 locks Account settings syzkaczewski@roger.pl Log out

PINs generated for device Room 2 [AC 8A CD E0 00 36]

Add new PIN code
Delete disabled PINs

Code no	Code type	Start date	Stop date	PIN	Shortened PIN
2	PIN Guest 12	2023-07-11 00:00	2023-07-12 00:59	*0879 4896 7627#	*2233#
1	PIN Guest 8	No limit	2023-07-12 23:59	*3140 0181#	*9582#
	PIN Emergency	No limit	No limit		
	PIN Reset	No limit	No limit		

©2023 Roger, v1.0.1.18

### Add new PIN code

---

Code type

PIN Guest 12

Begin date: 11.07.2023

Begin hour: 0:00

End date: 12.07.2023

End hour: 0:59

Guest mail address

Recipient mail address (eg. james@roger.pl,bond@ama.com)

---

Save Close

### Add new PIN code

---

Code type

PIN Office

Valid indefinitely

End date: 11.07.2023

End hour: 23:59

Guest mail address

Recipient mail address (eg. james@roger.pl,bond@ama.com)

---

Save Close

The button **Delete disabled PINs** deletes all expired PINs from the database.

## INSTALLATION

The ADL-2 lock is designed for mounting on door with 38 to 75mm thickness, with mortise lock installed and with 72mm handle spacing. Prior to installation make sure that door cylinder is long enough. The lock is delivered with two handle pins and two sets of bolts with different length. In case of door with 55mm or greater thickness, longer bolts should be used.

### Power supply

Lock is supplied from 4 x AAA batteries. Assuming 10 openings per day and the BLE Broadcast Period option is set to 2500 ms, a set of new alkaline batteries will last for about 19 months of device operation. If the parameter is changed to 600ms, a set of new alkaline batteries will last for about 6 months of device operation. The BLE Broadcast Period parameter is set from the Roger MDM app. If the battery voltage drops below approx. 4.5 VDC, the lock will activate Low Battery LED (Fig. 2) into red colour for a 3 s. This indication will be repeated after each activation of the lock. Additionally, the low battery level is signalled in the Roger MDM app by the Battery Level parameter. From the moment the low battery signal is switched on, the lock should allow at least 100 more opening cycles.

---

Note: Do not postpone replacing the battery pack if the lock is already indicating a low battery level.

---

## Lock installation

- Make holes in door using drilling template.
- Lead battery wires (fig. 3, pos. E) through hole and then connect with wires from external part of lock (pos. D).
- Make sure that handle pin hole is positioned in such way that marker (red dot) indicates door top hinge (fig. 7) and then install handle pin inside the lock.
- Install 4 x AAA batteries in the pack.
- Mount escutcheon and verify the operation of internal handle and door cylinder, particularly if handle latch is retracted when metal key is used.

---

Note: The cylinder insert allows you to lock the door with a key. For safety reasons, the lock should be equipped with a cylinder that will enable the door to be opened in the event of an electronic control failure. The end user should be trained in the rules of emergency door opening and informed about the need to secure access to the key in emergency situations.

---

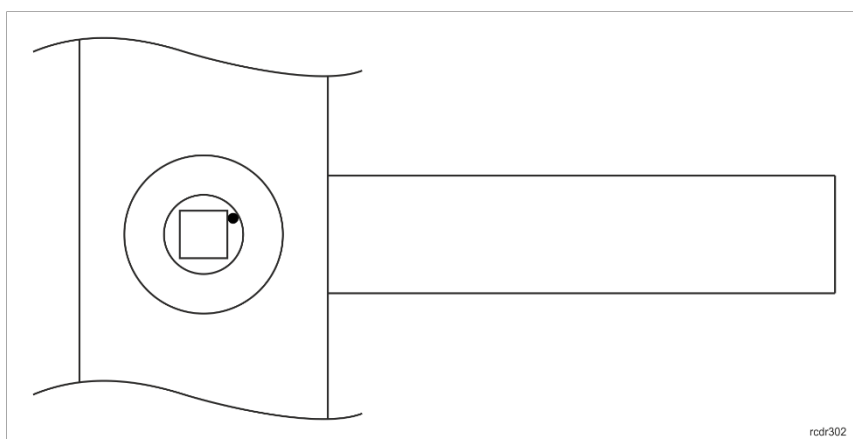

Fig. 7. Proper installation of handle mechanism

## INSTALLATION GUIDELINES

- The ADL-2 lock should be mounted on the door leaf away from sources of heat and moisture.
- In particular, it is not allowed to install the ADL-2 lock in places with high humidity such as saunas, swimming pools, car washes, etc.
- The device can be cleaned periodically with a slightly damp cloth and mild detergents that do not contain abrasive substances. In particular, do not use alcohol, solvents, petrol, disinfectants, acids, rust removers, etc. for cleaning. Damage resulting from improper maintenance or improper use is not covered by the warranty.
- The mortise lock should have a hole for 8 mm spindle.
- The set includes M5 screws with a 3 mm hexagon head.
- The escutcheons should be screwed together with the screws provided with a force of 1.5 Nm.

## SPECIFICATION

Parameter	Value
Power supply	4 x AAA (LR03) alkaline batteries
Battery life	Typical operation time with 10 opening cycles per day – 19 months Typical operation time with 20 opening cycles per day – 17 months Typical operation time with 40 opening cycles per day – 14 months Typical operation time with 80 opening cycles per day – 10 months Typical operation time with 160 opening cycles per day – 6 months

	Note: Battery life time is specified for Energizer Industrial LR03 alkaline batteries with a capacity of 1200mAh and may vary depending on the specific type of battery and the way the lock is used.
Door thickness	38 – 75 mm
Handle spacing	72 mm
Mortise Spindle	8 mm
Built-in card reader	ISO/IEC 14443A MIFARE® card reader for MFC-8 (Roger) proximity cards
Environmental class (acc. to EN 50131-1)	Class I, indoor general conditions, temperature: +5°C to +40°C, relative humidity: 10 to 95% (no condensation)
IK code	IK 07
IP code	IP 20
Dimensions	47x280 mm
Weight	~1,1 kg
Certificates	CE; RoHS

## ORDERING INFORMATION

Product	Description
ADL-2-L	Electronic escutcheon; access by PIN, proximity card or mobile app; PIN codes generated remotely or programmed in lock's memory; four AAA battery supply; left hand version, normal or reverse bevel
ADL-2-R	Electronic escutcheon; access by PIN, proximity card or mobile app; PIN codes generated remotely or programmed in lock's memory; four AAA battery supply; right hand version, normal or reverse bevel
MFC-8	Proximity card for ADL-2 locks

## PRODUCT HISTORY

Version	Date	Description
1.0	2021/06	The first commercial version of product
2.0	2023/05	The second commercial version of product

	<p>This symbol placed on a product or packaging indicates that the product should not be disposed of with other wastes as this may have a negative impact on the environment and health. The user is obliged to deliver equipment to the designated collection points of electric and electronic waste. For detailed information on recycling, contact your local authorities, waste disposal company or point of purchase. Separate collection and recycling of this type of waste contributes to the protection of the natural resources and is safe to health and the environment. Weight of the equipment is specified in the document.</p>
---	---

**Contact:****Roger Sp. z o. o. sp. k.****82-400 Gościszewo 59****Tel.: +48 55 272 0132****Fax: +48 55 272 0133****Tech. support: +48 55 267 0126****E-mail: [biuro@roger.pl](mailto:biuro@roger.pl)****Web: [www.roger.pl](http://www.roger.pl)**